

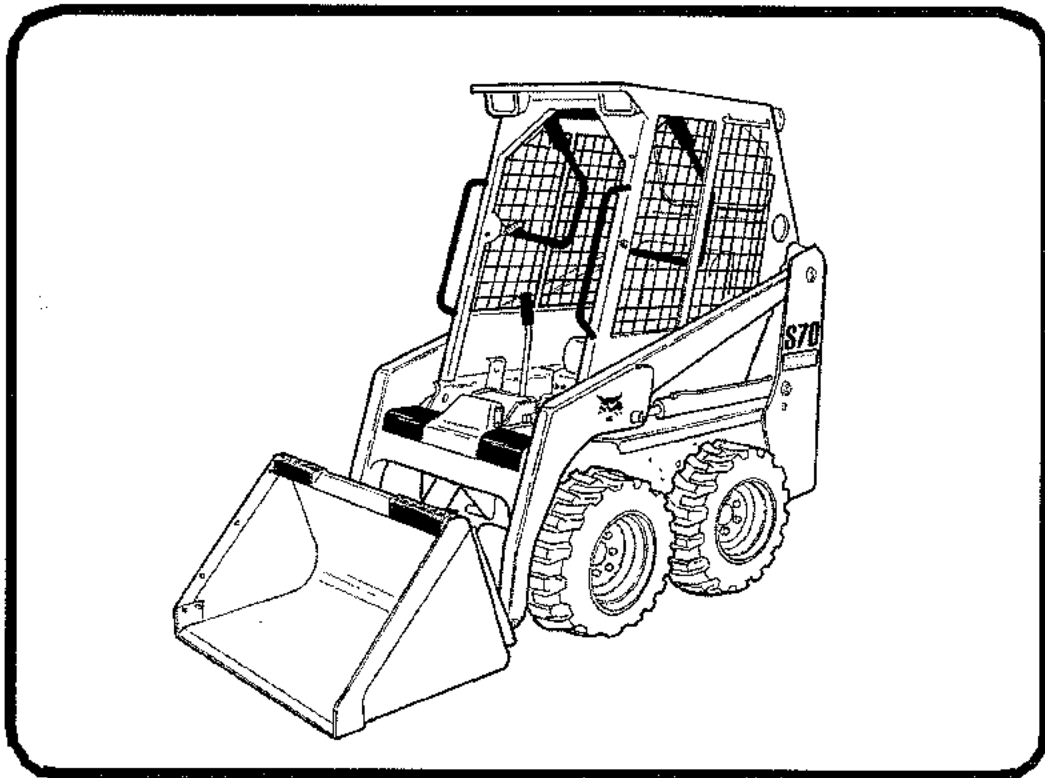

Bobcat®

Operation & Maintenance Manual S70 Skid-Steer Loader

S/N A3W611001 & Above
S/N A3W711001 & Above
S/N B38V11001 & Above



EQUIPPED WITH
BOBCAT INTERLOCK
CONTROL SYSTEM (BICS™)





OPERATOR SAFETY WARNINGS



WARNING

Operator must have instructions before operating the machine. Untrained operators can cause injury or death.

W-2001-0502



Safety Alert Symbol: This symbol with a warning statement, means: "Warning, be alert! Your safety is involved!" Carefully read the message that follows.

CORRECT

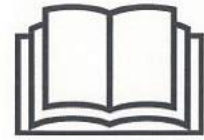

P-90216

⚠ Never use the loader without instructions. See machine signs (decals), Operation & Maintenance Manual, and Operator's Handbook.



CORRECT

B-7403

⚠ Always use the seat bar and fasten seat belt snugly.
⚠ Always keep feet on the foot pedals or footrests when operating loader.



CORRECT

B-6582

⚠ Never use loader without operator cab with ROPS and FOPS approval. Fasten your seat belt.

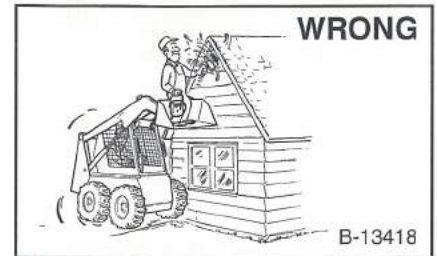

WRONG

B-13418

⚠ Never use loader as man lift or elevating device for personnel.



WRONG

B-6578

⚠ Do not use loader in atmosphere with explosive dust, explosive gas, or where exhaust can contact flammable material.



WRONG

B-6585

⚠ Never carry riders.
⚠ Keep bystanders away from work area.



WRONG

B-6595

⚠ Always carry bucket or attachments as low as possible.
⚠ Do not travel or turn with lift arms up.
⚠ Load, unload, and turn on flat level ground.

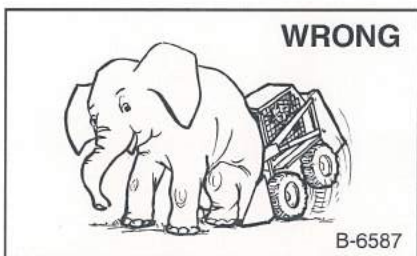

WRONG

B-6587

⚠ Never exceed Rated Operating Capacity.



WRONG

B-6594

⚠ Never leave loader with engine running or with lift arms up.
⚠ To park, engage parking brake and put attachment flat on the ground.

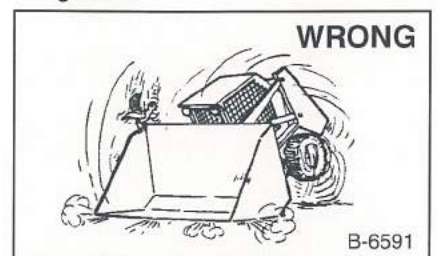

WRONG

B-6591

⚠ Never modify equipment.
⚠ Use only attachments approved by Bobcat Company for this model loader.

SAFETY EQUIPMENT

The Bobcat Loader must be equipped with safety items necessary for each job. Ask your dealer for information on the safe use of attachments and accessories.

1. SEAT BELT: Check belt fasteners and check for damaged webbing or buckle.
2. SEAT BAR: When up, it must lock the loader controls.
3. OPERATOR CAB (ROPS and FOPS): It must be on the loader with all fasteners tight.
4. OPERATOR'S HANDBOOK: Must be in the cab.
5. SAFETY SIGNS (DECALS): Replace if damaged.
6. SAFETY TREADS: Replace if damaged.
7. GRAB HANDLES: Replace if damaged.
8. LIFT ARM SUPPORT DEVICE: Replace if damaged.
9. PARKING BRAKE
10. BOBCAT INTERLOCK CONTROL SYSTEM (BICS)



Bobcat®

CONTENTS

FOREWORD	5
SAFETY AND TRAINING RESOURCES	13
OPERATING INSTRUCTIONS	23
PREVENTIVE MAINTENANCE	65
SYSTEM SETUP AND ANALYSIS	109
MACHINE SIGN TRANSLATIONS	115
SPECIFICATIONS	127
WARRANTY	133
ALPHABETICAL INDEX	137

REFERENCE INFORMATION

Write the correct information for YOUR Bobcat loader in the spaces below. Always use these numbers when referring to your Bobcat loader.

Loader Serial Number B38V14544
Engine Serial Number 01005-1HA5426

NOTES:

~~YOUR BOBCAT DEALER:~~

Burgo's Equipment Hire
ADDRESS:

118-120 Mount Lindesay Hwy, Gleneagle QLD 4285
PHONE:

0448 665 010 0437 183 777

Bobcat Company
P.O. Box 128
Gwinner, ND 58040-0128
UNITED STATES OF AMERICA

Doosan Benelux SA
Drève Richelle 167
B-1410 Waterloo
BELGIUM



Bobcat®

FOREWORD

This Operation & Maintenance Manual was written to give the owner / operator instructions on the safe operation and maintenance of the Bobcat loader. **READ AND UNDERSTAND THIS OPERATION & MAINTENANCE MANUAL BEFORE OPERATING YOUR BOBCAT LOADER.** If you have any questions, see your Bobcat dealer. This manual may illustrate options and accessories not installed on your loader.

BOBCAT COMPANY IS ISO 9001 CERTIFIED	7
REGULAR MAINTENANCE ITEMS	7
SERIAL NUMBER LOCATIONS	8
Loader Serial Number	8
Engine Serial Number	8
DELIVERY REPORT	8
LOADER IDENTIFICATION	9
FEATURES, ACCESSORIES AND ATTACHMENTS	10
Standard Items	10
Options And Accessories	10
Buckets Available	11
Attachments	11
Special Applications Kit	12
Special Applications Kit Inspection And Maintenance	12



Bobcat®

BOBCAT COMPANY IS ISO 9001 CERTIFIED











ISO 9001 is an international standard that specifies requirements for a quality management system that controls the processes and procedures which we use to design, develop, manufacture and distribute Bobcat products.

British Standards Institute (BSI) is the Certified Registrar Bobcat Company chose to assess the Company's compliance with the ISO 9001 at Bobcat's manufacturing facilities in Gwinner and Bismarck, North Dakota (U.S.A.), Pontchateau (France), Dobris (Czech Republic) and the Bobcat corporate offices (Gwinner, Bismarck & West Fargo) in North Dakota. Only certified assessors, like BSI, can grant registrations.

ISO 9001 means that as a company we say what we do and do what we say. In other words, we have established procedures and policies, and we provide evidence that the procedures and policies are followed.

CALIFORNIA PROPOSITION 65 WARNING
 Diesel engine exhaust and some of its constituents are known to the State of California to cause cancer, birth defects and other reproductive harm.

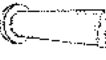
REGULAR MAINTENANCE ITEMS

	ENGINE OIL FILTER (6 Pack) 6657635		BREATHER CAP 7025626
	FUEL FILTER 6667352		BATTERY 6674687
	AIR FILTER, Outer 6672467		FLUID, Hydraulic / Hydrostatic 6903117 - (2.5 U.S. gal) 6903118 - (5 U.S. gal) 6903119 - (55 U.S. gal)
	AIR FILTER, Inner 6672468		
	HYDROSTATIC FILTER 6677652		ANTI-FREEZE, Propylene Glycol 6983128 - Premixed 6983129 - Concentrate
ENGINE OIL 7023080 SAE 15W40 CE/SG (12 qt) 7023076 SAE 10W30 CE/SG (12 qt) 6903109 SAE 30W CE/SG (12 qt) 7023082 SAE 15W40 CE/SG (2.5 U.S. gal) 7023078 SAE 10W30 CE/SG (2.5 U.S. gal) 6903111 SAE 30W CE/SG (2.5 U.S. gal)		ENGINE OIL 7023081 SAE 15W40 CE/SG (1 U.S. gal) 7023077 SAE 10W30 CE/SG (1 U.S. gal) 6903110 SAE 30W CE/SG (1 U.S. gal)	

NOTE: Always verify Part Numbers with your Bobcat dealer.

SERIAL NUMBER LOCATIONS

Always use the serial number of the loader when requesting service information or when ordering parts. Early or later models (identification made by serial number) may use different parts, or it may be necessary to use a different procedure in doing a specific service operation.

Loader Serial Number

Figure 1

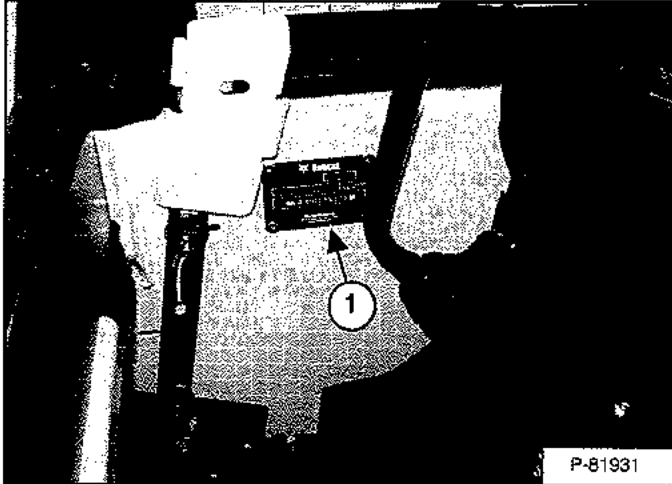

The loader serial number plate (Item 1) [Figure 1] is located inside the cab on the right-hand side.

Figure 2

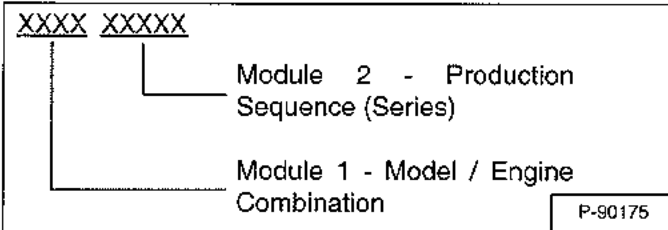

Explanation of loader Serial Number [Figure 2]:

1. The four digit Model / Engine Combination Module number identifies the model number and engine combination.
2. The five digit Production Sequence Number identifies the order which the loader is produced.

Engine Serial Number

Figure 3

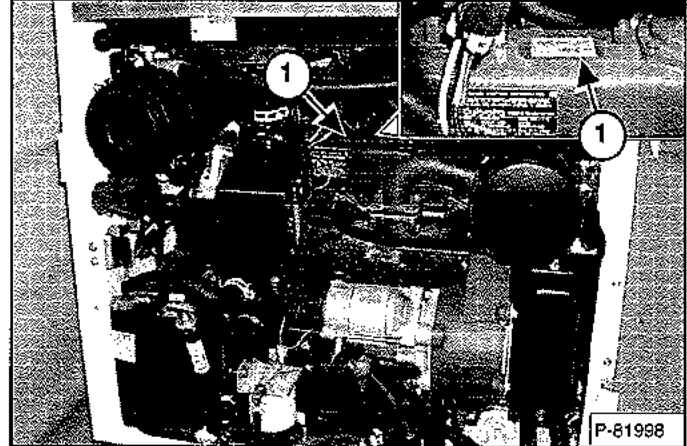

The engine serial number is located on top of the engine (Item 1) [Figure 3].

DELIVERY REPORT

Figure 4

The delivery report [Figure 4] contains a list of items that must be explained or shown to the owner or operator by the dealer when the Bobcat loader is delivered.

The delivery report must be reviewed and signed by the owner or operator and the dealer.

LOADER IDENTIFICATION

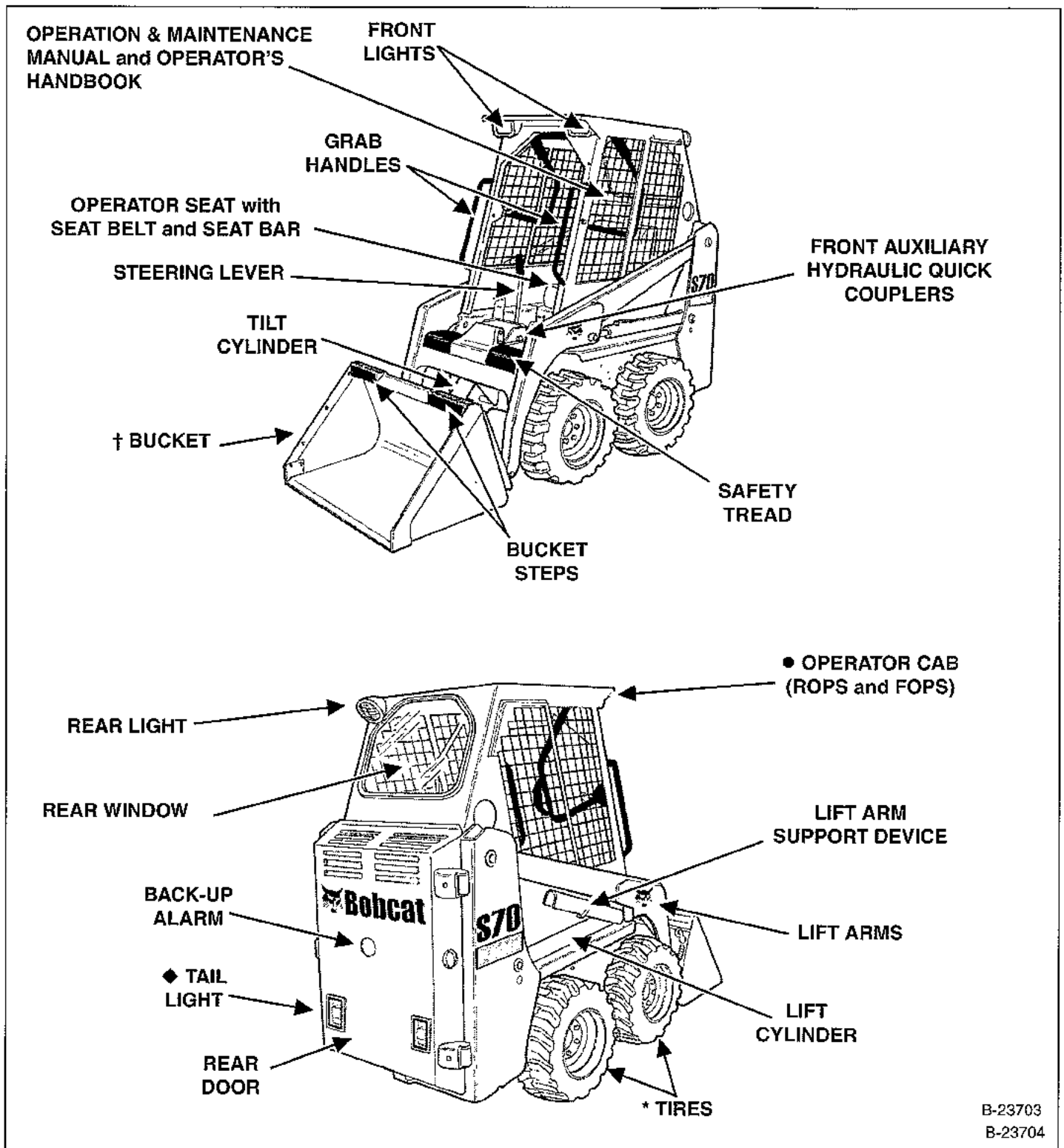

◆ OPTIONAL OR FIELD ACCESSORY (Not Standard Equipment).

* TIRES - Bobcats are base-equipped with standard tires.

† BUCKET - Several different buckets and other attachments are available for the Bobcat Loader.

● ROPS - Roll-Over Protective Structure per ISO 3471 and FOPS - Falling-Object Protective Structure per ISO 3449, Level I.

FEATURES, ACCESSORIES AND ATTACHMENTS

Standard Items

Model S70 Bobcat Loaders are equipped with the following standard items:

- Adjustable Cushion Seat
- Auxiliary Hydraulics, Front
- Bobcat Interlock Control System (BICS™)
- Bob-Tach™
- Front Horn / Back-up Alarm
- Instrumentation: Hourmeter, Engine Temperature and Warning Lights
- Lift Arm Support Device
- Lights, Front and Rear
- Operator Cab (ROPS and FOPS [Level I] Approved)
- Parking Brake
- Rear Window
- Seat Bar
- Seat Belt
- Spark Arrester Exhaust System
- Tires (Bobcat Standard Duty, 23 x 5.70 - 12, 4 PR)
- Work Lights - Rear

Options And Accessories

Below is a list of some equipment available from your Bobcat Loader dealer as Dealer and / or Factory Installed Accessories and Factory Installed Options. See your Bobcat dealer for other available options, accessories and attachments.

- Adjustable Suspension Seat
- Attachment Control Kit
- Cab Door
- Cab Enclosure
- Cab Heater
- Catalytic Exhaust Purifier
- Dual Steering Damper
- Engine Heater
- Extended Pedals
- GPS System
- Hydraulic Bucket Positioning (Includes On/Off Selection)
- Keyless Start
- Lift Kit (For lifting entire loader)
- Locking Fuel Cap and Cover
- Rear Stabilizer Kit
- Rental Kit (Monitors Temperature and Pressure [Engine Oil and Hydraulic Oil])
- Rotating Beacon
- Seat Belt - 3 in. Wide
- Sound Reduction Kit (Reduces noise at operator ear)
- Special Applications Kit
- Strobe Light
- Tires:
 - Bobcat Heavy Duty, 23 x 8.50 - 12, 6 PR
- Tool Container
- Vinyl Cab Enclosure
- Warning Lights: Four-Way Flasher (Includes Direction Signals)
- Windows
 - Externally Removable Rear Window
 - Polycarbonate Rear Window
 - Side Windows
 - Top Window

Specifications subject to change without notice and standard items may vary.

FEATURES, ACCESSORIES AND ATTACHMENTS (CONT'D)

These and other attachments are approved for use on this model loader. Do not use unapproved attachments. Attachments not manufactured by Bobcat may not be approved.

The versatile Bobcat Loader quickly turns into a multi-job machine with a tight-fit attachment hook-up ... from bucket to grapple to pallet fork to backhoe and a variety of other attachments.

See your Bobcat dealer for information about approved attachments and attachment Operation & Maintenance Manuals.

Increase the versatility of your Bobcat Loader with a variety of bucket styles and sizes.

Buckets Available

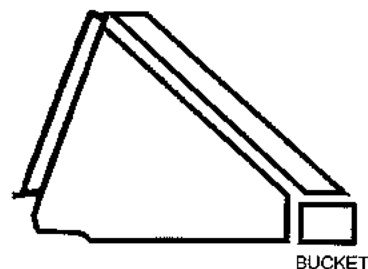

Many bucket styles, widths and different capacities are available for a variety of different applications. They include Construction & Industry, Low profile, Fertilizer and Snow, to name a few. See your Bobcat dealer for the correct bucket for your Bobcat Loader and application.

Attachments

- Angle Broom
- Auger
- Backhoe
- Blades
 - Utility Blade
 - V-Blade
- Boring Unit
- Buckets
- Combination Bucket
- Digger
- Dumping Hopper
- Grapple
 - Industrial
 - Root
 - Utility
- Hydraulic Breaker
- Landplane
- Pallet Fork
- Scraper
- Snowblower
- Soil Conditioner
- Stump Grinder
- Sweeper
- Tiller
- Tree Fork
- Trencher
- Utility Forks
- Vibratory Plow
- X-Change™ Frame

WARNING

AVOID INJURY OR DEATH

Some attachment applications can cause flying debris or objects to enter front, top or rear cab openings. Install the Special Applications Kit to provide added operator protection in these applications.

W-2737-0508

Special Applications Kit Inspection And Maintenance

- Inspect for cracks or damage. Replace if required.
- Pre-rinse with water to remove gritty materials.
- Wash with a mild household detergent and warm water.
- Use a sponge or soft cloth. Rinse well with water and dry with a clean soft cloth or rubber squeegee.
- Do not use abrasive or highly alkaline cleaners.
- Do not clean with metal blades or scrapers.

Special Applications Kit

Figure 5

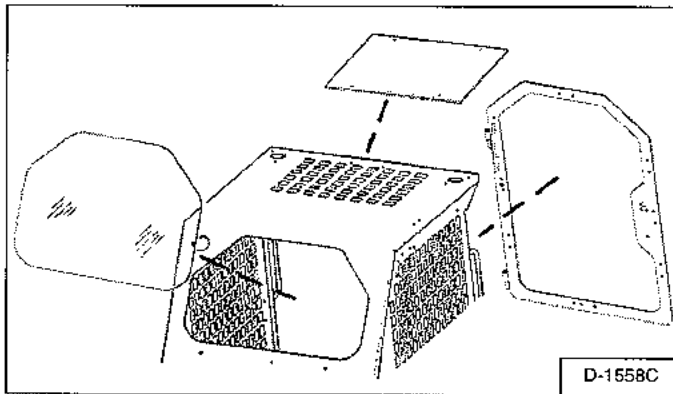

Available for special applications to restrict material from entering cab openings. Kit includes 12,7 mm (0.5 in) thick polycarbonate front door, 6,4 mm (0.25 in) thick polycarbonate top and rear windows [Figure 5].

See your Bobcat dealer for availability.

SAFETY AND TRAINING RESOURCES

SAFETY INSTRUCTIONS	15
Before Operation	15
Safe Operation Is The Operator's Responsibility	16
Safe Operation Needs A Qualified Operator	16
Avoid Silica Dust	17
FIRE PREVENTION	17
Maintenance	17
Operation	17
Electrical	17
Hydraulic System	18
Fueling	18
Starting	18
Spark Arrester Exhaust System	18
Welding And Grinding	18
Fire Extinguishers	18
MACHINE SIGNS (DECALS)	20
PUBLICATIONS AND TRAINING RESOURCES	22



Bobcat®

SAFETY INSTRUCTIONS

Before Operation

Carefully follow the operating and maintenance instructions in this manual.

The Bobcat loader is highly maneuverable and compact. It is rugged and useful under a wide variety of conditions. This presents an operator with hazards associated with off highway, rough terrain applications, common with Bobcat loader usage.

The Bobcat loader has an internal combustion engine with resultant heat and exhaust. All exhaust gases can kill or cause illness so use the loader with adequate ventilation.

The dealer explains the capabilities and restrictions of the Bobcat loader and attachment for each application. The dealer demonstrates the safe operation according to Bobcat instructional materials, which are also available to operators. The dealer can also identify unsafe modifications or use of unapproved attachments. The attachments and buckets are designed for a Rated Operating Capacity (some have restricted lift heights). They are designed for secure fastening to the Bobcat loader. The user must check with the dealer, or Bobcat literature, to determine safe loads of materials of specified densities for the machine - attachment combination.

The following publications and training materials provide information on the safe use and maintenance of the Bobcat machine and attachments:

- The Delivery Report is used to assure that complete instructions have been given to the new owner and that the machine and attachment is in safe operating condition.
- The Operation & Maintenance Manual delivered with the machine or attachment gives operating information as well as routine maintenance and service procedures. It is a part of the machine and can be stored in a container provided on the machine. Replacement Operation & Maintenance Manuals can be ordered from your Bobcat dealer.
- Machine signs (decals) instruct on the safe operation and care of your Bobcat machine or attachment. The signs and their locations are shown in the Operation & Maintenance Manual. Replacement signs are available from your Bobcat dealer.

- An Operator's Handbook is fastened to the operator cab of the loader. It's brief instructions are convenient to the operator. The handbook is available from your dealer in an English edition or one of many other languages. See your Bobcat dealer for more information on translated versions.
- The AEM Safety Manual delivered with the machine gives general safety information.
- The Skid-Steer Loader Operating Training Course is available through your Bobcat dealer. This course is intended to provide rules and practices of correct operation of the Bobcat loader. The course is available in English and Spanish versions.
- Service Safety Training Courses are available from your Bobcat dealer. They provide information for safe and correct service procedures.
- See the PUBLICATIONS AND TRAINING RESOURCES Page in this manual or your Bobcat dealer for Service and Parts Manuals, printed materials, videos, or training courses available. Also check the Bobcat web sites www.training.bobcat.com or www.bobcat.com

The dealer and owner / operator review the recommended uses of the product when delivered. If the owner / operator will be using the machine for a different application(s) he or she must ask the dealer for recommendations on the new use.



Call Before You Dig
Dial 811 (USA Only)
1-888-258-0808 (USA & Canada)

When you call, you will be directed to a location in your state / province, or city for information about buried lines (telephone, cable TV, water, sewer, gas, etc.).

SI SSL-0913

SAFETY INSTRUCTIONS (CONT'D)

Safe Operation Is The Operator's Responsibility



Safety Alert Symbol

This symbol with a warning statement means:
"Warning, be alert! Your safety is involved!"
Carefully read the message that follows.



WARNING

Operator must have instructions before operating the machine. Untrained operators can cause injury or death.

W-2001-1285

IMPORTANT

This notice identifies procedures which must be followed to avoid damage to the machine.

I-2019-0284



DANGER

The signal word DANGER on the machine and in the manuals indicates a hazardous situation which, if not avoided, will result in death or serious injury.

D-1002-1107



WARNING

The signal word WARNING on the machine and in the manuals indicates a potentially hazardous situation which, if not avoided, could result in death or serious injury.

W-2044-1107

The Bobcat loader and attachment must be in good operating condition before use.

Check all of the items on the Bobcat Service Schedule Decal under the 8-10 hour column or as shown in the Operation & Maintenance Manual.

Safe Operation Needs A Qualified Operator

For an operator to be qualified, he or she must not use drugs or alcoholic drinks which impair alertness or coordination while working. An operator who is taking prescription drugs must get medical advice to determine if he or she can safely operate a machine.

A Qualified Operator Must Do The Following:

Understand the Written Instructions, Rules and Regulations

- The written instructions from Bobcat Company include the Delivery Report, Operation & Maintenance Manual, Operator's Handbook, Safety Manual and machine signs (decals).
- Check the rules and regulations at your location. The rules may include an employer's work safety requirements. Regulations may apply to local driving requirements or use of a Slow Moving Vehicle (SMV) emblem. Regulations may identify a hazard such as a utility line.

Have Training with Actual Operation

- Operator training must consist of a demonstration and verbal instruction. This training is given by your Bobcat dealer before the product is delivered.
- The new operator must start in an area without bystanders and use all the controls until he or she can operate the machine and attachment safely under all conditions of the work area. Always fasten seat belt before operating.
- Operator Training Courses are available from your Bobcat dealer in English and Spanish. They provide information for safe and efficient equipment operation. Safety videos are also available.
- Service Safety Training Courses are available from your Bobcat dealer. They provide information for safe and correct service procedures.

Know the Work Conditions

- Know the weight of the materials being handled. Avoid exceeding the Rated Operating Capacity (ROC) of the machine. Material which is very dense will be heavier than the same volume of less dense material. Reduce the size of the load if handling dense material.
- The operator must know any prohibited uses or work areas, for example, he or she needs to know about excessive slopes.
- Know the location of any underground lines. Call local utilities or the TOLL FREE phone number found in the *Before Operation* section of this manual.
- Wear tight fitting clothing. Always wear safety glasses when doing maintenance or service. Safety glasses, respiratory equipment, hearing protection or Special Applications Kits are required for some work. See your Bobcat dealer about Bobcat safety equipment for your model.

SI SSL-0913

SAFETY INSTRUCTIONS (CONT'D)

Avoid Silica Dust



Cutting or drilling concrete containing sand or rock containing quartz may result in exposure to silica dust. Do not exceed Permissible Exposure Limits (PEL) to silica dust as determined by OSHA or other job site Rules and Regulations. Use a respirator, water spray or other means to control dust. Silica dust can cause lung disease and is known to the state of California to cause cancer.

FIRE PREVENTION



Maintenance

The machine and some attachments have components that are at high temperatures under normal operating conditions. The primary source of high temperatures is the engine and exhaust system. The electrical system, if damaged or incorrectly maintained, can be a source of arcs or sparks.

Flammable debris (leaves, straw, etc.) must be removed regularly. If flammable debris is allowed to accumulate, it can cause a fire hazard. Clean often to avoid this accumulation. Flammable debris in the engine compartment is a potential fire hazard.

The operator's area, engine compartment and engine cooling system must be inspected every day and cleaned if necessary to prevent fire hazards and overheating.

All fuels, most lubricants and some coolant mixtures are flammable. Flammable fluids that are leaking or spilled onto hot surfaces or onto electrical components can cause a fire.

Operation

Do not use the machine where exhaust, arcs, sparks or hot components can contact flammable material, explosive dust or gases.

Electrical



Check all electrical wiring and connections for damage. Keep the battery terminals clean and tight. Repair or replace any damaged part or wires that are loose or frayed.

Battery gas can explode and cause serious injury. Use the procedure in the Operation & Maintenance Manual for connecting the battery and for jump starting. Do not jump start or charge a frozen or damaged battery. Keep any open flames or sparks away from batteries. Do not smoke in battery charging area.

SI SSL-0913

FIRE PREVENTION (CONT'D)

Hydraulic System

Check hydraulic tubes, hoses and fittings for damage and leakage. Never use open flame or bare skin to check for leaks. Hydraulic tubes and hoses must be properly routed and have adequate support and secure clamps. Tighten or replace any parts that show leakage.

Always clean fluid spills. Do not use gasoline or diesel fuel for cleaning parts. Use commercial nonflammable solvents.

Fueling



Stop the engine and let it cool before adding fuel. No smoking! Do not refuel a machine near open flames or sparks. Fill the fuel tank outdoors.

Ultra Low Sulfur Diesel (ULSD) poses a greater static ignition hazard than earlier diesel formulations with higher Sulfur content. Avoid death or serious injury from fire or explosion. Consult with your fuel or fuel system supplier to ensure the delivery system is in compliance with fueling standards for proper grounding and bonding practices.

Starting

Do not use ether or starting fluids on any engine that has glow plugs or air intake heater. These starting aids can cause explosion and injure you or bystanders.

Use the procedure in the Operation & Maintenance Manual for connecting the battery and for jump starting.

Spark Arrester Exhaust System

The spark arrester exhaust system is designed to control the emission of hot particles from the engine and exhaust system, but the muffler and the exhaust gases are still hot.

Check the spark arrester exhaust system regularly to make sure it is maintained and working properly. Use the procedure in the Operation & Maintenance Manual for cleaning the spark arrester muffler (if equipped).

Welding And Grinding

Always clean the machine and attachment, disconnect the battery, and disconnect the wiring from the Bobcat controllers before welding. Cover rubber hoses, battery and all other flammable parts. Keep a fire extinguisher near the machine when welding.

Have good ventilation when grinding or welding painted parts. Wear dust mask when grinding painted parts. Toxic dust or gas can be produced.

Dust generated from repairing nonmetallic parts such as hoods, fenders or covers can be flammable or explosive. Repair such components in a well ventilated area away from open flames or sparks.

Fire Extinguishers

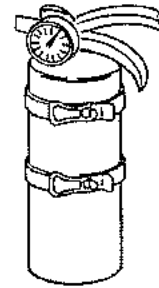

Know where fire extinguishers and first aid kits are located and how to use them. Inspect the fire extinguisher and service the fire extinguisher regularly. Obey the recommendations on the instructions plate.



Bobcat®

MACHINE SIGNS (DECALS) (CONT'D)

Follow the instructions on all the Machine Signs (Decals) that are on the loader. Replace any damaged machine signs and be sure they are in the correct locations. Machine signs are available from your Bobcat loader dealer.

Lift Kit Options



Single-Point Lift
Option - 6533898

WARNING
LIFTING CAPACITY
The lifting capacity of the loader is limited by the weight and distribution of the load. The operator must be trained in the proper use of the loader and must not exceed the rated lifting capacity. For more information, see the operator's manual.

Single-Point Lift
Option - 6565491 (2)

WARNING **AVERTISSEMENT**
LIFTING CAPACITY
The lifting capacity of the loader is limited by the weight and distribution of the load. The operator must be trained in the proper use of the loader and must not exceed the rated lifting capacity. For more information, see the operator's manual.

Single-Point Lift
Option - 6592879 (2)

FOR WINDOW REMOVAL
PULL UP AND OUT
Externally Removable Rear Window
- 6726393

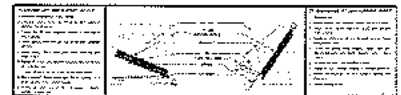

WARNING
HYPEREXTENSION AND IMPROPER LIFTING CAN CAUSE SERIOUS INJURY OR DEATH.
6577754

6711659

DANGER
AVOID DEATH!
Overloading or stacking up to 20 ft (6 m) high (10 ft (3 m) high for 1000 lb (450 kg) or less) can cause the loader to tip over. This can result in death or serious injury. Do not exceed the rated lifting capacity. For more information, see the operator's manual.

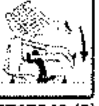

6717343 (2)
(Under Cab)

7170355 (3)
(Under Cab)

6595014

6698209
(Inside Fuse Cover)

FAN	FUEL PUMP	SWITCH POWER
22 AMP	15 AMP	15 AMP
18 AMP	15 AMP	15 AMP
18 AMP	15 AMP	15 AMP

6708929
DO NOT ADD FRESH COOLANT TO THE COOLANT SYSTEM PROTECTED TO 24 F (132 C) CENTER. ONLY ADD COOLANT TO THE COOLANT SYSTEM. Check Coolant With Refill/Service. See Operator's Manual for more information.

6566990
BOBCAT HYDROSTATIC FLUID

6560573
IMPORTANT
Check Coolant With Refill/Service. See Operator's Manual for more information.

6576048 (2)
WARNING
KEEP FINGERS AND OBJECTS AWAY FROM FAN

6804233
WARNING
Hot pressurized fluid. Can cause serious burns.

6734534
SERVICE CHECKLIST AND SCHEDULE
GENERAL LUBRICATION DIAGRAMS

PUBLICATIONS AND TRAINING RESOURCES

The following publications are also available for your Bobcat loader. You can order them from your Bobcat dealer.

For the latest information on Bobcat products and the Bobcat Company, visit our Web site at www.training.bobcat.com or www.bobcat.com.

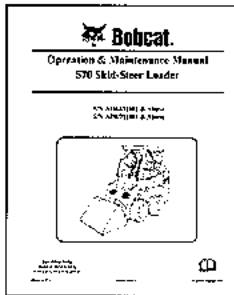

OPERATION & MAINTENANCE MANUAL

6986660enUS

Complete instructions on the correct operation and the routine maintenance of your Bobcat loader.

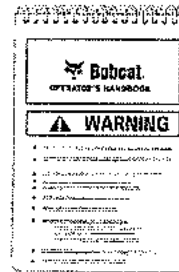

OPERATOR'S HANDBOOK

6986661

Gives basic operation instructions and safety warnings.



SAFETY MANUAL

6556500 (English and Spanish)

Gives basic safety procedures and warnings for your Bobcat loader.



OPERATOR SAFETY DVD

6904762 (English and Spanish)

DVD gives basic safety instructions for many Bobcat products including loaders.



SKID-STEER LOADER OPERATOR TRAINING COURSE

6901726 (English)

6902289 (Spanish)

Introduces operator to step-by-step basics of skid-steer loader operation.



SKID-STEER LOADER SERVICE SAFETY TRAINING COURSE

6900641

Introduces service technicians to step-by-step basics of proper and safe skid-steer loader maintenance and servicing procedures.

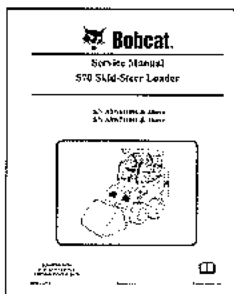

SERVICE MANUAL

6986662

Complete maintenance instructions for your Bobcat loader.



LOADER SAFETY VIDEO

(Mobile device with quick response code application required)

Scan the code above to watch the loader safety video or view at www.training.bobcat.com.

OPERATING INSTRUCTIONS

INSTRUMENT PANEL IDENTIFICATION	27
Left And Right Panels	27
Standard Key Panel	28
Keyless Start Panel	28
Option And Field Accessory Panel	29
Cab Heater Panel	29
CONTROL IDENTIFICATION	30
Standard Controls	30
SEAT BAR RESTRAINT SYSTEM	31
Operation	31
BOBCAT INTERLOCK CONTROL SYSTEM (BICS™)	32
Operation	32
LIFT ARM BYPASS CONTROL	33
Operation	33
PARKING BRAKE	33
Operation	33
TRACTION LOCK OVERRIDE	34
Operation	34
EMERGENCY EXIT	35
Rear Window	35
Front Door	35
BACK-UP ALARM SYSTEM	36
Description	36
Operation	36
ENGINE SPEED CONTROL	37
Operation	37
DRIVING AND STEERING THE LOADER	38
Operation	38
STOPPING THE LOADER	38
Using The Control Levers	38

HYDRAULIC CONTROLS	39
Description	39
Hydraulic Bucket Positioning	39
Auxiliary Hydraulic Control Lockout	39
Front Auxiliary Hydraulics Operation	40
Quick Couplers	41
Relieve Auxiliary Hydraulic Pressure (Loader And Attachment)	41
ATTACHMENT CONTROL DEVICE (ACD)	42
Description	42
DAILY INSPECTION	43
Daily Inspection And Maintenance	44
PRE-STARTING PROCEDURE	45
Entering The Loader	45
Operation & Maintenance Manual And Operator's Handbook Locations	45
Seat Adjustment	46
Seat Belt Adjustment	47
Seat Bar	47
STARTING THE ENGINE	48
Standard Key Panel	48
Keyless Start Panel	50
Cold Temperature Starting	52
Warming The Hydraulic / Hydrostatic System	52
MONITORING THE DISPLAY PANELS	52
Right Panel	52
STOPPING THE ENGINE AND LEAVING THE LOADER	53
Procedure	53
ATTACHMENTS	54
Choosing The Correct Bucket	54
Pallet Forks	54
Installing And Removing The Attachment	55
OPERATING PROCEDURE	58
Inspect The Work Area	58
Basic Operating Instructions	58
Driving On Public Roads	58
Operating With A Full Bucket	59
Operating With An Empty Bucket	59
Filling And Emptying The Bucket	60
Leveling The Ground Using Float	61
Digging And Filling A Hole	61
TOWING THE LOADER	62
Procedure	62

LIFTING THE LOADER63
 Single-Point Lift63

TRANSPORTING THE LOADER ON A TRAILER63
 Loading And Unloading63
 Fastening64



Bobcat®

INSTRUMENT PANEL IDENTIFICATION

Left And Right Panels

Figure 6

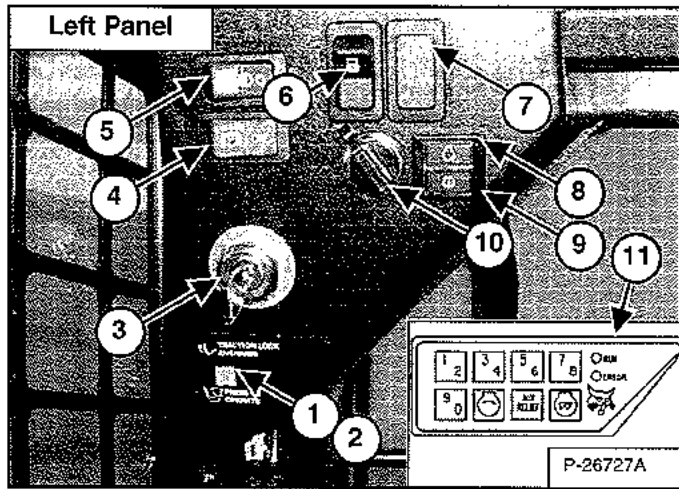
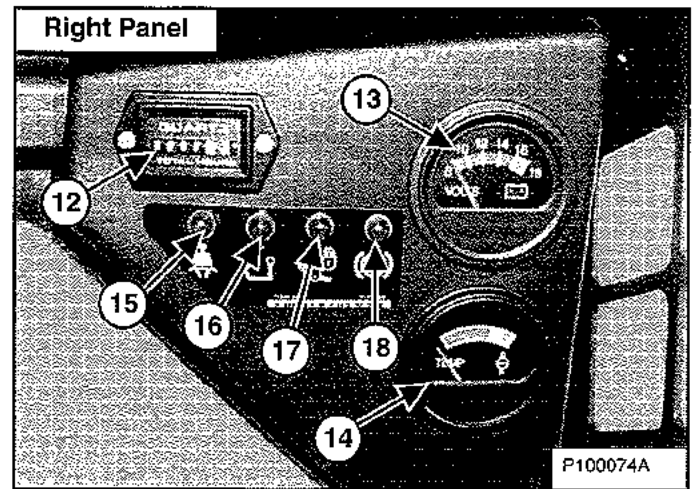

Figure 7



The table below shows the DESCRIPTION and FUNCTION / OPERATION for each of the instrument panel components.

REF.	DESCRIPTION	FUNCTION / OPERATION
1	TRACTION LOCK OVERRIDE BUTTON	<i>(Functions Only When The Seat Bar Is Raised, the Parking Brake Switch is OFF and the Engine Is Running.)</i> Allows you to use the steering levers to move the loader forward or backward when using the backhoe attachment. (See TRACTION LOCK OVERRIDE in this manual.) Engages auxiliary hydraulics.
2	PRESS TO OPERATE LOADER BUTTON	<i>(Functions Only When The Seat Bar Is Down.)</i> Activates BICS™ when the Seat Bar is down and operator is seated in the operating position. Engages auxiliary hydraulics.
3	KEY SWITCH	For starting and stopping the engine. (See Standard Key Panel in this manual.)
4	PARKING BRAKE	Press the left side of switch to engage; press right side to disengage.
5	LIGHT SWITCH	For FRONT work lights, "red" rear light, and REAR work light: Press the switch fully to the right to turn all lights OFF. Press the switch to the center position to turn on the FRONT work lights and "red" rear light. Press the switch fully to the left to turn on the FRONT work lights and REAR work light.
6	PREHEAT SWITCH	Press and hold to preheat the glow plugs to aid in cold temperature starting. (Earlier Models)
7	NOT USED	---
8	ENGINE WARNING LIGHT	Light is ON when engine oil pressure is low or coolant temperature is high. Stop the engine if the light comes ON.
9	TRANSMISSION WARNING LIGHT	Light is ON when transmission charge pressure is low, hydraulic filter needs replacement or fluid temperature is high. Stop the engine if the light comes ON.
10	POWER PLUG	Used to power 12 volt accessories.
11	KEYLESS PANEL	Optional Keyless Panel Kit. (See Keyless Start Panel in this manual.)
12	HOURLMETER	Records the total operating hours of the loader.
13	VOLTMETER	Shows the condition of the battery and the rate of charge.
14	ENGINE TEMPERATURE GAUGE	Shows the engine coolant temperature.
15	SEAT BELT INDICATOR LIGHT	Light stays on for 45 seconds to remind operator to fasten seat belt.
16	SEAT BAR LIGHT	Light is ON when the seat bar is raised.
17	LIFT & TILT VALVE LIGHT	Light is ON when the lift and tilt functions can NOT be operated. Light is OFF when the seat bar is down, the key switch is in the ON position and the PRESS TO OPERATE LOADER Button is pressed. The lift and tilt functions can be operated when the light is OFF.
18	PARKING BRAKE LIGHT	Light is ON when the Parking Brake is engaged.

INSTRUMENT PANEL IDENTIFICATION (CONT'D)

Standard Key Panel

Figure 8

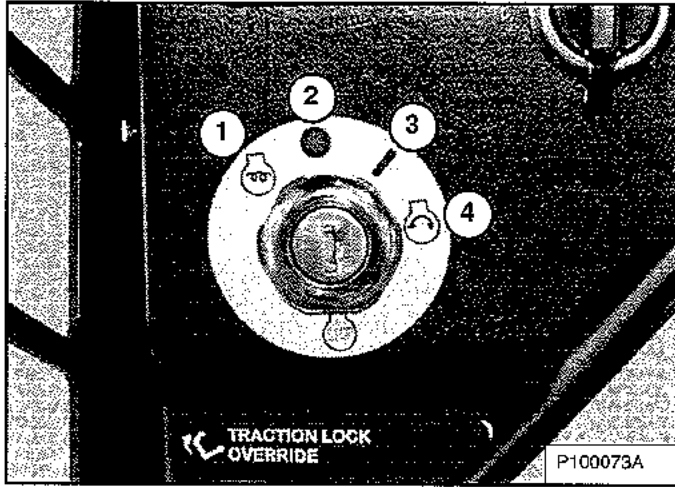

The functions of the Key Switch [Figure 8] are:

1. **ENGINE PREHEAT:** Hold the key in this position to activate the glow pugs. (Earlier model loaders have a separate preheat switch and do not have this position.) (See Left And Right Panels on Page 27.)
2. **STOP:** Stop the engine and turn the loader electrical system OFF.
3. **RUN:** Turn the loader electrical system ON.
4. **START:** Hold the key in this position to start the engine; release when engine starts.

Keyless Start Panel

Figure 9

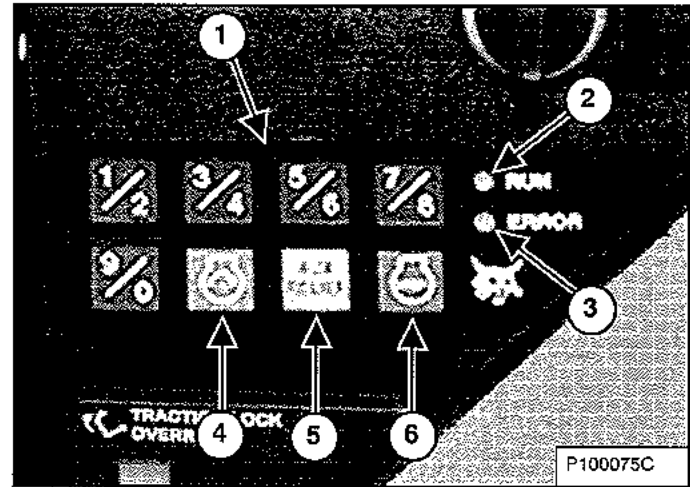

The functions of the Keyless Start Panel [Figure 9] are:

1. **KEYPAD (Keys 1 through 0):** Used to enter a number code (password) to allow starting the engine.
2. **RUN LIGHT:** Light will be ON after the password has been correctly entered.
3. **ERROR LIGHT:** Light will be ON when an incorrect user / master password is entered. Three consecutive incorrect passwords will cause an error condition and a delay of one minute will be required before another start sequence can be attempted.
4. **START Button:** Press the start button until the engine starts.
5. **AUX. RELIEF / PREHEAT Button:** Press and hold to activate the glow plugs after the password has been entered.
6. **STOP Button:** Used to stop the engine and shut down the loader electrical system.

NOTE: When a Keyless Start Panel Kit is installed, the kit will be supplied with an Owner Password. Change the password to one that you will easily remember to prevent unauthorized use of your loader. Keep your password in a safe place for future needs. (The Instructions included with the Keyless Start Panel will describe how to change the password. Keep this instruction for future reference.)

INSTRUMENT PANEL IDENTIFICATION (CONT'D)

Option And Field Accessory Panel

Figure 10

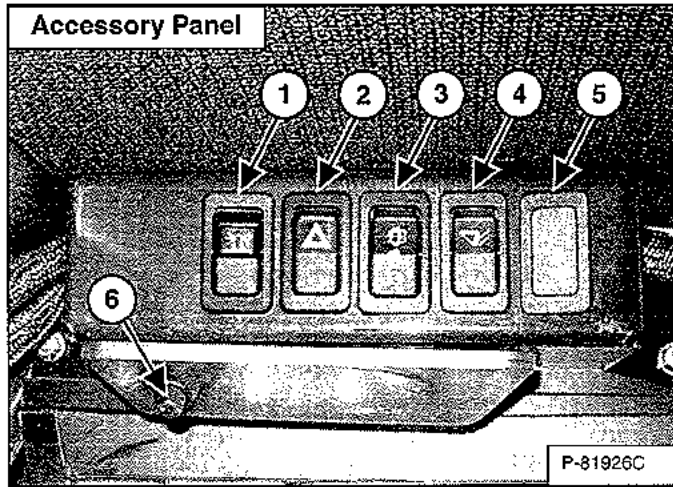

The side accessory panel is shown in [Figure 10].

REF. NO.	DESCRIPTION	FUNCTION / OPERATION
1	ROTATING BEACON (Option) OR STROBE LIGHT (Option)	Press the top of the switch to turn ON; press bottom to turn OFF.
2	HAZARD LIGHTS (Option)	Press the top of the switch to turn the Hazard Lights ON; press bottom to turn OFF.
3	FRONT WINDSHIELD WIPER (Option)	Move the switch to the center position to turn ON; press bottom to turn OFF. Press and hold the top of switch for washer fluid.
4	HYDRAULIC BUCKET POSITIONING (Option)	The Bucket Positioning function will keep the bucket in approximately the same position as the lift arms are raised. Press the top of the switch to engage the Bucket Position function; press the bottom to disengage.
5	NOT USED	---
6	CAB LIGHT (Option) (Earlier Models)	Press the switch to turn ON, press again to turn OFF.

Later Model Cab Light (If Equipped)

Figure 11

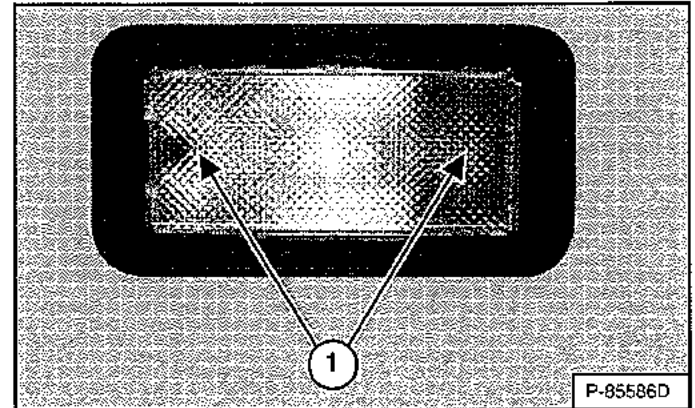

Push either side of the lens (Item 1) [Figure 11] to turn the light ON. Return the lens to the middle position to turn the light OFF.

Cab Heater Panel

This machine may be equipped with a Cab Heater.

Figure 12

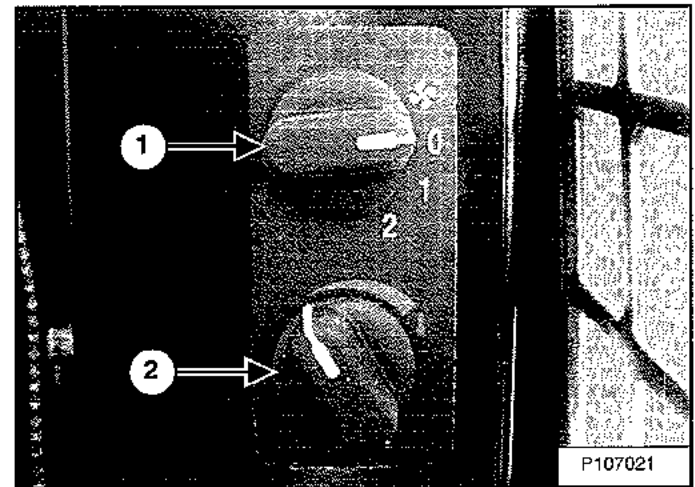

The cab heater panel is shown in [Figure 12].

REF. NO.	DESCRIPTION	FUNCTION / OPERATION
1	FAN MOTOR (Option)	Turn clockwise to increase fan speed; counterclockwise to decrease. There are three positions; OFF-1-2.
2	TEMPERATURE CONTROL (Option)	Turn clockwise to increase the temperature; counterclockwise to decrease.

CONTROL IDENTIFICATION

Standard Controls

Figure 13

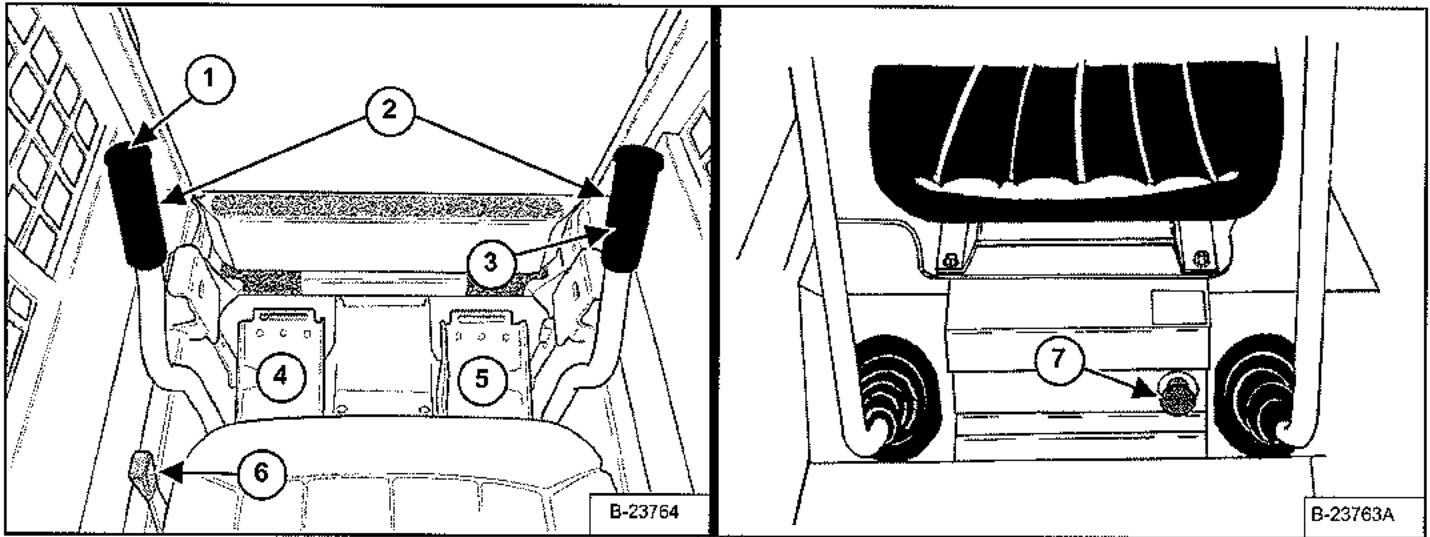

REF. NO.	DESCRIPTION	FUNCTION / OPERATION
* 1	FRONT HORN	Press the button to sound the front horn.
2	STEERING LEVERS	See DRIVING AND STEERING THE LOADER in this manual.
3	AUXILIARY HYDRAULICS CONTROL	See HYDRAULIC CONTROLS in this manual.
4	LIFT ARM PEDAL	See HYDRAULIC CONTROLS in this manual.
5	TILT PEDAL	See HYDRAULIC CONTROLS in this manual.
6	ENGINE SPEED CONTROL	See ENGINE SPEED CONTROL in this manual.
7	LIFT ARM BYPASS CONTROL	See LIFT ARM BYPASS CONTROL in this manual.

* Press the front switch to sound the front horn if equipped with deluxe hand grips.

SEAT BAR RESTRAINT SYSTEM

Operation

Figure 14

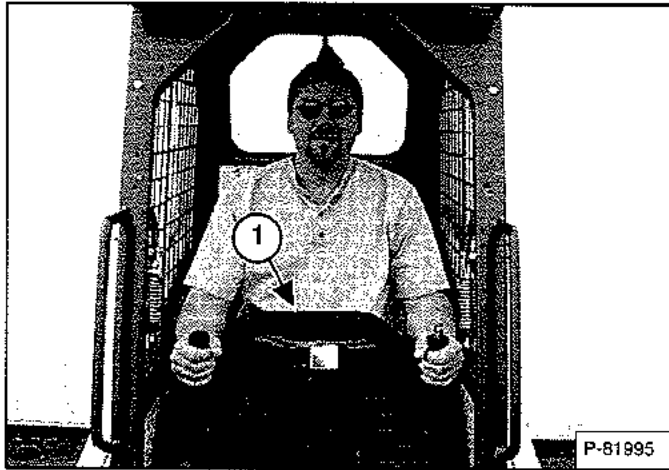

The seat bar restraint system has a pivoting seat bar with armrests (Item 1) [Figure 14].

WARNING

AVOID INJURY OR DEATH

When operating the machine:

- Keep the seat belt fastened snugly.
- The seat bar must be lowered.
- Keep your feet on the pedal controls and hands on steering levers.

W-2046-0108

The operator controls the use of the seat bar. The seat bar in the down position helps to keep the operator in the seat.

When the seat bar is down, the PRESS TO OPERATE LOADER button is activated, and the parking brake is released, the lift, tilt and traction drive functions can be operated.

When the seat bar is up, the lift, tilt and traction drive functions are deactivated. Both foot pedals will be locked when returned to the neutral position.

WARNING

Before you leave the operator's seat:

- Lower the lift arms, put the attachment flat on the ground.
- Stop the engine.
- Engage the parking brake.
- Raise the seat bar, move pedals until both lock.
- Move auxiliary hydraulic control lever out of detent position.

W-2164-0108

BOBCAT INTERLOCK CONTROL SYSTEM (BICS™)

Operation

! WARNING

AVOID INJURY OR DEATH

The Bobcat Interlock Control System (BICS™) must deactivate the lift, tilt and traction drive functions. If it does not, contact your dealer for service. **DO NOT** modify the system.

W-2151-1111

Figure 15



The Bobcat Interlock Control System (BICS™) has a pivoting seat bar with armrests (Item 1) [Figure 15]. The operator controls the use of the seat bar.

The BICS™ requires the operator to be seated in the operating position with the seat bar fully lowered before the lift, tilt, auxiliary hydraulics and traction functions can be operated. The seat belt must be fastened any time you operate the machine.

! WARNING

AVOID INJURY OR DEATH

When operating the machine:

- Keep the seat belt fastened snugly.
- The seat bar must be lowered.
- Keep your feet on the pedal controls and hands on steering levers.

W-2046-0108

Figure 16

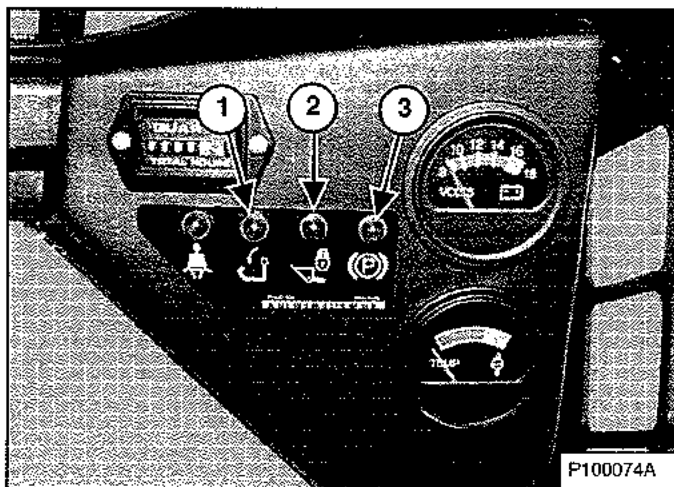

There are three display lights (Items 1, 2 and 3) [Figure 16] located on the right instrument panel that must be OFF to fully operate the machine.

When the seat bar is lowered, the engine is running, the PRESS TO OPERATE LOADER button is activated, and the parking brake is released, the lift, tilt, auxiliary hydraulics and traction drive functions can be operated.

When the seat bar is raised, the lift, tilt, auxiliary hydraulics and traction drive functions are deactivated.

! WARNING

Before you leave the operator's seat:

- Lower the lift arms, put the attachment flat on the ground.
- Stop the engine.
- Engage the parking brake.
- Raise the seat bar, move pedals until both lock.
- Move auxiliary hydraulic control lever out of detent position.

W-2164-0108

LIFT ARM BYPASS CONTROL

Operation

Figure 17

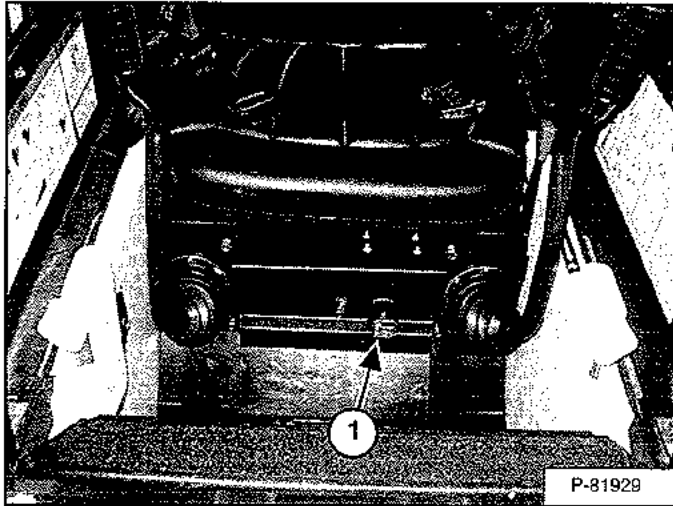

The lift arm bypass control (Item 1) [Figure 17] is used to lower the lift arms if the lift arms cannot be lowered during normal operations.

1. Sit in the operator seat.
2. Fasten the seat belt and lower the seat bar.
3. Turn the lift arm bypass knob (Item 1) [Figure 17] clockwise 1/4 turn.
4. Pull out and hold the knob until the lift arms lower.

PARKING BRAKE

Operation

Figure 18

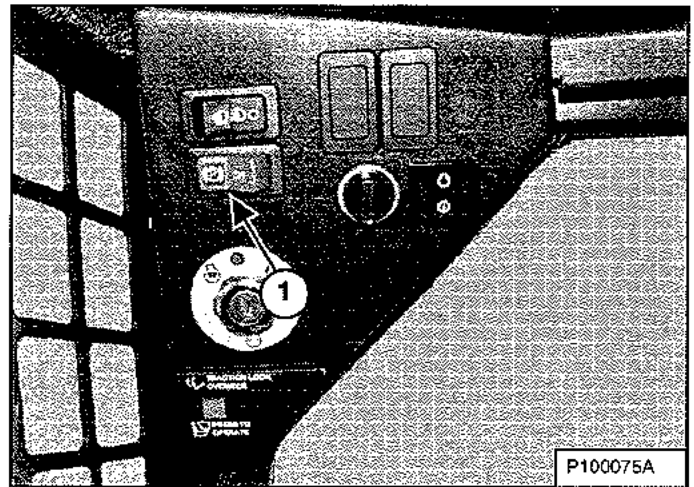

Press the left side of the switch (Item 1) [Figure 18] to engage the parking brake. The red light in the switch will turn on. The traction drive system will be locked.

Press the right side of the switch (Item 1) [Figure 18] to disengage the parking brake. The red light in the switch will turn off. The traction drive system will be unlocked.

NOTE: If the loader will not move when operator is in the operating position with the seat bar down and the parking brake disengaged and after the **PRESS TO OPERATE LOADER** button is pressed, move the steering levers either forward or backward a small amount to unlock the traction drive.

Figure 19

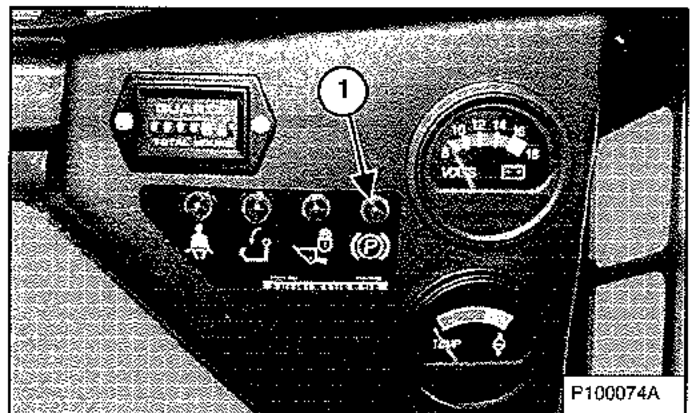

NOTE: The **PARKING BRAKE LIGHT** (Item 1) [Figure 19] on the right instrument panel will remain ON until the engine is started, the **PRESS TO OPERATE LOADER** button is pressed and the parking brake is disengaged.

TRACTION LOCK OVERRIDE

Operation

Figure 20

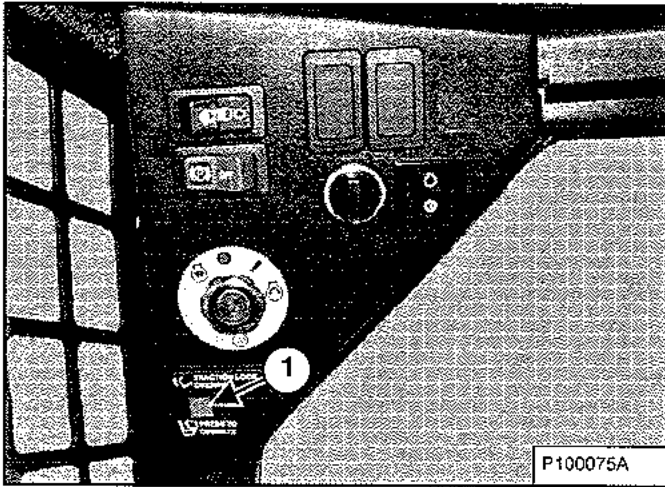
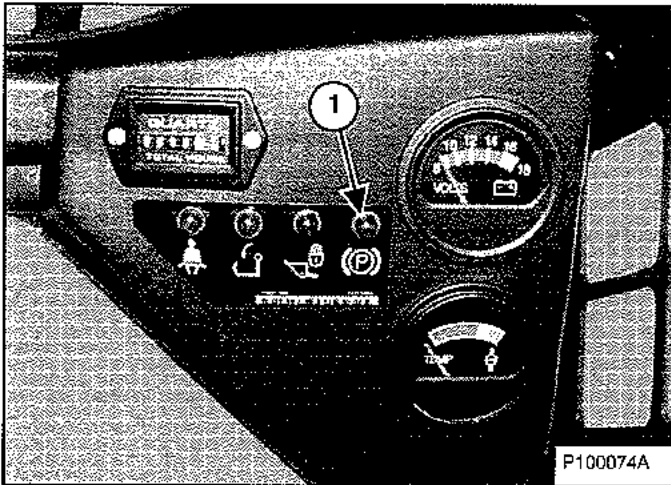

Figure 21



(Functions only when the seat bar is raised, the parking brake switch is OFF, and the engine is running.) There is a TRACTION LOCK OVERRIDE button (Item 1) [Figure 20] on the left instrument panel which will allow you to use the steering levers to move the loader forward and backward when using the backhoe attachment.

- Press the TRACTION LOCK OVERRIDE button once to unlock the brakes. The PARKING BRAKE light (Item 1) [Figure 21] will be OFF.
- Press the button a second time to lock the traction drive. The PARKING BRAKE light (Item 1) [Figure 21] will be ON.

EMERGENCY EXIT

The front opening on the operator cab and rear window provide exits.

Rear Window

Figure 22

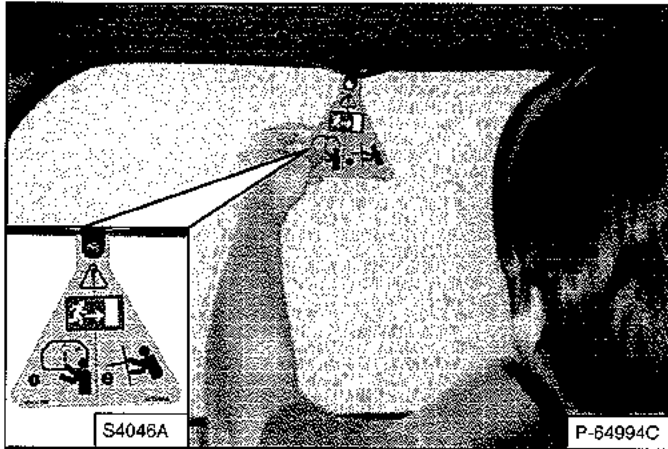

Pull the tag on the top of the rear window [Figure 22] to remove the rubber cord.

Push the rear window out of the rear of the operator cab.

Figure 23



Exit through the rear of the operator cab [Figure 23].

Front Door

This machine may be equipped with a Front Door.

NOTE: When an Operator Cab Enclosure Kit is installed, the window of the front door can be used as an emergency exit [Figure 24].

NOTE: If the loader has a Special Application Door Kit installed, the window of the front door is NOT an emergency exit.

Figure 24

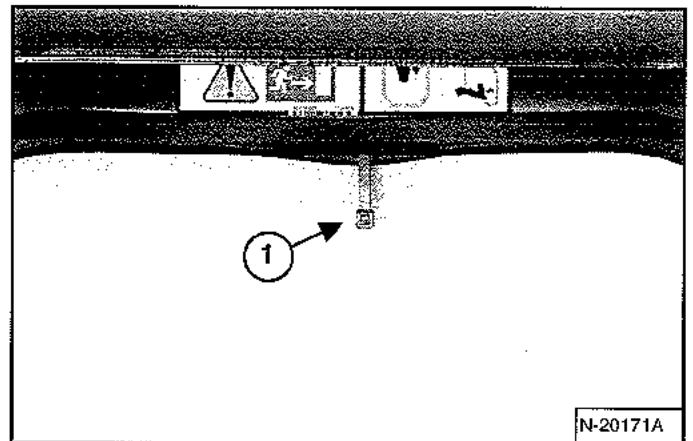

Pull the plastic loop (Item 1) [Figure 24] at the top of the window in the front door to remove the rubber cord.

Figure 25

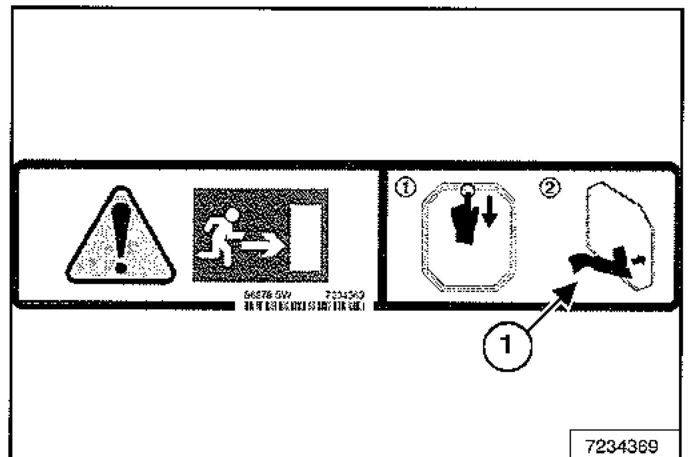

Push the window out with your foot at any corner of the window (Item 1) [Figure 25].

Exit through the front door.

BACK-UP ALARM SYSTEM

Description

Figure 26

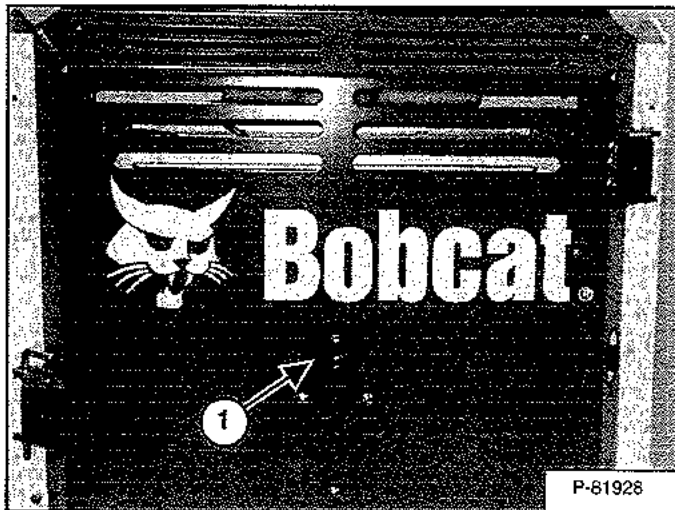

The back-up alarm (Item 1) [Figure 26] is located on the inside of the rear door.

A back-up alarm is not a substitute for looking to the rear when operating the loader in reverse, or for keeping bystanders away from the work area. Operators must always look in the direction of travel, including reverse, and must keep bystanders away from the work area, even though the loader is equipped with a back-up alarm.

Operators must be trained to **always** look in the direction of travel, **including when operating the loader in reverse** and to keep bystanders away from the work area. Other workers should be trained to **always** keep away from the operator's work area and travel path.

Operation

WARNING

AVOID INJURY OR DEATH

- **Always keep bystanders away from the work area and travel path.**
- **The operator must always look in the direction of travel.**
- **The back-up alarm must sound when operating the machine in the reverse direction.**

W-2783-0409

The back-up alarm will sound when the operator moves both steering levers into the reverse position. Slight movement of the steering levers into the reverse position is required with hydrostatic transmissions, before the back-up alarm will sound.

If alarm does not sound or for adjustment instructions, see inspection and maintenance instructions for the back-up alarm system in the preventive maintenance section of this manual. (See BACK-UP ALARM SYSTEM on Page 78.)

ENGINE SPEED CONTROL

Operation

Figure 27

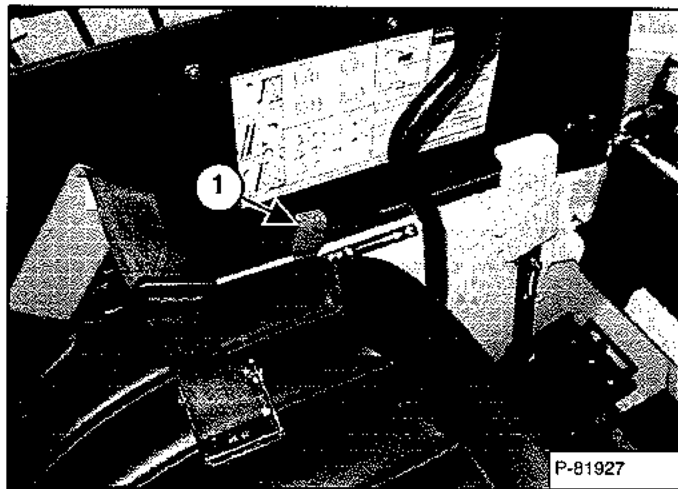

The engine speed control lever is to the left of the operator seat (Item 1) [Figure 27].

Move the lever forward to increase engine speed. Move backward to decrease engine speed.

DRIVING AND STEERING THE LOADER

Operation

Figure 28



The control levers (Item 1) [Figure 28] are on the left and right side in front of the seat.

Move the levers smoothly. Avoid sudden starting and stopping.

WARNING

AVOID INJURY OR DEATH

When operating the machine:

- Keep the seat belt fastened snugly.
- The seat bar must be lowered.
- Keep your feet on the pedal controls and hands on steering levers.

W-2046-0108

Figure 29

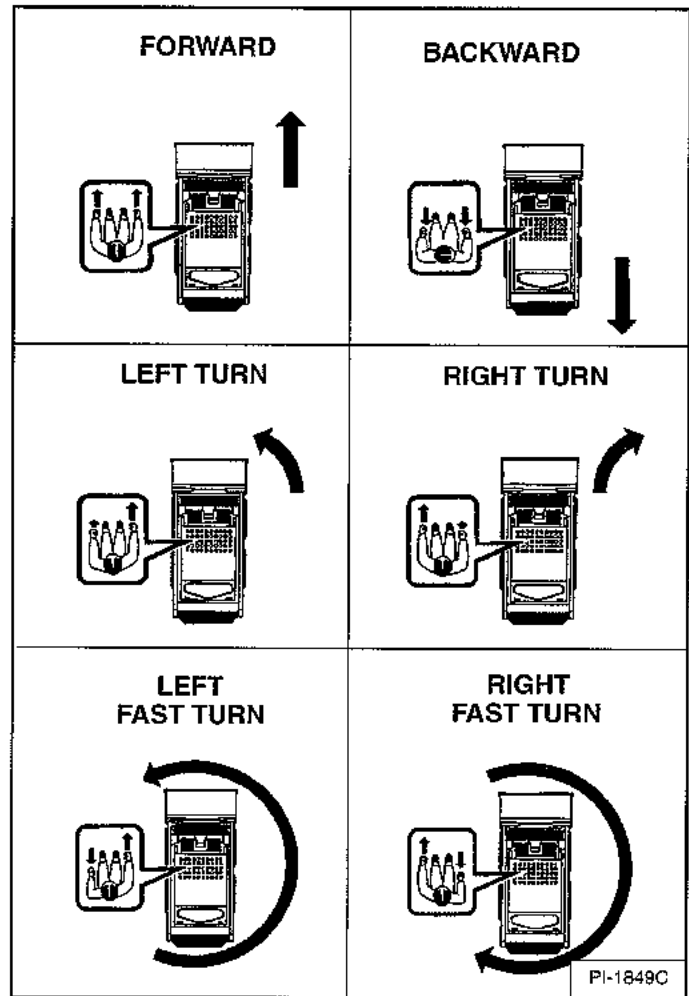

The levers control forward and backward travel and turning the loader [Figure 29].

Forward Travel - Push both levers forward.

Backward Travel - Pull both levers backward.

Normal Turning - Move one lever farther forward than the other.

Fast Turning - Push one lever forward and pull the other lever backward.

STOPPING THE LOADER

Using The Control Levers

When the steering levers are moved to the neutral position, the hydrostatic transmission will act as a *service brake* to stop the loader.

HYDRAULIC CONTROLS

Description

Two foot pedals control the hydraulic cylinders for the lift and tilt functions.

Put your feet on the pedals and **KEEP THEM THERE** any time you operate the loader.

Figure 30

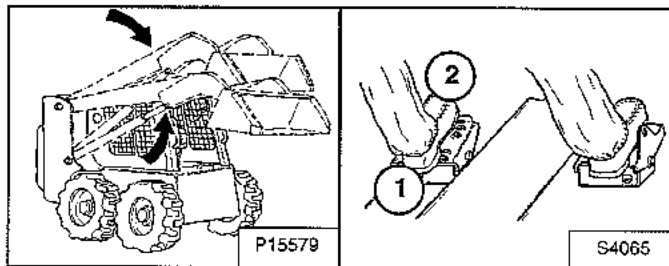

Lift Arm Operation (Left Pedal)

Push the heel (Item 1) [Figure 30] of the pedal to raise the lift arms.

Push the toe (Item 2) [Figure 30] of the pedal to lower the lift arms.

Lift Arm Float Position (Left Pedal)

Push the toe (Item 2) [Figure 30] of the pedal all the way forward until it locks into the float position.

Use the float position of the lift arms to level loose material while driving backward.

Raise the lift arms to disengage the float position.

Figure 31

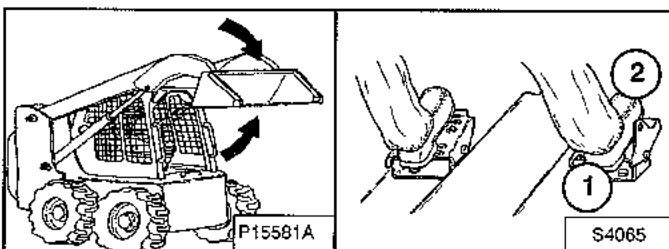

Tilt Operation - (Right Pedal)

Push the heel (Item 1) [Figure 31] of the pedal to tilt the bucket backward.

Push the toe (Item 2) [Figure 31] of the pedal to tilt the bucket forward.

Hydraulic Bucket Positioning

This machine may be equipped with Hydraulic Bucket Positioning.

The function of hydraulic bucket positioning is to keep the bucket in the same approximate position it is in before you begin raising the lift arms.

Figure 32

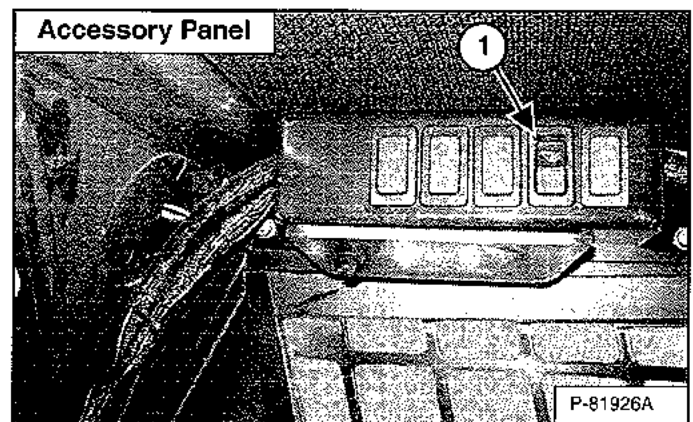

Press the top of the BUCKET POSITIONING switch (Item 1) [Figure 32] to engage the bucket positioning function. Press the bottom of the switch to disengage this function.

Bucket positioning functions only during upward lift cycle.

Auxiliary Hydraulic Control Lockout

Figure 33

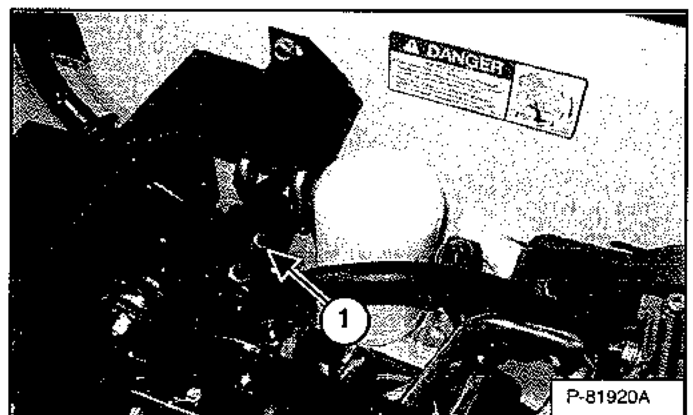

Raise the operator cab. (See OPERATOR CAB on Page 80.)

Remove the auxiliary hydraulic control lockout bolt and nut (Item 1) [Figure 33] before using the auxiliary control for the first time.

Lower the operator cab. (See OPERATOR CAB on Page 80.)

HYDRAULIC CONTROLS (CONT'D)

Front Auxiliary Hydraulics Operation

Variable Flow

Figure 34

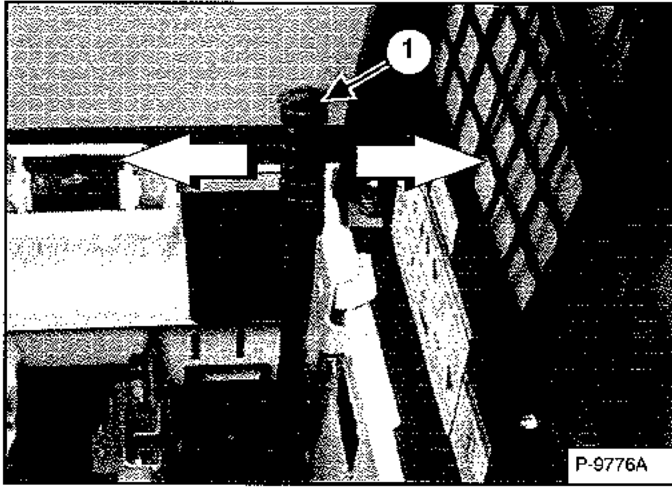

Variable Flow allows for slow-to-fast movement of auxiliary hydraulic functions.

The right steering lever (Item 1) [Figure 34] is also the control lever for the front auxiliary hydraulics (Auxiliary Hydraulic Control Lever).

Enter the loader, lower the seat bar, fasten seat belt, engage the parking brake and start the engine. Press the PRESS TO OPERATE LOADER button which will also engage the auxiliary hydraulics.

Figure 35

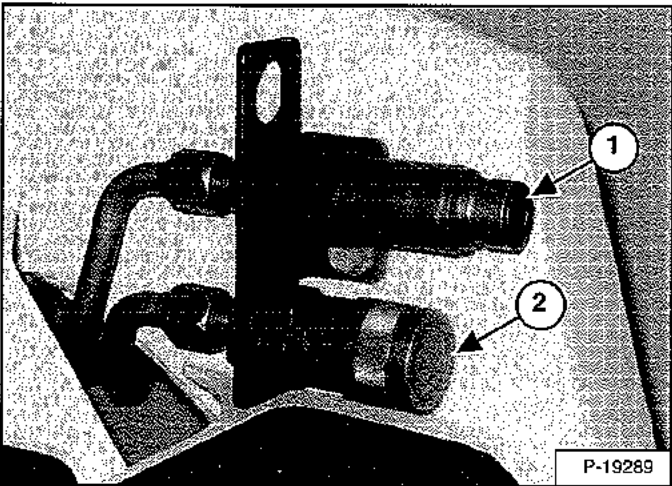

Move the Auxiliary Hydraulic Control Lever (Item 1) [Figure 34] to the left for auxiliary hydraulic oil flow to the front male coupler (Item 1) [Figure 35]. Hydraulic oil flow increases to the coupler as the lever is moved to the left.

Move the Auxiliary Hydraulic Control Lever (Item 1) [Figure 34] to the right for auxiliary hydraulic oil flow to the front female coupler (Item 2) [Figure 35]. Hydraulic oil flow increases to the coupler as the lever is moved to the right.

Continuous Flow

Continuous Flow allows for fast movement of auxiliary hydraulic functions.

Move the Auxiliary Hydraulic Control Lever fully to the right to put it into continuous flow (detent) position. This will allow continuous auxiliary hydraulic oil flow to the female coupler. Move the lever to the neutral position to stop auxiliary hydraulic oil flow

Move the lever out of the continuous flow (detent) position before leaving the operator's seat.

NOTE: When the operator is seated and raises the seat bar, the Auxiliary Hydraulic System will deactivate.

HYDRAULIC CONTROLS (CONT'D)

Quick Couplers

! WARNING

AVOID BURNS

Hydraulic fluid, tubes, fittings and quick couplers can get hot when running machine and attachments. Be careful when connecting and disconnecting quick couplers.

W-2220-0396

! WARNING

AVOID INJURY OR DEATH

Diesel fuel or hydraulic fluid under pressure can penetrate skin or eyes, causing serious injury or death. Fluid leaks under pressure may not be visible. Use a piece of cardboard or wood to find leaks. Do not use your bare hand. Wear safety goggles. If fluid enters skin or eyes, get immediate medical attention from a physician familiar with this injury.

W-2072-0807

Figure 36

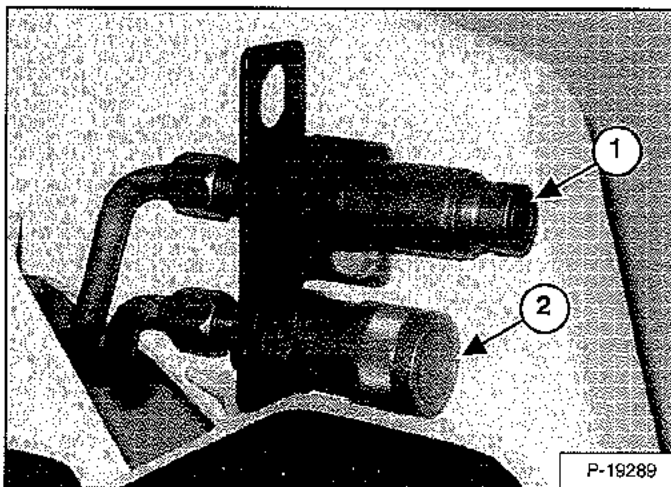

To Connect: Remove dirt or debris from the surface of both the male (Item 1) and female couplers (Item 2) [Figure 36], and from the outside diameter of the male coupler. Visually check the couplers for corroding, cracking, damage or excessive wear. If any of these conditions exist, the coupler(s) must be replaced.

Install the male coupler into the female coupler. Full connection is made when the ball release sleeve slides forward on the female coupler.

To Disconnect: Hold the male coupler. Retract the sleeve on the female coupler until the couplers disconnect.

Relieve Auxiliary Hydraulic Pressure (Loader And Attachment)

Hydraulic pressure in the auxiliary hydraulic system can make it difficult to engage quick couplers to an attachment.

Loader:

1. Turn the key to the ON position or press RUN button but do not start the engine. Press the PRESS TO OPERATE LOADER Button.

Figure 37

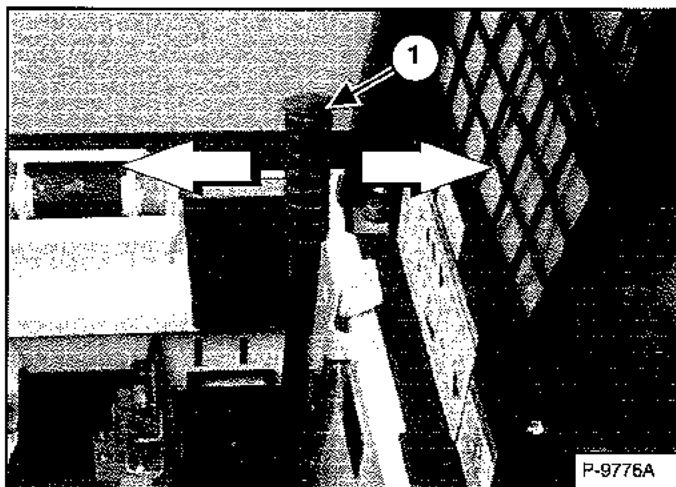

2. Move the Auxiliary Hydraulic Control Lever (Item 1) [Figure 37] left and right to release auxiliary hydraulic oil pressure. Turn key to OFF position or press STOP button.

Attachments:

1. Follow procedure above to release pressure in the loader.
2. Connect male coupler from attachment to female coupler of the loader then repeat procedure above. This will release pressure in the attachment.
3. Connect the female coupler from the attachment to the male coupler of the loader.

ATTACHMENT CONTROL DEVICE (ACD)

This machine may be equipped with an Attachment Control Device.

Description

Figure 38

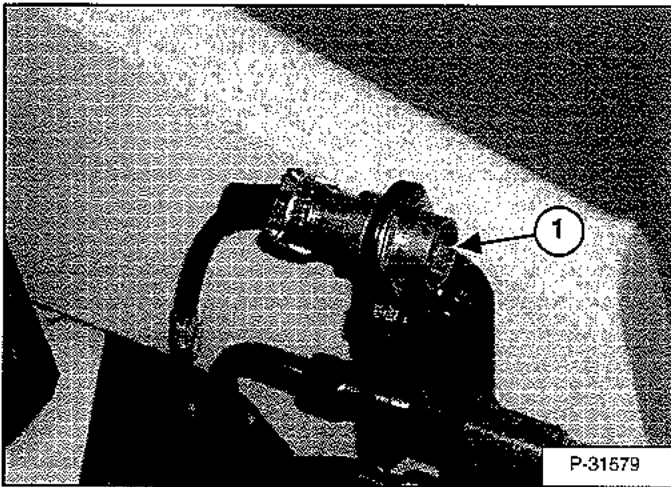

Connect the attachment electrical harness to the attachment control device (Item 1) [Figure 38].

Figure 39

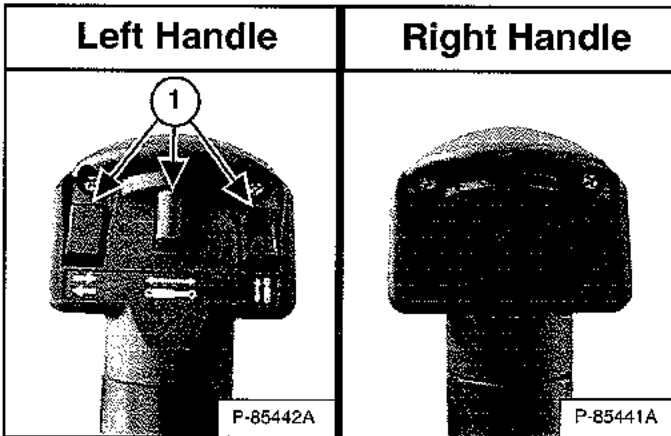

Additional switches (Item 1) [Figure 39] on the left steering lever handle are used to control some attachment functions through the attachment control device.

See the appropriate attachment Operation & Maintenance Manual for control details.

Figure 40

GENERAL LUBRICATION DIAGRAMS

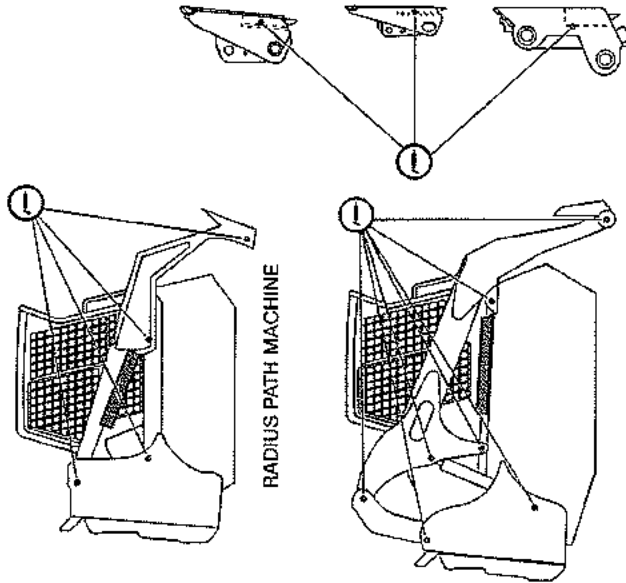

○ TYPICAL GREASE POINTS

SERVICE CHECKLIST AND SCHEDULE

- EVERY 10 HRS (BEFORE STARTING THE LOADER)**
- **ENGINE OIL & FILTER** - Check level and add as needed. Do not overfill. Change oil and filter after first 50 Hrs. then refer to Operation & Maintenance Manual for proper change interval for your Model.
 - **ENGINE AIR FILTER** - Check condition indicator and/or display. Service only when required. Do not use compressed air to clean elements.
 - **ENGINE AIR SYSTEM** - Check for leaks and damaged components.
 - **ENGINE COOLING SYSTEM** - Clean debris from grill, oil cooler and radiator. Check coolant level cold; add coolant mixture if required.
 - **FUEL FILTER** - Remove trapped water.
 - **LOADER LIFT ARMS, LIFT LINKS, CYLINDERS, BOB-TACH PIVOT & WEDGES, STEERING CYLINDERS (AWS Machines Only)** - Lubricate with multipurpose lithium based grease.
 - **SEAT BELT SEAT BAR AND CONTROL INTERLOCKS** - Check function. Repair or replace as needed. Clean dirt and debris from moving parts.
 - **BICS** - Check for correct function. Clean dirt and debris from moving parts. Lift and Tilt functions MUST NOT operate with seat bar raised.
 - **TIRES** - Check air pressure. Inflate to MAXIMUM pressure shown on sidewall of tire.
 - **GENERAL** - Check for loose or broken parts, damaged operator cab, instrument operation, loose wheel nuts or track sprocket nuts, oil leaks, damaged or missing safety signs (decals).
- EVERY 50 HRS**
- **HYDRAULIC FLUID, HOSES AND TUBELINES** - Check fluid level and add if required. Check for damage and for leaks. Repair or replace as needed.
 - **FINAL DRIVE TRANSMISSION (CHANGECASE, Wheel Machines Only)** - Check fluid level and add if required. Adjust as needed.
 - **HYDRAULIC STEERING CONTROLS (PEDALS, HAND, and/or JOYSTICK)** - Check for correct operation.
 - **WHEEL NUTS / TRACK DRIVE SPROCKETS** - Check for loose nuts and tighten as needed.
 - **TRACK TENSION (Track Machines Only)** - Check tension and adjust as needed.
- EVERY 100 HRS**
- **SPARK ARRESTOR MUFFLER** - Empty spark chamber, if equipped.
 - **BATTERY** - Check battery for damage, load down clamps, cables, connections and electrolyte level. Add distilled water as needed.
 - **DRIVE LINE** - Lubricate Engine-to-Pump Coupler with multipurpose lithium based grease. (If equipped)
- EVERY 250 HRS**
- **STEERING LEVER PIVOTS** - Lubricate with multipurpose lithium based grease. (If equipped.)
 - **FUEL FILTER** - Replace filter.
 - **KING PINS (AWS Machines Only)** - Lubricate with multipurpose lithium based grease.
 - **ENGINE / HYDRAULIC DRIVE BELT** - Check for wear or damage. Adjust or replace as needed. (If equipped.)
 - **FAN DRIVE GEARBOX** - Check fluid level and add if required. (If equipped)
 - **OTHER DRIVE BELTS (Hydrostatic pump, water pump, alternator, and air conditioner - if equipped)** - Check condition and tension. Adjust or replace as needed.
 - **BICS** - Check function of Lift Arm By-Pass control.
- EVERY 500 HRS**
- **FAN / HYDRAULIC / HYDROSTATIC SYSTEM** - Replace filter. Replace reservoir breather cap.
 - **STEERING VALVE INLINE FILTER (AWS Only)** - Replace filter.
 - **HYDROSTATIC MOTOR CARRIER (Track Machines Only)** - Replace oil.
- EVERY 1000 HRS**
- **HYDRAULIC RESERVOIR** - Replace fluid.
 - **FINAL DRIVE TRANSMISSION (Changecase on Wheel Machines Only)** - Replace fluid.
 - **TRACK ROLLER, IDLER ASSEMBLIES (Track Machines Only)** - Replace fluid (if required).
 - **DRIVE MOTOR CASE DRAIN FILTER** - Replace filter (if equipped).
 - **WHEEL BEARING & OUTER SPLINES (AWS only)** - Repack wheel bearings, grease internal splines in hub yoke. (Dealer Service Only)

NOTES:

- Replace element sooner if transmission warning indicator remains on for more than 5 minutes after hydraulic fluid is at operating temperature.
- See Operation & Maintenance Manual for correct fluid specifications, filter part number and location, and appropriate service intervals for your Model.

SEE OPERATION & MAINTENANCE MANUAL FOR MORE INFORMATION AND INSTRUCTIONS.

WARNING

- AVOID INJURY OR DEATH**
- Keep door closed except for service.
 - Keep engine clean of flammable material.
 - Keep body, loose objects and clothing away from electrical contacts, moving parts, hot parts and exhaust.
 - Do not use loader in space with explosive dusts or gases or with flammable material near exhaust.
 - Never use ether or starting fluid on diesel engine with glow plugs. Use only starting aids as approved by engine manufacturer.
 - Leaking fluids under pressure can enter skin and cause serious injury.
 - Battery acid causes severe burns; wear goggles. If acid contacts eyes, skin, or clothing, flush with water. For contact with eyes, flush and get medical attention.
 - Battery makes flammable and explosive gas. Keep arcs, sparks, flames and lighted tobacco away.
 - For jump start, connect negative cable to loader engine last (never at the battery). After jump start, remove negative connection at the engine first.
 - Exhaust gases can kill. Always ventilate.



73004 SVY
6734534 ENLUS
© 2010 BOBCAT

DAILY INSPECTION (CONT'D)

Daily Inspection And Maintenance

Maintenance work must be done at regular intervals. Failure to do so will result in excessive wear and early failures. The Service Schedule [Figure 40] is a guide for correct maintenance of the Bobcat Loader. It is located inside the rear door of the loader and also in the MACHINE SIGN TRANSLATION section of this manual. (See Service Schedule (6734534) on Page 117.)

- Engine oil level.
- Hydraulic / hydrostatic fluid level.
- Engine Air Filter - Check Air System for Damage or Leaks.
- Engine coolant system - check system for damage or leaks.
- Operator cab and cab mounting hardware.
- Seat belt.
- Seat Bar and Control interlocks.
- Bobcat Interlock Control System (BICS™).
- Front Horn and Back-up Alarm - Check for proper function.
- Grease Pivot Pins (Lift Arms, Bob-Tach, Cylinders, Bob-Tach Wedges).
- Tires - Check for Wear, Damage, Correct Air Pressure.
- Fuel Filter - Remove Trapped Water.
- Loose or Broken Parts - Repair or Replace as Necessary.
- Safety Treads and Safety Signs (Decals) - Replace as necessary.
- Lift Arm Support Device - Replace if damaged.
- Indicators and Lights.
- Clean Foot Pedal Area.
- Monitor Instrument Panel for fuel level, coolant temperature and air cleaner condition.



WARNING

Operator must have instructions before operating the machine. Untrained operators can cause injury or death.

W-2001-0502

NOTE: Fluids such as engine oil, hydraulic fluid, coolant, etc. must be disposed of in an environmentally safe manner. Some regulations require that certain spills and leaks on the ground must be cleaned in a specific manner. See local, state and federal regulations for correct disposal.

IMPORTANT

PRESSURE WASHING DECALS

- Never direct the stream at a low angle toward the decal that could damage the decal causing it to peel from the surface.
- Direct the stream at a 90 degree angle and at least 300 mm (12 in) from the decal. Wash from the center of the decal toward the edges.

I-2226-0910

PRE-STARTING PROCEDURE

Entering The Loader

Figure 41



Use the bucket or attachment steps, grab handles, and safety treads (on the loader lift arms and frame) to get on and off the loader, maintaining a 3-point contact at all times [Figure 41]. **DO NOT JUMP!**

Safety treads are installed on the Bobcat Loader to provide a slip resistant surface for getting on and off the loader.

Keep the safety treads clean and replace them when damaged. Replacement treads are available from your Bobcat dealer.

Operation & Maintenance Manual And Operator's Handbook Locations

Figure 42

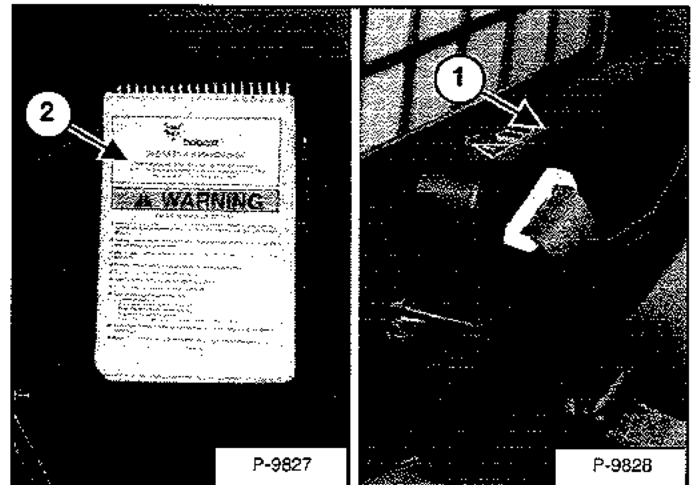

Read and understand the Operation & Maintenance Manual (Item 1) and the Operator's Handbook (Item 2) [Figure 42] before operating the loader.

The Operation & Maintenance Manual and other manuals can be kept in a container (Item 1) [Figure 42] provided on the right side of the operator seat.



AVOID INJURY OR DEATH

Instructions are necessary before operating or servicing machine. Read and understand the Operation & Maintenance Manual, Operator's Handbook and signs (decals) on machine. Follow warnings and instructions in the manuals when making repairs, adjustments or servicing. Check for correct function after adjustments, repairs or service. Untrained operators and failure to follow instructions can cause injury or death.

W-2003-0807

PRE-STARTING PROCEDURE (CONT'D)

Seat Adjustment

Standard Seat

Figure 43

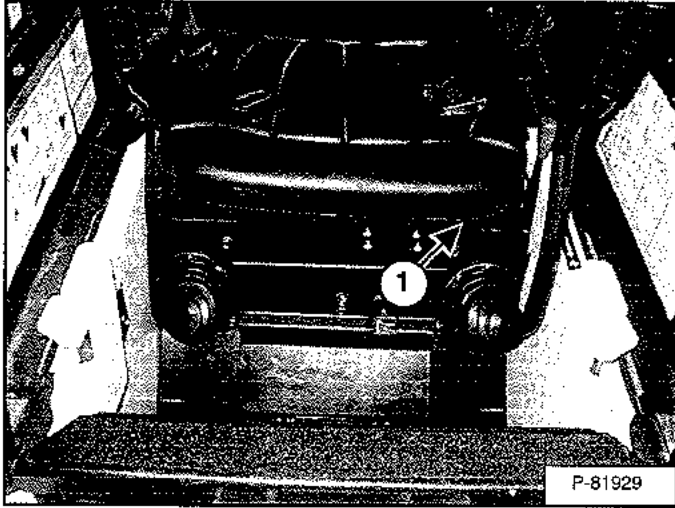

Use the lever (Item 1) [Figure 43] to adjust the position of the seat for comfortable operation of the loader controls.

Adjustable Cushion Seat

Figure 44

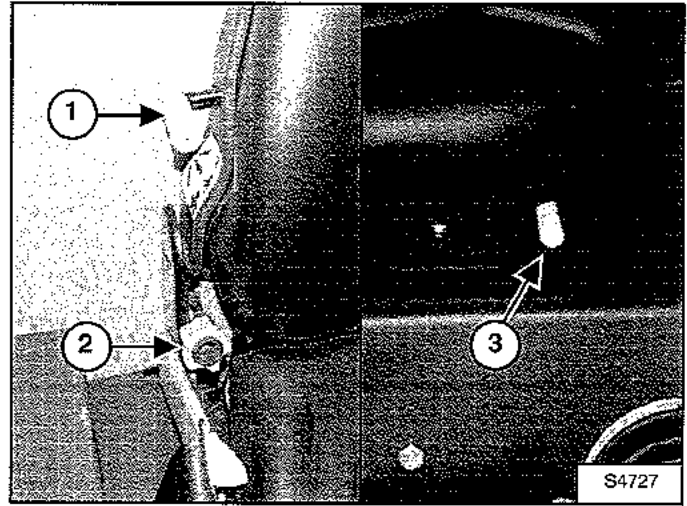

Use the lever (Item 1) and knob (Item 2) [Figure 44] to adjust the position of the seat for comfortable operation of the loader controls.

The lever (Item 1) sets the seat cushion for the weight of the operator. The knob (Item 2) [Figure 44] sets the angle of the seat back.

The lever (Item 3) [Figure 44] adjusts the fore / aft position of the seat.

PRE-STARTING PROCEDURE (CONT'D)

Seat Belt Adjustment

! WARNING

AVOID INJURY OR DEATH

When operating the machine:

- Keep the seat belt fastened snugly.
- The seat bar must be lowered.
- Keep your feet on the pedal controls and hands on steering levers.

W-2046-0108

Figure 45

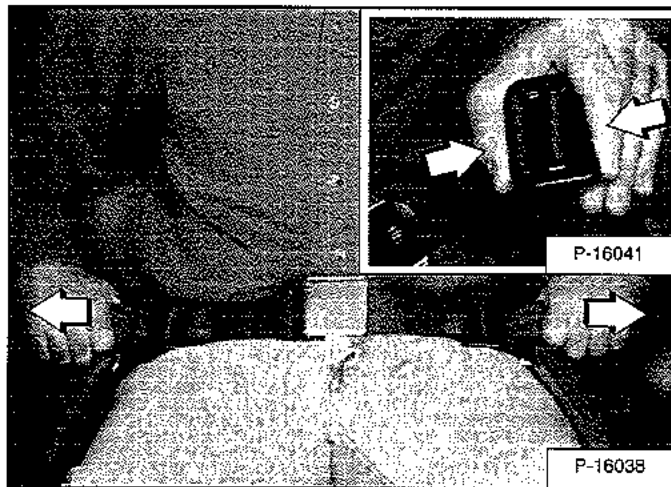

Squeeze both seat belt adjusters to release and lengthen each half of the seat belt [Figure 45].

Fasten the seat belt.

Pull the ends of the belt through the belt adjusters so that the seat belt is snug and the buckle is centered between your hips [Figure 45].

Seat Bar

Figure 46

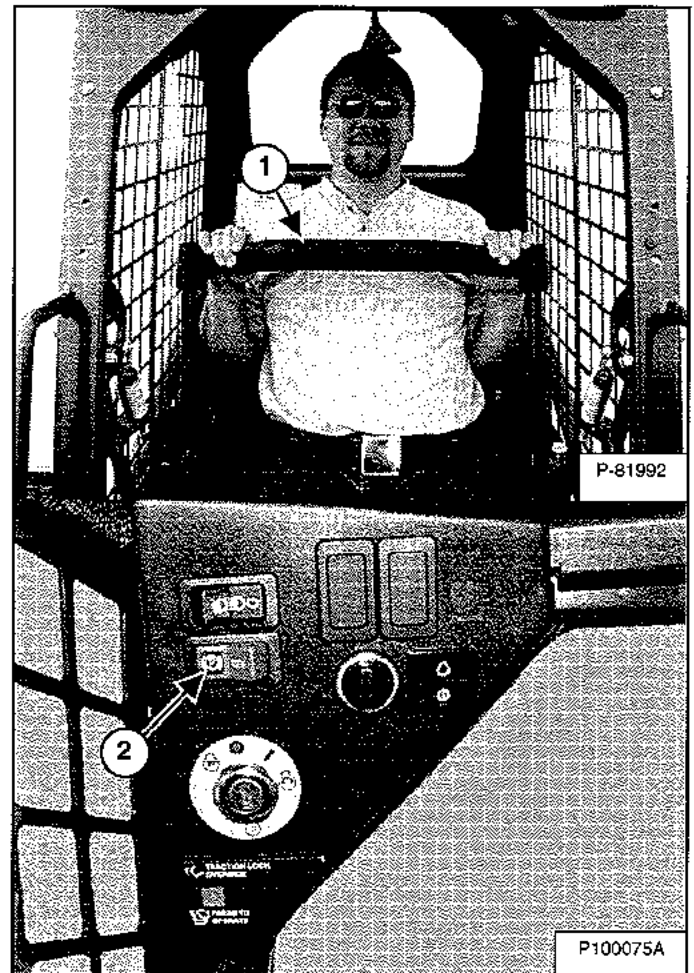

Lower the seat bar (Item 1) and engage the parking brake (Item 2) [Figure 46].

Put the foot pedals and steering levers in neutral position.

NOTE: Keep your hands on the steering levers and your feet on the foot pedals while operating the loader.

! WARNING

AVOID INJURY OR DEATH

When operating the machine:

- Keep the seat belt fastened snugly.
- The seat bar must be lowered.
- Keep your feet on the pedal controls and hands on steering levers.

W-2046-0108

STARTING THE ENGINE

Standard Key Panel

! WARNING

AVOID SERIOUS INJURY OR DEATH

- Engines can have hot parts and hot exhaust gas. Keep flammable material away.
- Do not use machines in atmosphere containing explosive dust or gases.

W-2051-0212

Perform the PRE-STARTING PROCEDURE. (See PRE-STARTING PROCEDURE on Page 45.)

Figure 47

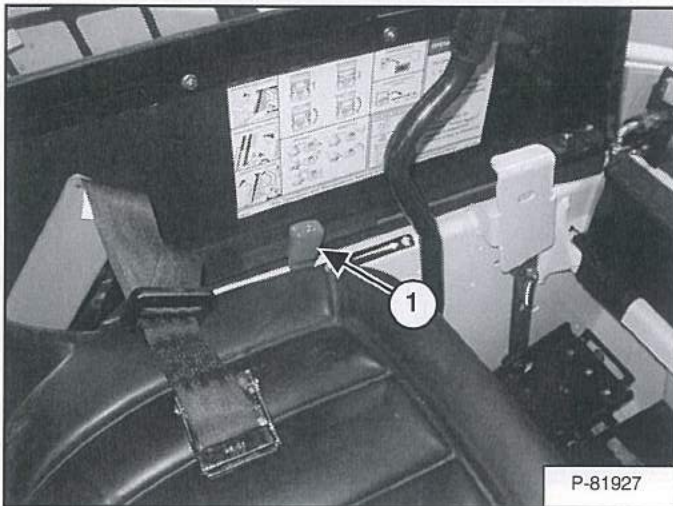

Move the engine speed control lever (Item 1) [Figure 47] to the mid position.

! WARNING

AVOID INJURY OR DEATH

- Fasten seat belt, start and operate only from the operator's seat.
- Never wear loose clothing when working near machine.

W-2135-1108

Figure 48

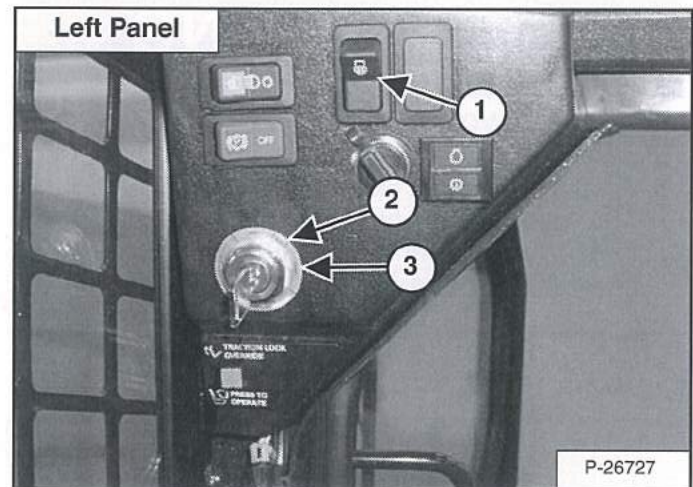

Earlier Models With Preheat Switch (Item 1)

If the temperature is cold, turn the key switch to the RUN position (Item 2) [Figure 48] but do not start the engine.

Press and hold the top of the preheat switch (Item 1) [Figure 48]. Release the switch to stop engine preheat. A decal in the operator cab and the table below show suggested preheat times.

AMBIENT AIR TEMPERATURE	PREHEAT TIME
21°C and Above (70°F and Above)	None Required
10 - 21°C (50 - 70°F)	5 Seconds
-18 - 10°C (0 - 50°F)	15 Seconds
-18°C and Below (0°F and Below)	25 Seconds

NOTE: You can hold the preheat switch for up to 25 seconds at a time while cranking.

Turn the key switch to the START position (Item 3) [Figure 48] and continue to crank for up to one minute or until the engine starts.

Release the key when the engine starts. It will return to the RUN position (Item 2) [Figure 48].

STARTING THE ENGINE (CONT'D)

Standard Key Panel (Cont'd)

Figure 49

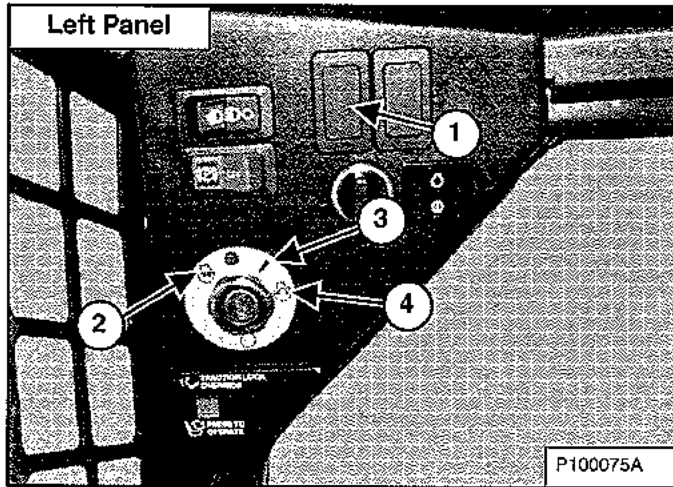

Later Models Without Preheat Switch (Item 1)

If the temperature is cold, turn the key switch to the PREHEAT position (Item 2) [Figure 49].

Release the key switch to stop engine preheat. A decal in the operator cab and the table below show suggested preheat times.

AMBIENT AIR TEMPERATURE	PREHEAT TIME
21°C and Above (70°F and Above)	None Required
10 - 21°C (50 - 70°F)	5 Seconds
-18 - 10°C (0 - 50°F)	15 Seconds
-18°C and Below (0°F and Below)	25 Seconds

Turn the key switch to the START position (Item 4) [Figure 49] and continue to crank for up to one minute or until the engine starts.

Release the key when the engine starts. It will return to the RUN position (Item 3) [Figure 49].

All Models

Figure 50

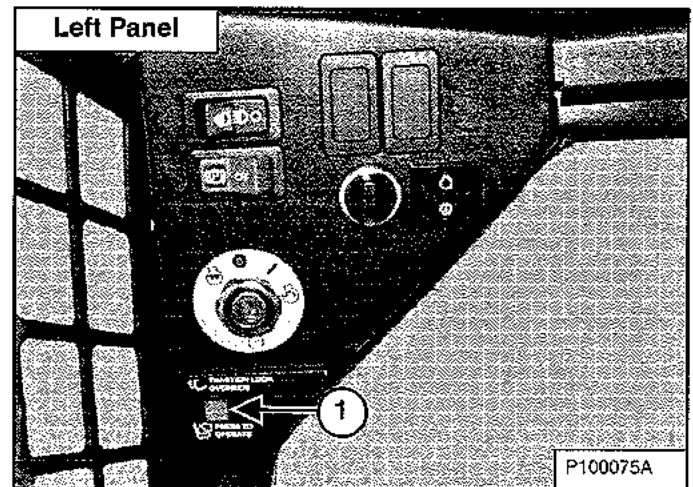
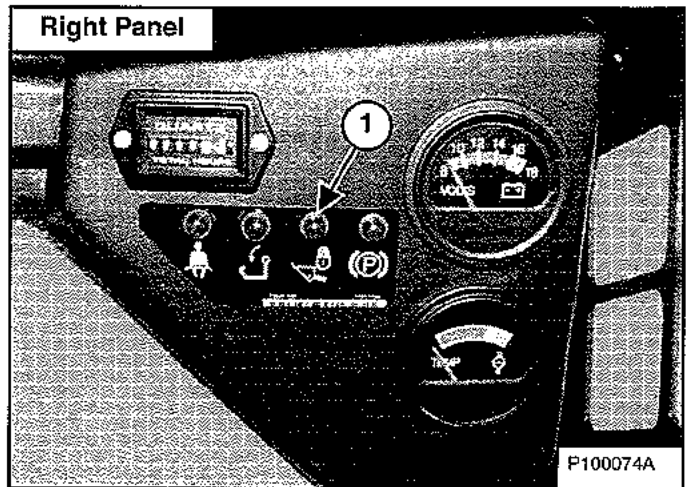

Figure 51



Press the PRESS TO OPERATE LOADER button (Item 1) [Figure 50] to activate the BICS™ and to perform hydraulic and loader functions. The Lift & Tilt Valve light (Item 1) [Figure 51] will be OFF when the BICS™ is active.

WARNING

AVOID INJURY OR DEATH

When an engine is running in an enclosed area, fresh air must be added to avoid concentration of exhaust fumes. If the engine is stationary, vent the exhaust outside. Exhaust fumes contain odorless, invisible gases which can kill without warning.

W-2050-0807

STARTING THE ENGINE (CONT'D)

Keyless Start Panel

! WARNING

AVOID SERIOUS INJURY OR DEATH

- Engines can have hot parts and hot exhaust gas. Keep flammable material away.
- Do not use machines in atmosphere containing explosive dust or gases.

W-2051-0212

Perform the PRE-STARTING PROCEDURE. (See PRE-STARTING PROCEDURE on Page 45.)

Figure 52

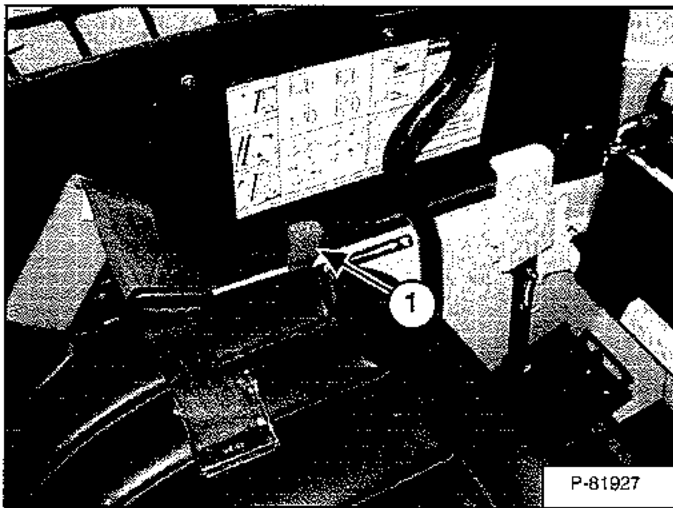

Move the engine speed control lever (Item 1) [Figure 52] to the mid position.

! WARNING

AVOID INJURY OR DEATH

- Fasten seat belt, start and operate only from the operator's seat.
- Never wear loose clothing when working near machine.

W-2135-1108

Figure 53

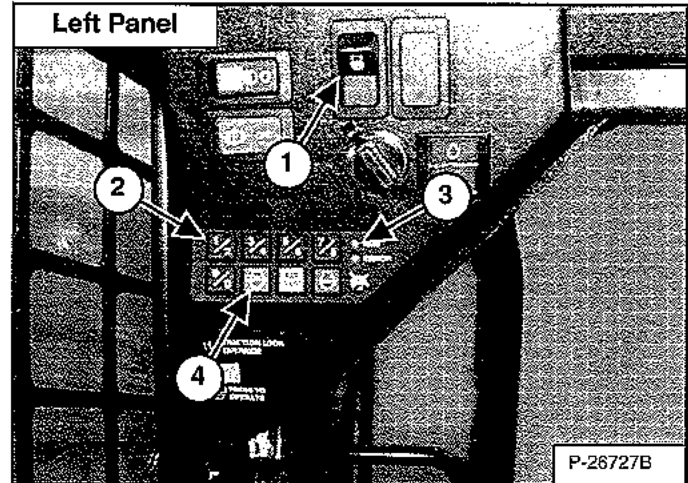

Earlier Models With Preheat Switch (Item 1)

Enter the password / user code on the keypad (Item 2), the RUN light (Item 3) [Figure 53] will illuminate.

If the temperature is cold, press and hold the top of the preheat switch (Item 1) [Figure 53]. Release the switch to stop engine preheat.

A decal in the operator cab and the table below show suggested preheat times.

AMBIENT AIR TEMPERATURE	PREHEAT TIME
21°C and Above (70°F and Above)	None Required
10 - 21°C (50 - 70°F)	5 Seconds
-18 - 10°C (0 - 50°F)	15 Seconds
-18°C and Below (0°F and Below)	25 Seconds

NOTE: You can hold the preheat switch for up to 25 seconds at a time while cranking.

Press the start button (Item 4) [Figure 53] and continue to crank for up to one minute or until the engine starts.

Release the start button when the engine starts.

STARTING THE ENGINE (CONT'D)

Keyless Start Panel (Cont'd)

Figure 54

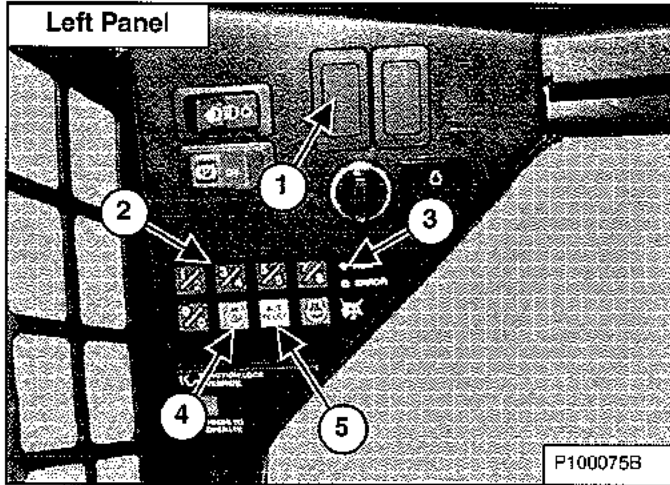

Later Models Without Preheat Switch (Item 1)

Enter the password / user code on the keypad (Item 2), the RUN light (Item 3) [Figure 54] will illuminate.

If the temperature is cold, press and hold the AUX. RELIEF / Preheat button (Item 5) [Figure 54]. Release the button to stop engine preheat.

A decal in the operator cab and the table below show suggested preheat times.

AMBIENT AIR TEMPERATURE	PREHEAT TIME
21°C and Above (70°F and Above)	None Required
10 - 21°C (50 - 70°F)	5 Seconds
-18 - 10°C (0 - 50°F)	15 Seconds
-18°C and Below (0°F and Below)	25 Seconds

NOTE: You can hold the AUX. RELIEF / Preheat button for up to 25 seconds at a time while cranking.

Press the start button (Item 4) [Figure 54] and continue to crank for up to one minute or until the engine starts.

Release the start button when the engine starts.

All Models

Figure 55

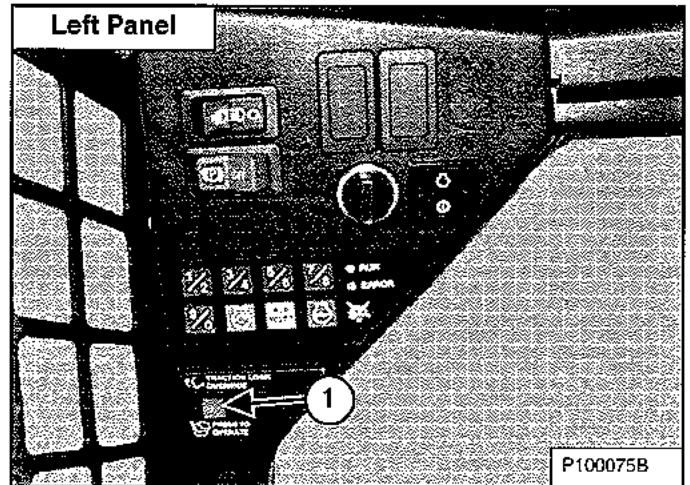
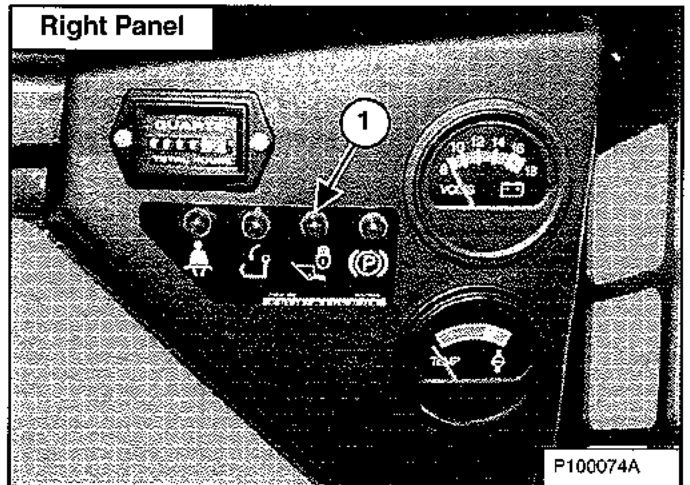

Figure 56



Press the PRESS TO OPERATE LOADER button (Item 1) [Figure 55] to activate the BICS™ and to perform hydraulic and loader functions. The Lift & Tilt Valve light (Item 1) [Figure 56] will be OFF when the BICS™ is active.



WARNING

AVOID INJURY OR DEATH

When an engine is running in an enclosed area, fresh air must be added to avoid concentration of exhaust fumes. If the engine is stationary, vent the exhaust outside. Exhaust fumes contain odorless, invisible gases which can kill without warning.

W-2050-0807

STARTING THE ENGINE (CONT'D)

Cold Temperature Starting

! WARNING

AVOID INJURY OR DEATH

Do not use ether with glow plug (preheat) systems. Explosion can result which can cause injury, death, or severe engine damage.

W-2071-0907

If the temperature is below freezing perform the following to make starting the engine easier:

- Replace the engine oil with the correct type and viscosity for the anticipated starting temperature (See Engine Oil Chart on Page 88.)
- Make sure the battery is fully charged.
- Install an engine heater, available from your local Bobcat dealer.

Warming The Hydraulic / Hydrostatic System

IMPORTANT

When the temperature is below -30°C (-20°F), hydrostatic oil must be warmed before starting. The hydrostatic system will not get enough oil at low temperatures and will be damaged. Park the machine in an area where the temperature will be above -18°C (0°F) if possible.

I-2007-0910

Let the engine run for a minimum of 5 minutes to warm the engine and hydrostatic transmission fluid before operating the loader.

MONITORING THE DISPLAY PANELS

Right Panel

Figure 57

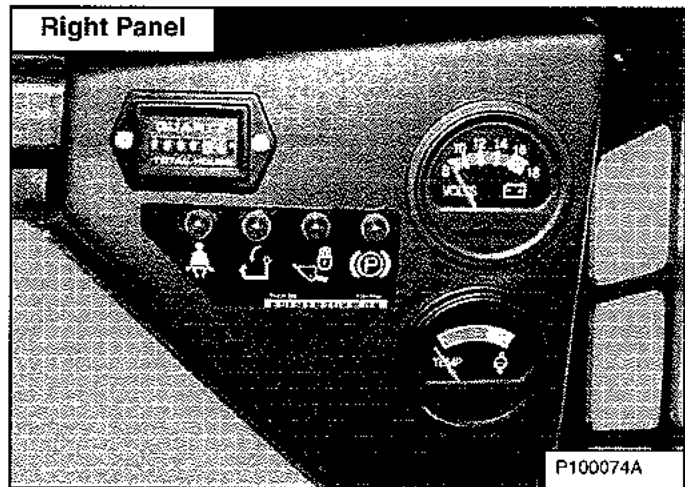

Frequently monitor the temperature gauge and BICS™ lights [Figure 57]. All BICS™ lights must be off to operate the loader. (See BOBCAT INTERLOCK CONTROL SYSTEM (BICS™) on Page 72.)

STOPPING THE ENGINE AND LEAVING THE LOADER

Procedure

Stop the Bobcat Loader on level ground.

Lower the lift arms fully and put the attachment flat on the ground.

Figure 58

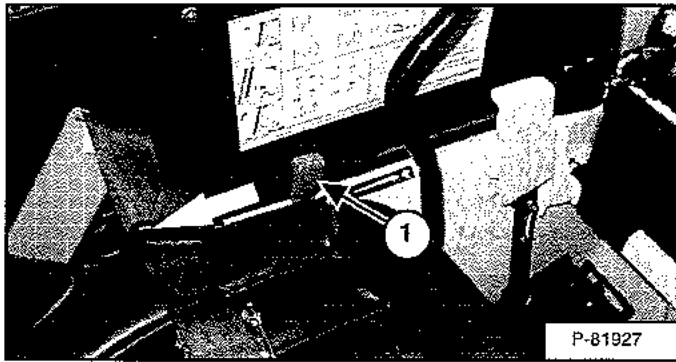

Pull the engine speed control lever (Item 1) [Figure 58] fully backward to decrease the engine speed.

Figure 59

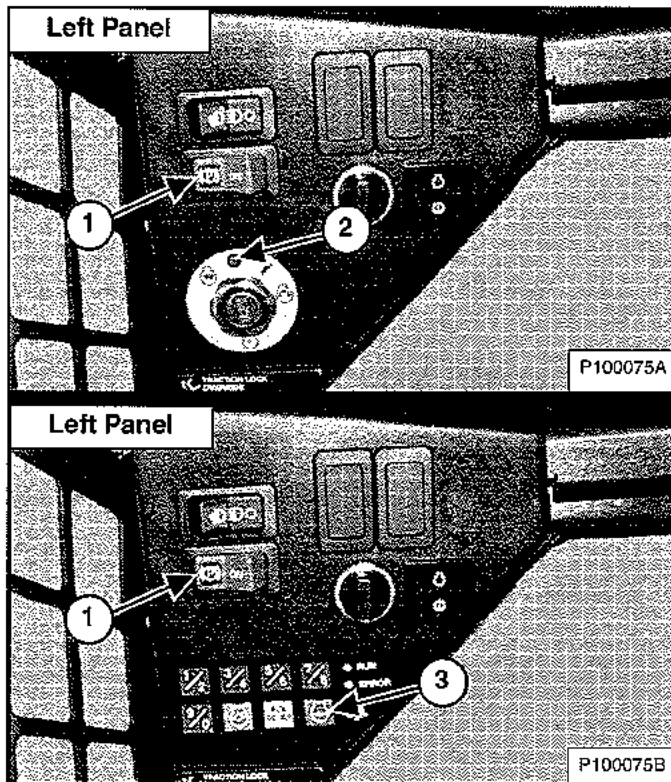

Turn the key switch to the OFF position (Item 2) or press the STOP button (Item 3) [Figure 59].

Engage the parking brake by pressing the left side of the parking brake switch (Item 1) [Figure 59].

Raise the seat bar and make sure the lift and tilt functions are deactivated. Move the pedals until they both lock.

Move auxiliary hydraulic control lever out of detent position.

Unbuckle the seat belt.

Remove the key from the switch to prevent operation of the loader by unauthorized personnel. (Standard Key Panel only.)

Figure 60



Exit the loader using grab handles, safety tread and steps (maintaining a 3-point contact) [Figure 60].

WARNING

Before you leave the operator's seat:

- Lower the lift arms, put the attachment flat on the ground.
- Stop the engine.
- Engage the parking brake.
- Raise the seat bar, move pedals until both lock.
- Move auxiliary hydraulic control lever out of detent position.

W-2164-0108

ATTACHMENTS

Choosing The Correct Bucket

! WARNING

AVOID INJURY OR DEATH

Never use attachments or buckets which are not approved by Bobcat Company. Buckets and attachments for safe loads of specified densities are approved for each model. Unapproved attachments can cause injury or death.

W-2052-0907

NOTE: Warranty is void if non-approved attachments are used on the Bobcat Loader.

The dealer can identify, for each model loader, the attachments and buckets approved by Bobcat. The buckets and attachments are approved for Rated Operating Capacity (ROC) and for secure fastening to the Bob-Tach.

The ROC for this loader is shown on a decal in the operator cab. (See Performance on Page 130.)

The ROC is determined by using a standard bucket, and material of normal density, such as dirt or dry gravel. If longer buckets are used, the load center moves forward and reduces the ROC. If very dense material is loaded, the volume must be reduced to prevent overloading.

Figure 61

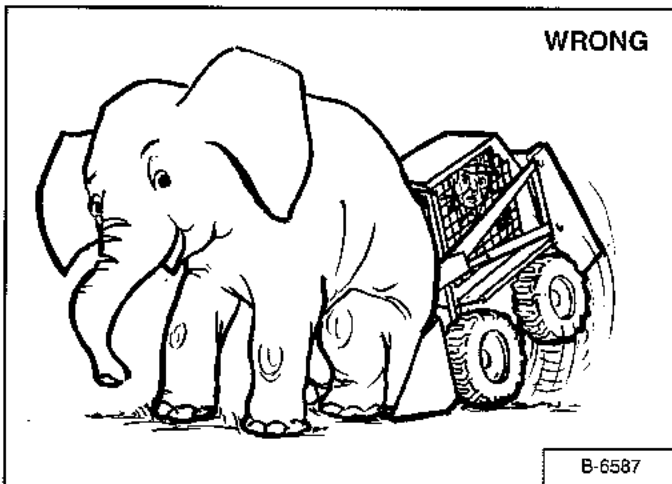

Exceeding the ROC [Figure 61] can cause the following problems:

- Steering the loader may be difficult.
- Tires will wear faster.
- There will be a loss of stability.
- The life of the Bobcat Loader will be reduced.

Use the correct bucket size for the type and density of material being handled. For safe handling of materials and avoiding machine damage, the attachment (or bucket) should handle a full load without going over the ROC for the loader. Partial loads make steering more difficult.

Pallet Forks

Figure 62

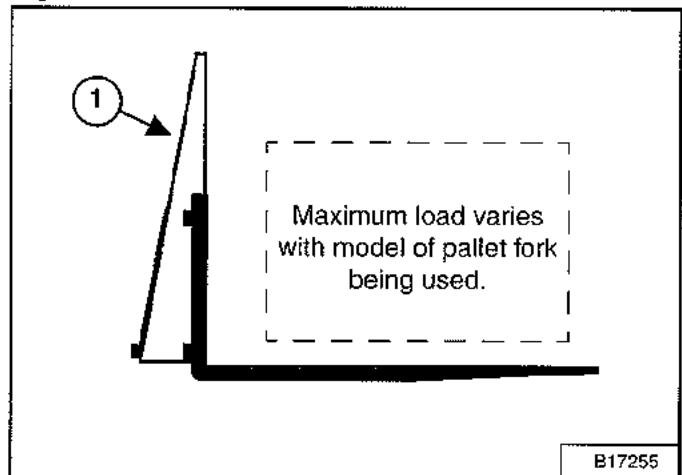

The maximum load to be carried when using a pallet fork is shown on a decal located on the pallet fork frame (Item 1) [Figure 62].

See your Bobcat dealer for more information about pallet fork inspection, maintenance and replacement. See your Bobcat Loader dealer for ROC when using a pallet fork and for other available attachments.

! WARNING

AVOID INJURY OR DEATH

Do not exceed Rated Operating Capacity (ROC). Excessive load can cause tipping or loss of control.

W-2053-0903

ATTACHMENTS (CONT'D)

Installing And Removing The Attachment

The Bob-Tach is used for fast changing of buckets and attachments. See the appropriate attachment Operation & Maintenance Manual to install other attachments.

Installing

Figure 63

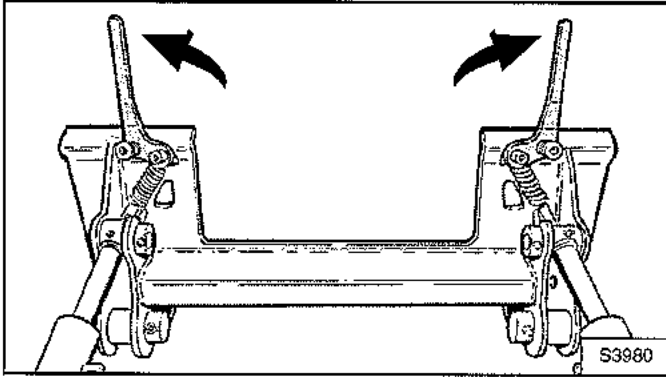

Pull the Bob-Tach levers all the way up [Figure 63].

Enter the loader and perform the PRE-STARTING PROCEDURE. (See PRE-STARTING PROCEDURE on Page 45.) Start the engine.

Lower the lift arms and tilt the Bob-Tach slightly forward.

Figure 64

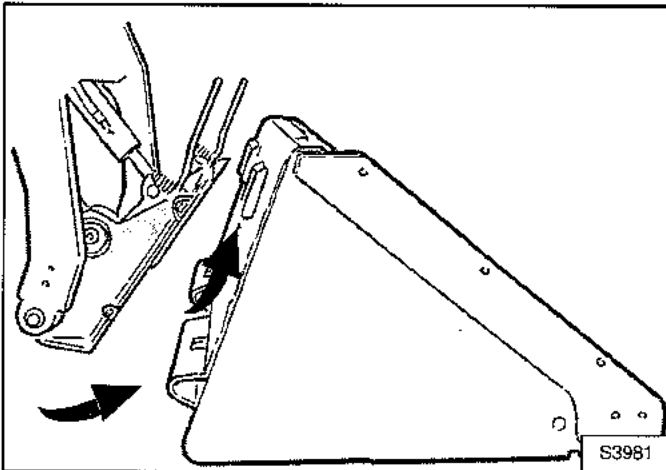

Disengage the parking brake and drive the loader forward until the top edge of the Bob-Tach is completely under the top flange of the bucket [Figure 64] (or other attachment).

NOTE: Make sure the Bob-Tach levers do not hit the bucket (or other attachment).

Figure 65

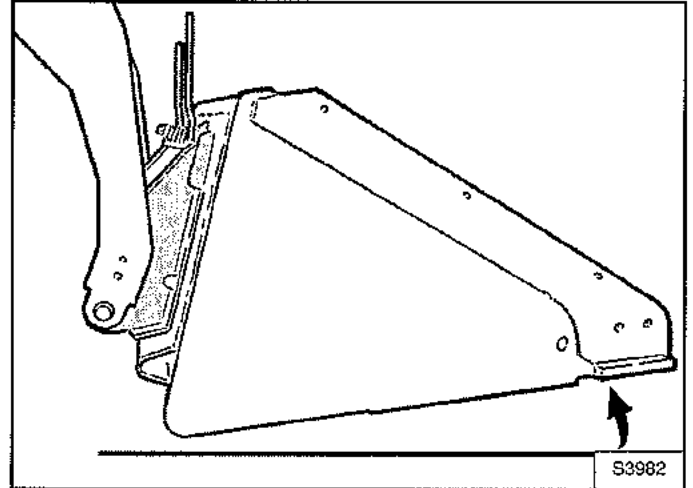

Tilt the Bob-Tach backward until the cutting edge of the bucket (or other attachment) is slightly off the ground [Figure 65]. This will cause the bucket frame to fit up against the front of the Bob-Tach.

! WARNING

Before you leave the operator's seat:

- Lower the lift arms, put the attachment flat on the ground.
- Stop the engine.
- Engage the parking brake.
- Raise the seat bar, move pedals until both lock.
- Move auxiliary hydraulic control lever out of detent position.

W-2164-0108

Stop the engine, engage the parking brake, raise the seat bar, unfasten the seat belt and exit the loader.

ATTACHMENTS (CONT'D)

Installing And Removing The Attachment (Cont'd)

Installing (Cont'd)

Figure 66

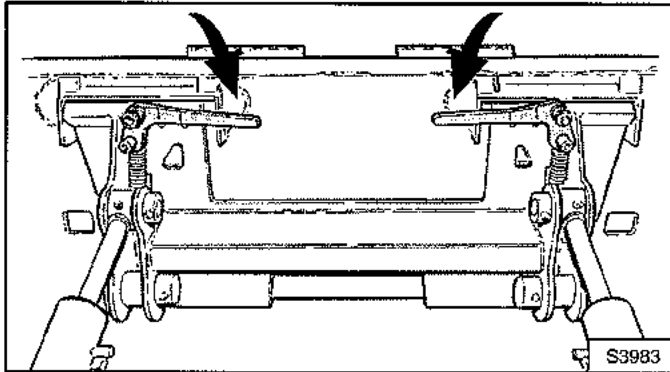

Push down on the Bob-Tach levers until they are fully engaged in the locked position [Figure 66].

Figure 67

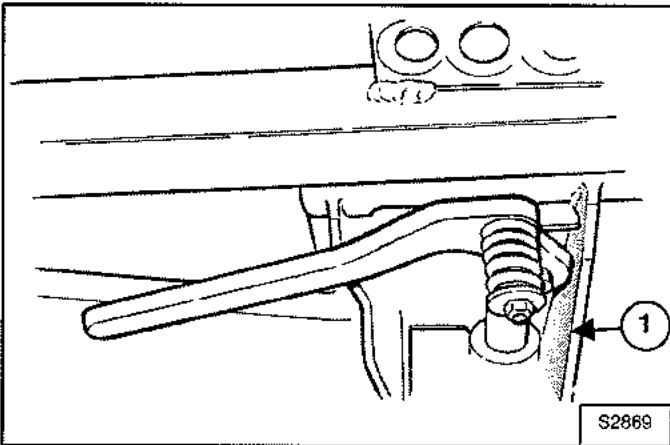

The levers must contact the frame at the shaded areas (Item 1) [Figure 67] (wedges fully extended).

If the levers do not engage in the locked position, contact your Bobcat dealer for maintenance.

Figure 68



The wedges must extend through the holes in the mounting frame of the bucket (or attachment) and touch the lower edge of these holes, securely fastening the bucket to the Bob-Tach [Figure 68].

WARNING

AVOID INJURY OR DEATH

The Bob-Tach wedges must extend through the holes in the attachment mounting frame. Levers must be fully down and locked. Failure to secure wedges can allow attachment to come off.

W-2715-0208

If the attachment is hydraulically controlled, connect the hydraulic hoses of the attachment to the loader (See Quick Couplers on Page 41.) You may need to release hydraulic pressure before connecting the quick couplers. (See Relieve Auxiliary Hydraulic Pressure (Loader And Attachment) on Page 41.)

ATTACHMENTS (CONT'D)

Installing And Removing The Attachment (Cont'd)

Removing

- Lower the lift arms, put the attachment flat on the ground and lower or close the hydraulic equipment.
- If the attachment is hydraulically controlled (Combination bucket, backhoe, etc.): stop the engine and relieve hydraulic pressure in the auxiliary circuit (See Relieve Auxiliary Hydraulic Pressure (Loader And Attachment) on Page 41.)
- Stop the engine, engage the parking brake, raise the seat bar, unfasten the seat belt and exit the loader.
- Disconnect the hydraulic hoses from the attachment.

! WARNING

Before you leave the operator's seat:

- Lower the lift arms, put the attachment flat on the ground.
- Stop the engine.
- Engage the parking brake.
- Raise the seat bar, move pedals until both lock.
- Move auxiliary hydraulic control lever out of detent position.

W-2164-0108

Figure 69

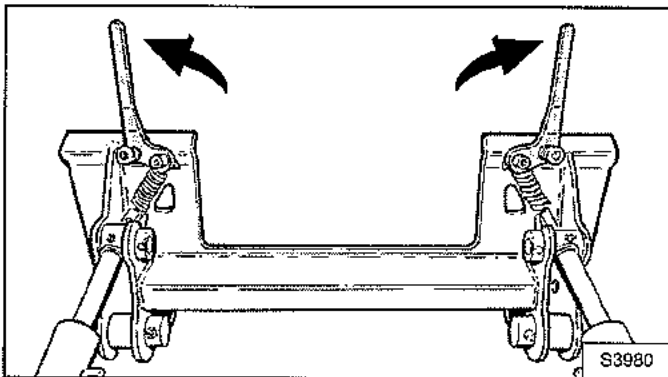

Pull the Bob-Tach levers all the way up [Figure 69].

! WARNING

Bob-Tach levers have spring tension. Hold lever tightly and release slowly. Failure to obey warning can cause injury.

W-2054-1285

Enter the loader and perform the PRE-STARTING PROCEDURE. (See PRE-STARTING PROCEDURE on Page 45.) Start the engine and disengage the parking brake.

Figure 70

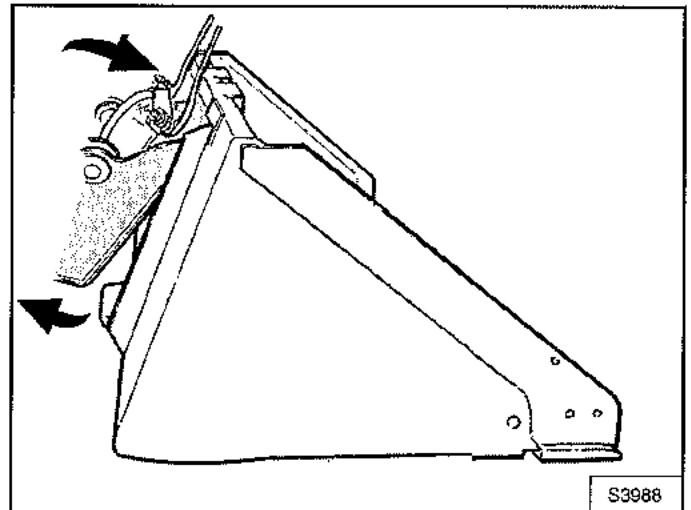

Tilt the Bob-Tach forward while backing the loader away from the bucket or attachment [Figure 70].

NOTE: In muddy conditions or to prevent the attachment from freezing to the ground, put the attachment on planks or blocks before removing it from the machine.

OPERATING PROCEDURE

Inspect The Work Area

Before beginning operation, inspect the work area for unsafe conditions.

Look for sharp drop-offs or rough terrain. Have underground utility lines (gas, electrical, water, sewer, irrigation, etc.) located and marked.

Remove objects or other construction material that could damage the loader or cause personal injury.

Always check ground conditions before starting your work:

- Inspect for signs of instability such as cracks or settlement.
- Be aware of weather conditions that can affect ground stability.
- Check for adequate traction if working on a slope.

Basic Operating Instructions

Always warm the engine and hydrostatic system before operating the loader.

IMPORTANT

Machines warmed up with moderate engine speed and light load have longer life.

I-2015-0284

Operate the loader with engine at full speed for maximum horsepower. Move the steering levers only a small amount to operate the loader slowly.

New operators must operate the loader in an open area without bystanders. Operate the controls until the loader can be handled at an efficient and safe rate for all conditions of the work area.

Operating Near An Edge Or Water

Keep the loader as far back from the edge as possible and the loader wheels perpendicular to the edge so that if part of the edge collapses, the loader can be moved back.

Always move the loader back at any indication the edge may be unstable.



WARNING

MACHINE TIPPING OR ROLLOVER CAN CAUSE SERIOUS INJURY OR DEATH

- **Keep the lift arms as low as possible.**
- **Do not travel or turn with the lift arms up.**
- **Turn on level ground. Slow down when turning.**
- **Go up and down slopes, not across them.**
- **Keep the heavy end of the machine uphill.**
- **Do not overload the machine.**
- **Check for adequate traction.**

W-2018-1112

Driving On Public Roads

When operating on a public road or highway, always follow local regulations. For example: Slow Moving Vehicle Sign or direction signals may be required.

OPERATING PROCEDURE (CONT'D)

Operating With A Full Bucket

Figure 71

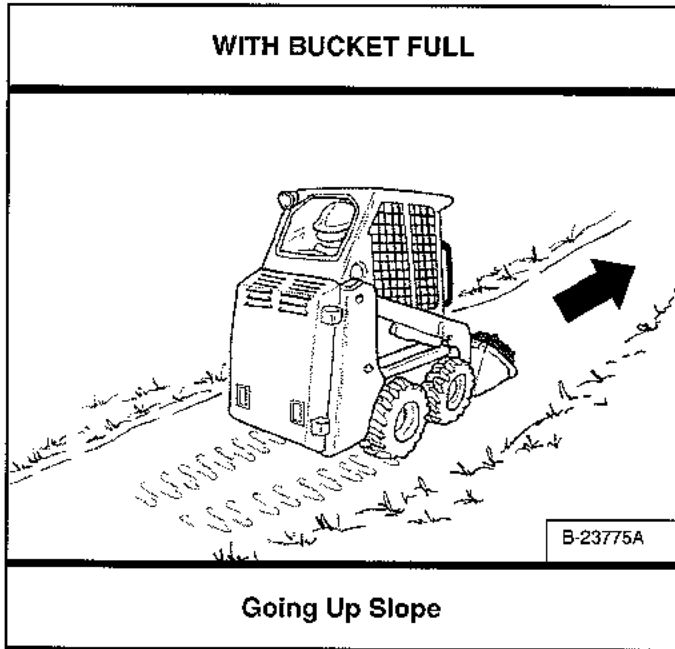

Operating With An Empty Bucket

Figure 73

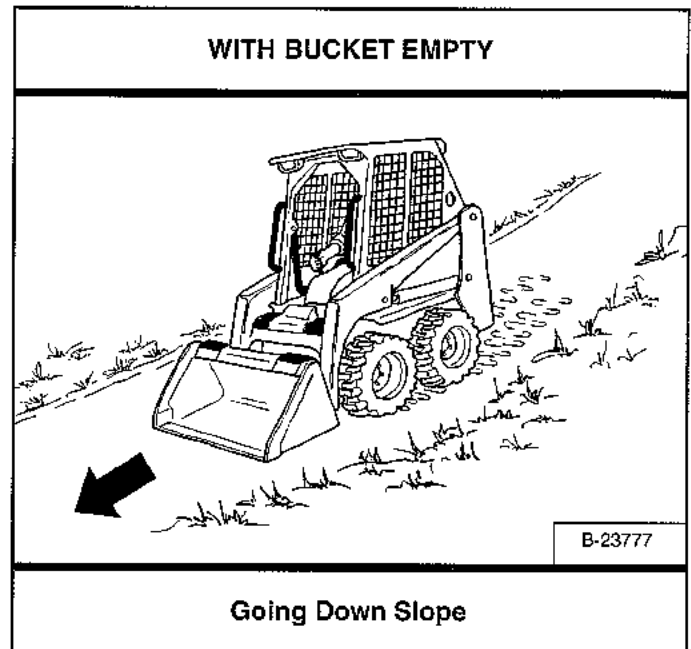

Figure 72

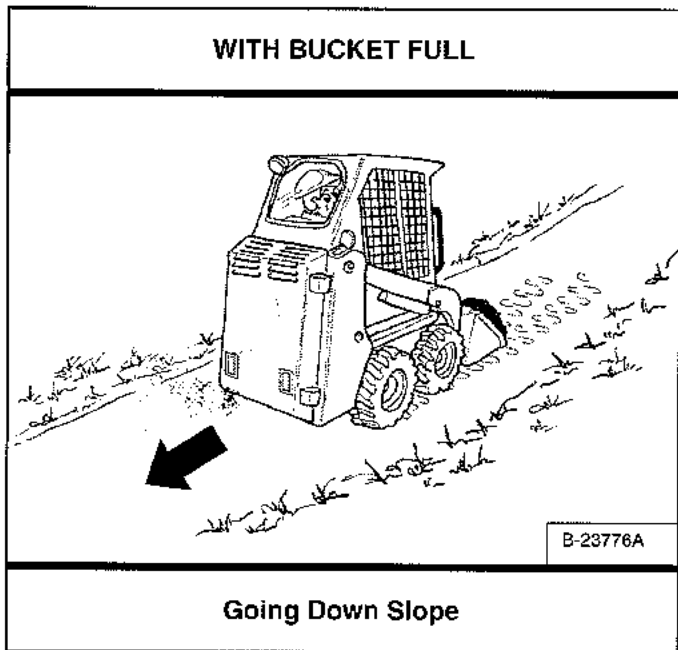
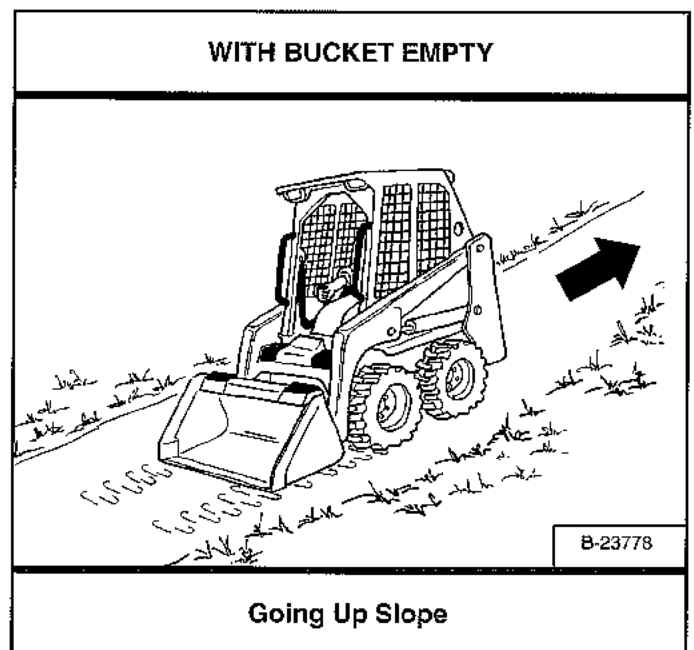

Figure 74



With a full bucket, go up or down the slope with the bucket (heavy end) toward the top of the slope [Figure 71] and [Figure 72].

With an empty bucket, go up or down the slope with the back of the loader (heavy end) toward the top of the slope [Figure 73] and [Figure 74].

Raise the bucket only high enough to avoid obstructions on rough ground.

OPERATING PROCEDURE (CONT'D)

Filling And Emptying The Bucket

Filling

Figure 75

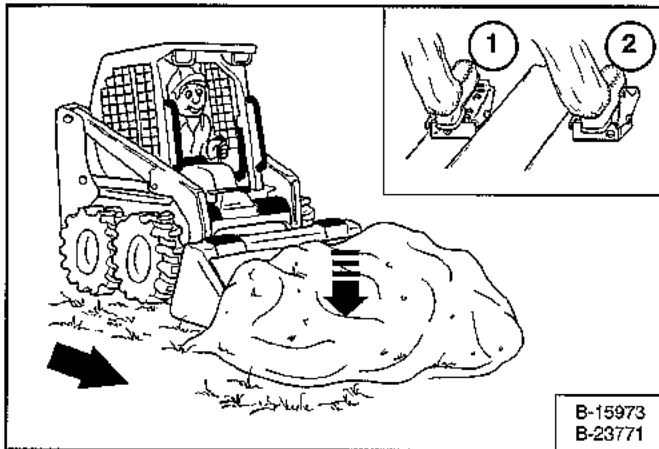
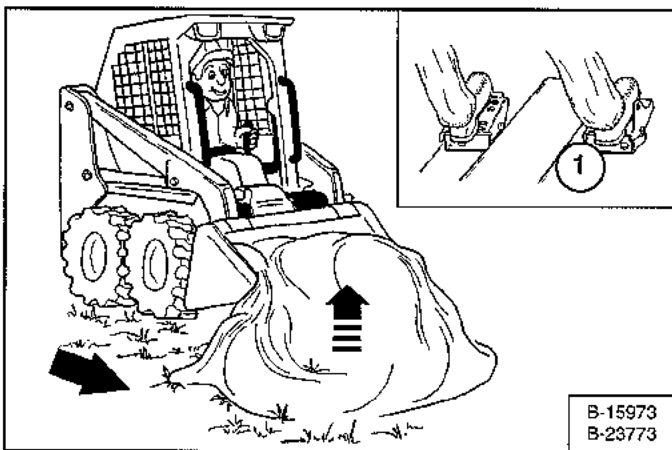

Figure 76



Lower the lift arms all the way by pushing the toe of the left pedal (Item 1) [Figure 75]. Tilt the bucket forward by pushing the toe of the right pedal (Item 2) [Figure 75] until the cutting edge of the bucket is on the ground.

Drive slowly forward into the material. Tilt the bucket backward all the way by pushing the heel of the right pedal (Item 1) [Figure 76] when the bucket is full.

Drive backward away from the material.

! WARNING

Load, unload and turn on flat level ground. Do not exceed Rated Operating Capacity (ROC) shown on sign (decal) in cab. Failure to obey warnings can cause the machine to tip or rollover and cause injury or death.

W-2056-1112

Emptying

Figure 77

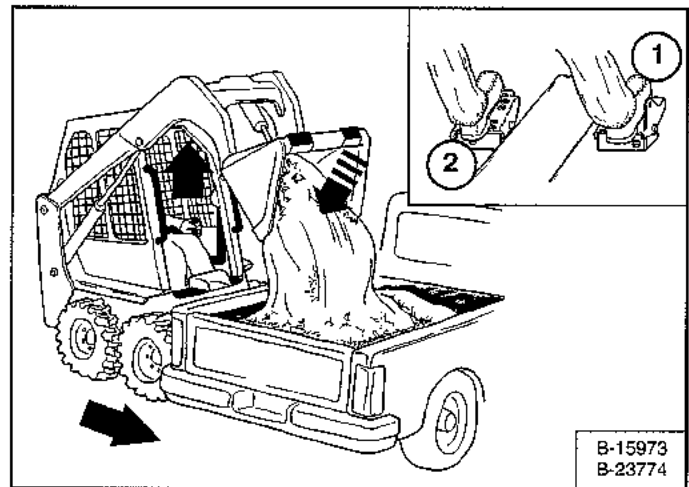

Keep the bucket low when moving to the area where you want to empty the bucket.

Level the bucket by pushing the toe of the right pedal (Item 1) while raising the lift arms to help prevent material from falling off the back of the bucket. Raise the lift arms by pushing the heel of the left pedal (Item 2) [Figure 77].

Drive forward slowly until the bucket is over the top of the truck box or bin [Figure 77].

Empty the bucket by pushing the toe of the right pedal (Item 1) [Figure 77]. If all the material is near the side of the truck or bin, use the bucket tilt to move it to the other side.

! WARNING

Never dump over an obstruction, such as a post, that can enter the operator cab. The machine could tip forward and cause injury or death.

W-2057-0694

OPERATING PROCEDURE (CONT'D)

Leveling The Ground Using Float

Figure 78

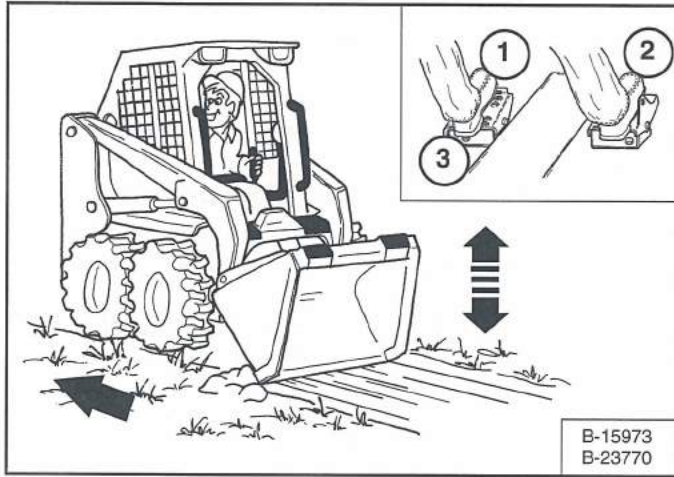

Put the lift arms in *float* position by pushing the toe of the left pedal (Item 1) [Figure 78] until it is locked in the forward position.

Tilt the bucket forward by pushing the toe of the right pedal (Item 2) [Figure 78] to change the position of the cutting edge of the bucket.

With the bucket tilted farther forward, there is more force on the cutting edge and more loose material can be moved.

Drive backward to level loose material [Figure 78].

Push the heel of the left pedal (Item 3) [Figure 78] to unlock the float position.

IMPORTANT

Never drive forward when the hydraulic control for lift arms is in float position.

I-2005-1285

Digging And Filling A Hole

Digging

Figure 79



Lower the lift arms all the way by pushing the toe of the left pedal (Item 1) [Figure 79]. Put the cutting edge of the bucket on the ground by pushing the toe of the right pedal (Item 2) [Figure 79].

Drive forward slowly and continue to tilt the bucket down (Item 2) [Figure 79] until it enters the ground.

Raise the cutting edge a small amount by pushing the heel of the right pedal (Item 3) [Figure 79] to increase traction and keep an even digging depth. Continue to drive forward until the bucket is full. When the ground is hard, raise and lower the cutting edge of the bucket (Items 2 and 3) [Figure 79] while driving forward slowly.

Figure 80

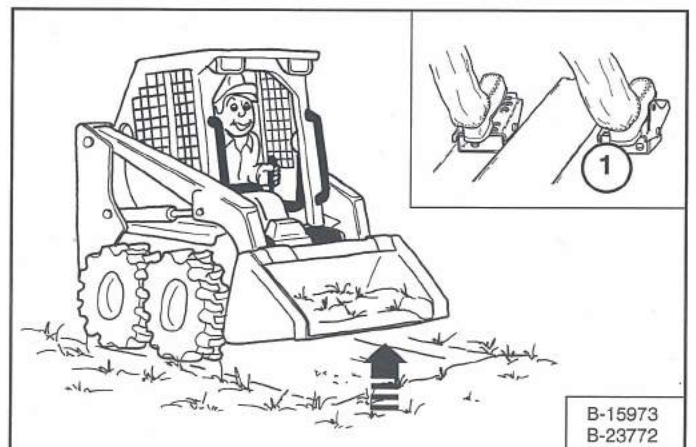

Tilt the bucket backward by pushing the heel of the right pedal (Item 1) [Figure 80] as far as it will go when the bucket is full.

OPERATING PROCEDURE (CONT'D)

Digging And Filling A Hole (Cont'd)

Filling

Figure 81

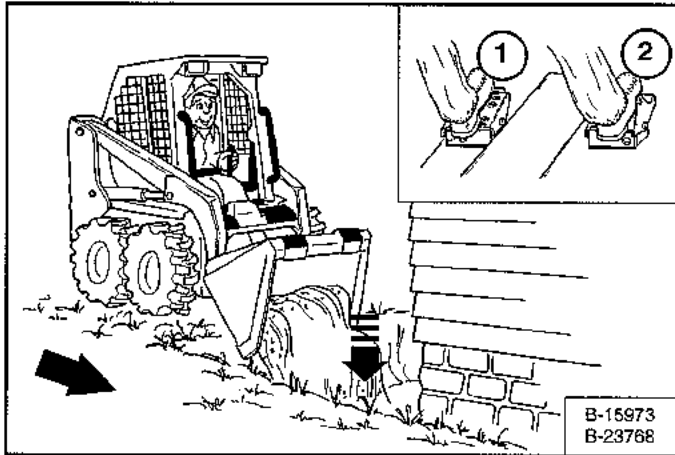

Lower the lift arms by pushing the toe of the left pedal (Item 1) [Figure 81]. Put the cutting edge of the bucket on the ground by pushing the toe of the right pedal (Item 2) [Figure 81]. Drive forward to the edge of the hole to push the material into the hole.

Tilt the bucket farther forward (Item 2) [Figure 81] as soon as it is past the edge of the hole.

If necessary, raise the lift arms to empty the bucket.

TOWING THE LOADER

Procedure

Because of the design of the loader, there is not a recommended towing procedure.

- The loader can be lifted onto a transport vehicle.
- The loader can be skidded a short distance to move for service (EXAMPLE: Move onto a transport vehicle.) without damage to the hydrostatic system. (The wheels will not turn.) There might be slight wear to the tires when the loader is skidded.

The towing chain (or cable) must be rated at 1.5 times the weight of the loader. (See Performance on Page 130.)

LIFTING THE LOADER

Single-Point Lift

! WARNING

AVOID INJURY OR DEATH

- Before lifting, check fasteners on single point lift and operator cab.
- Assemble front cab fasteners as shown in this manual.
- Never allow riders in the cab or bystanders within 5 m (15 ft) while lifting the machine.

W-2007-0910

The loader can be lifted with the Single-Point Lift which is available as a kit from your Bobcat Loader dealer.

The Single-Point Lift, supplied by Bobcat, is designed to lift and support the Bobcat Loader without affecting rollover and falling object protection features of the operator cab.

Figure 82

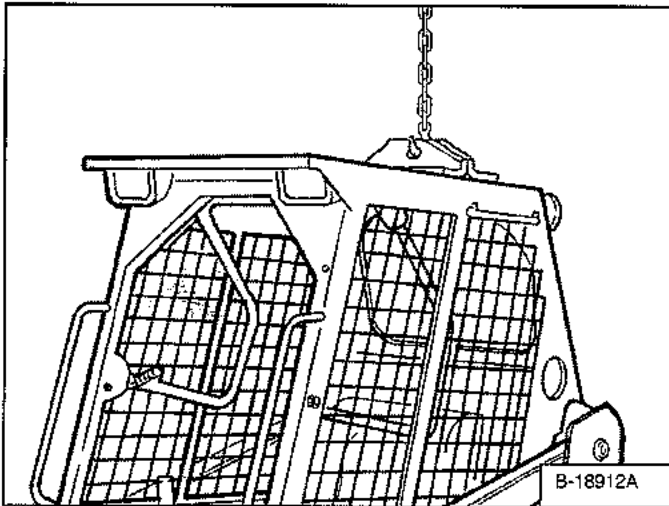

Attach lift to lift eye [Figure 82].

NOTE: Be sure the lifting equipment is of adequate size and capacity for the weight of the loader. (See Performance on Page 130.)

TRANSPORTING THE LOADER ON A TRAILER

Loading And Unloading

! WARNING

AVOID SERIOUS INJURY OR DEATH

Adequately designed ramps of sufficient strength are needed to support the weight of the machine when loading onto a transport vehicle. Wood ramps can break and cause personal injury.

W-2058-0807

Be sure the transport and towing vehicles are of adequate size and capacity for the weight of the loader. (See Performance on Page 130.)

Figure 83

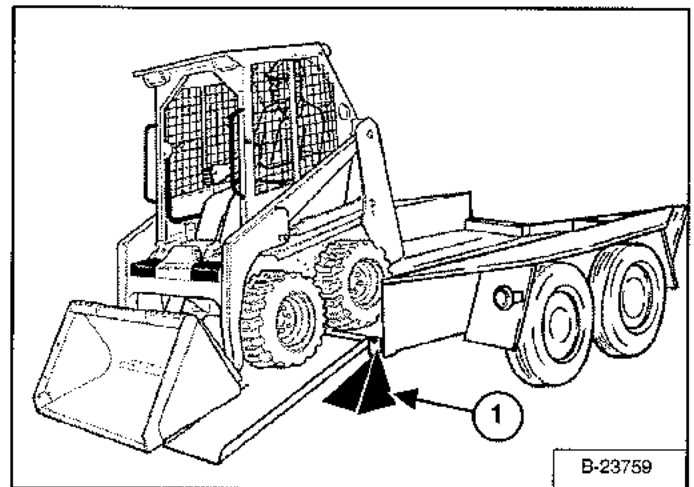

A loader with an empty bucket or no attachment must be loaded backward onto the transport vehicle [Figure 83].

The rear of the trailer must be blocked or supported (Item 1) [Figure 83] when loading or unloading the loader to prevent the front end of the trailer from raising up.

TRANSPORTING THE LOADER ON A TRAILER (CONT'D)

Fastening

Figure 84

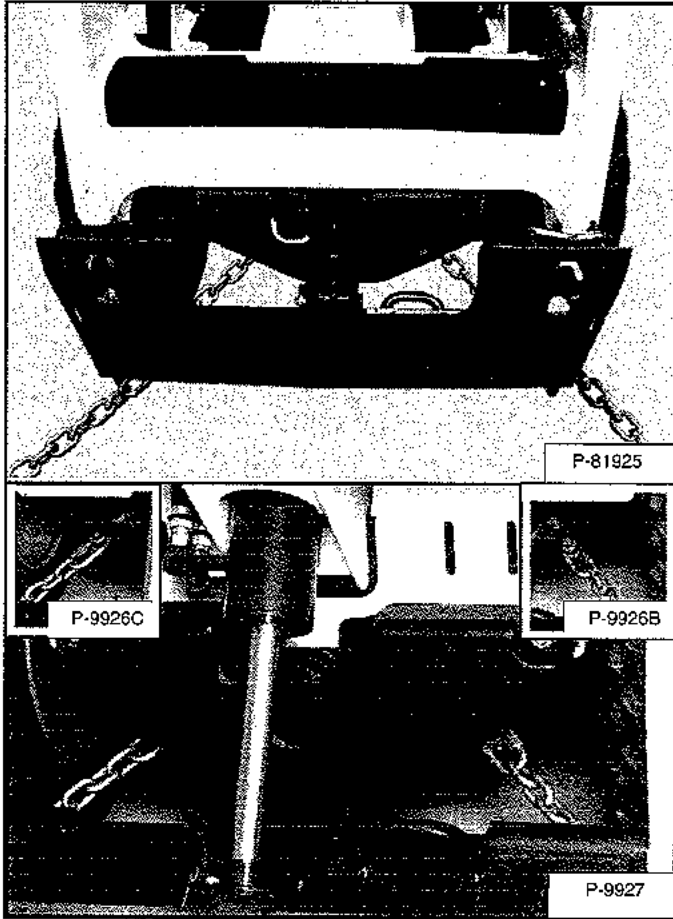
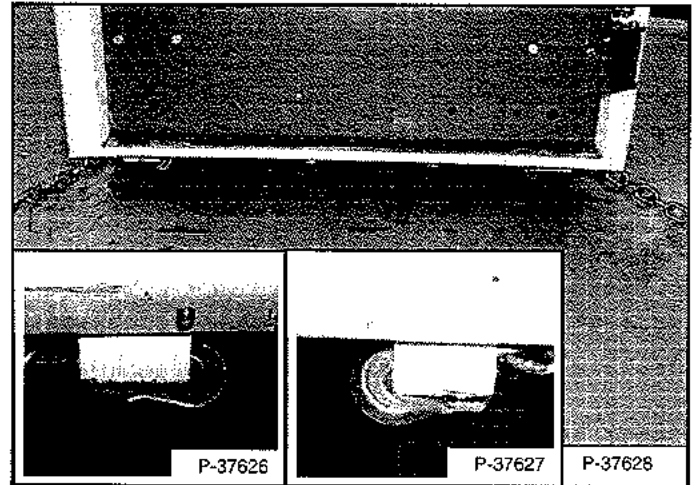

Figure 85



- Install chains at the rear tie down positions [Figure 85].
- Fasten each end of the chain to the transport vehicle.

Use the following procedure to fasten the Bobcat Loader to the transport vehicle to prevent the loader from moving during sudden stops or when going up or down slopes [Figure 84].

- Lower the bucket or attachment to the floor.
- Stop the engine.
- Engage the parking brake.
- Install chains at the front tie down positions [Figure 84].
- Fasten each end of the chain to the transport vehicle.

PREVENTIVE MAINTENANCE

MAINTENANCE SAFETY	69
SERVICE SCHEDULE	71
Chart	71
BOBCAT INTERLOCK CONTROL SYSTEM (BICS™)	72
Inspecting The BICS™ (Engine STOPPED - Key ON)	72
Inspecting The Seat Bar Sensor (Engine RUNNING)	72
Inspecting The Traction Lock (Engine RUNNING)	72
Inspecting The Lift Arm Bypass Control	72
Inspecting Deactivation Of The Auxiliary Hydraulics System	73
SEAT BAR RESTRAINT SYSTEM	74
Description	74
Inspecting	74
Maintaining	74
SEAT BELT	75
Inspection And Maintenance	75
LIFT ARM SUPPORT DEVICE	76
Installing	76
Removing	77
BACK-UP ALARM SYSTEM	78
Description	78
Inspecting	78
Adjusting Switch Position	79
OPERATOR CAB	80
Description	80
Raising	80
Lowering	81
REAR DOOR (TAILGATE)	83
Opening And Closing	83
AIR CLEANER SERVICE	84
Replacing Filter Elements	84
FUEL SYSTEM	85
Fuel Specifications	85
Biodiesel Blend Fuel	85
Filling The Fuel Tank	86
Fuel Filter	87
Removing Air From The Fuel System	87

ENGINE LUBRICATION SYSTEM	88
Checking And Adding Engine Oil	88
Engine Oil Chart	88
Removing And Replacing Oil And Filter	88
ENGINE COOLING SYSTEM	89
Cleaning	89
Checking Level	89
Removing And Replacing Coolant	90
ELECTRICAL SYSTEM	91
Description	91
Fuse And Relay Location / Identification	91
Battery Maintenance	92
Using A Booster Battery (Jump Starting)	92
Removing And Installing Battery	94
HYDRAULIC / HYDROSTATIC SYSTEM	95
Checking And Adding Fluid	95
Hydraulic / Hydrostatic Fluid Chart	95
Removing And Replacing Hydraulic Fluid	96
Removing And Replacing Hydraulic / Hydrostatic Filter	97
Breather Cap	97
SPARK ARRESTER MUFFLER	98
Cleaning Procedure	98
TIRE MAINTENANCE	99
Wheel Nuts	99
Rotating	99
Mounting	99
FINAL DRIVE TRANSMISSION (CHAINCASE)	100
Checking And Adding Oil	100
Removing And Replacing Oil	100
ALTERNATOR BELT	101
Belt Adjustment	101
Belt Replacement	101
DRIVE BELT	102
Belt Adjustment	102
Belt Replacement	102
LUBRICATING THE LOADER	103
Lubrication Locations	103
PIVOT PINS	105
Inspection And Maintenance	105

BOB-TACH106
 Inspection And Maintenance106

LOADER STORAGE AND RETURN TO SERVICE107
 Storage107
 Return To Service107



Bobcat®

MAINTENANCE SAFETY



WARNING

Instructions are necessary before operating or servicing machine. Read and understand the Operation & Maintenance Manual, Operator's Handbook and signs (decals) on machine. Follow warnings and instructions in the manuals when making repairs, adjustments or servicing. Check for correct function after adjustments, repairs or service. Untrained operators and failure to follow instructions can cause injury or death.

W-2003-0807



Safety Alert Symbol: This symbol with a warning statement, means: "Warning, be alert! Your safety is involved!" Carefully read the message that follows.

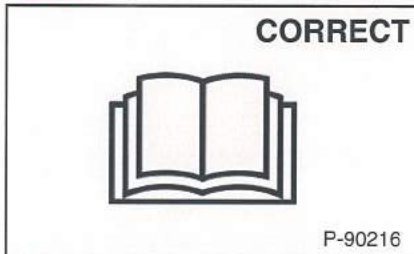

P-90216

- ⚠ Never service the Bobcat Skid-Steer Loader without instructions.

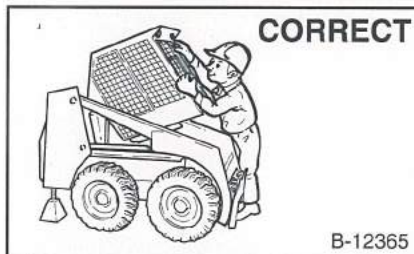

B-12365

- ⚠ Use the correct procedure to lift or lower operator cab.



B-7469

- ⚠ Cleaning and maintenance are required daily.

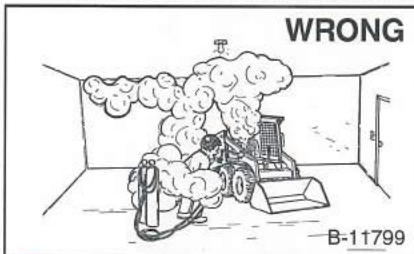

B-11799

- ⚠ Have good ventilation when welding or grinding painted parts.
- ⚠ Wear dust mask when grinding painted parts. Toxic dust and gas can be produced.
- ⚠ Avoid exhaust fume leaks which can kill without warning. Exhaust system must be tightly sealed.

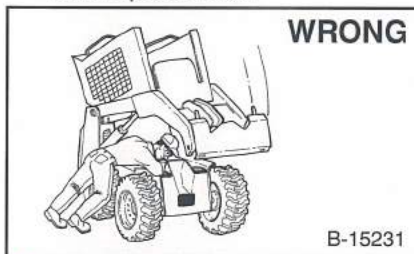

B-15231

- ⚠ Disconnecting or loosening any hydraulic tubeline, hose, fitting, component or a part failure can cause lift arms to drop. Do not go under lift arms when raised unless supported by an approved lift arm support device. Replace it if damaged.

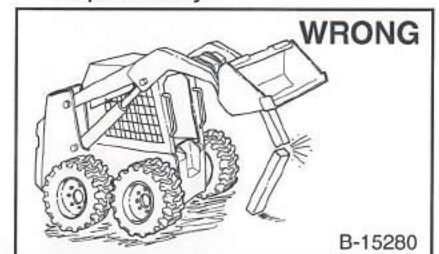

B-15280

- ⚠ Never work on loader with lift arms up unless lift arms are held by an approved lift arm support device. Replace if damaged.
- ⚠ Never modify equipment or add attachments not approved by Bobcat Company.

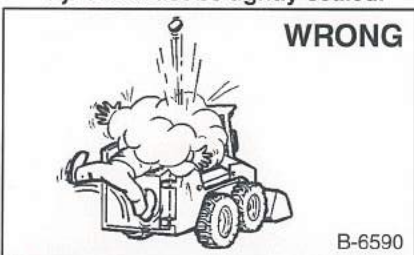

B-6590

- ⚠ Stop, cool and clean engine of flammable materials before checking fluids.
- ⚠ Never service or adjust loader with the engine running unless instructed to do so in the manual.
- ⚠ Avoid contact with leaking hydraulic fluid or diesel fuel under pressure. It can penetrate the skin or eyes.
- ⚠ Never fill fuel tank with engine running, while smoking or when near open flame.



B-6580

- ⚠ Keep body, jewelry and clothing away from moving parts, electrical contact, hot parts and exhaust.
- ⚠ Wear eye protection to guard from battery acid, compressed springs, fluids under pressure and flying debris when engines are running or tools are used. Use eye protection approved for type of welding.
- ⚠ Keep rear door closed except for service. Close and latch door before operating the loader.



B-6589

- ⚠ Lead-acid batteries produce flammable and explosive gases.
- ⚠ Keep arcs, sparks, flames and lighted tobacco away from batteries.
- ⚠ Batteries contain acid which burns eyes or skin on contact. Wear protective clothing. If acid contacts body, flush well with water. For eye contact flush well and get immediate medical attention.

Maintenance procedures which are given in the Operation & Maintenance Manual can be performed by the owner/operator without any specific technical training. Maintenance procedures which are not in the Operation & Maintenance Manual must be performed **ONLY BY QUALIFIED BOBCAT SERVICE PERSONNEL**. Always use genuine Bobcat replacement parts. The Service Safety Training Course is available from your Bobcat dealer.

MSW01-0409



Bobcat®

SERVICE SCHEDULE

Chart

Maintenance work must be done at regular intervals. Failure to do so will result in excessive wear and early failures. The service schedule is a guide for correct maintenance of the Bobcat Loader.

 <b style="font-size: 24pt; margin-left: 10px;">WARNING	<p>Instructions are necessary before operating or servicing machine. Read and understand the Operation & Maintenance Manual, Operator's Handbook and signs (decals) on machine. Follow warnings and instructions in the manuals when making repairs, adjustments or servicing. Check for correct function after adjustments, repairs or service. Untrained operators and failure to follow instructions can cause injury or death.</p> <p style="text-align: right; font-size: 10pt;">W-2003-0807</p>
--	--

SERVICE SCHEDULE		HOURS						
ITEM	SERVICE REQUIRED	8-10	50	100	150	■ 250	■ 500	■ 1000
Engine Oil	Check the oil level and add as needed. Do not overfill.							
Engine Air Filter and Air System	Check condition indicator. Service only when required. Check for leaks and damaged components.							
Engine Cooling System	Clean debris from oil cooler, radiator and e. Check coolant level COLD and add premixed coolant as needed.							
Fuel Filter	Remove the trapped water.							
Lift Arms, Cylinders, Bob-Tach Pivot Pins and Wedges	Lubricate with multipurpose lithium based grease.							
Tires	Check for damaged tires and correct air pressure. Inflate to MAXIMUM pressure shown on sidewall of tire.							
Seat Bar, Control Interlocks, Seat Belt	Check the condition of seat belt. Check the seat bar and control interlocks for correct operation. Clean dirt and debris from moving parts.							
Front Horn / Back-up Alarm	Check for proper function.							
Bobcat Interlock Control Systems (BICS™)	Check for correct function. Lift and Tilt functions MUST NOT operate with seat bar raised. See details in this Manual.							
Safety Signs and Safety Treads	Check for damaged signs (decals) and safety treads. Replace any signs or safety treads that are damaged or worn.							
Operator Cab	Check the fastening bolts, washers and nuts. Check the condition of the cab.							
Indicators and Lights	Check for correct operation of all indicators and lights.							
Heater Filter (If Equipped)	Clean or replace filter as needed.							
Hydraulic Fluid, Hoses and Tubelines	Check fluid level and add as needed. Check for damage and leaks. Repair or replace as needed.							
Final Drive Trans. (Chaincase)	Check oil level and add oil as needed.							
Parking Brake, Foot Pedals and Steering Levers	Check for correct operation. Repair or adjust as needed.							
Wheel Nuts	Check for loose wheel nuts and tighten to correct torque. (See TIRE MAINTENANCE in this manual.)	☐						
Battery	Check cables, connections and electrolyte level. Add distilled water as needed.							
Spark Arrester Muffler	Empty Spark Chamber.							
Engine Oil and Filter	Replace oil and filter.		*					
Alternator Belt	Check tension and adjust as needed.							
Fuel Filter	Replace filter element.							
Steering Shaft	Grease fittings.							
Engine / Hydro. Drive Belt	Check for wear or damage. Adjust or replace as needed.		○					
Bobcat Interlock Control System (BICS™)	Check the function of the lift arm bypass control.							
Hydraulic Reservoir Breather Cap	Replace the reservoir breather cap.							
Hyd./Hydro. Filter	Replace the filter element.		●					
Final Drive Trans. (Chaincase)	Replace the fluid.							
Hydraulic Reservoir	Replace the fluid.							
Coolant	Replace the coolant							■

Every 2 years

- ☐ Check every 8 - 10 hours for the first 50 hours, then as scheduled.
- * First oil and filter change must occur at 50 hours, then as scheduled.
- Inspect new belt after first 50 hours, then as scheduled.
- Replace the hydraulic / hydrostatic filter element after the first 50 hours; thereafter when the transmission warning light comes ON while operating or as scheduled.
- Or every 12 months.

BOBCAT INTERLOCK CONTROL SYSTEM (BICS™)

Perform the procedures on flat level ground and make sure the area is clear of bystanders.

Inspecting The BICS™ (Engine STOPPED - Key ON)

Figure 86

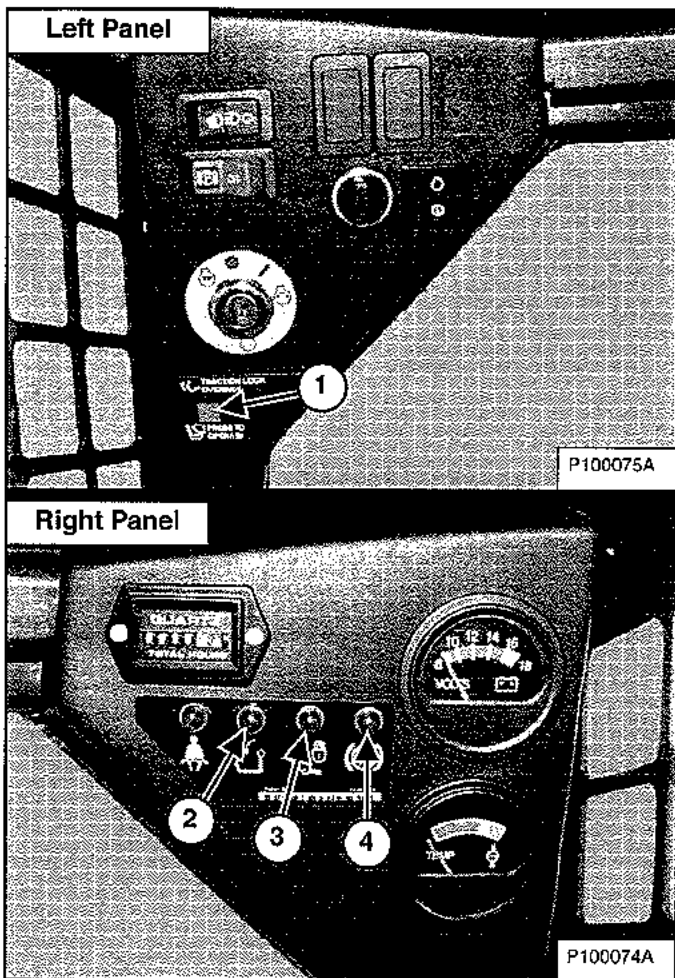

1. Sit in the operator's seat, fasten the seat belt, turn the key ON (Keyless Start Panel - enter the password / user code on the keypad), lower the seat bar and disengage the parking brake. Press the PRESS TO OPERATE LOADER button (Item 1). The three BICS™ lights (Items 2, 3 and 4) on the right instrument panel must be OFF (SEAT BAR, LIFT & TILT VALVE, and PARKING BRAKE) [Figure 86].
2. Raise the seat bar fully. The three BICS™ lights (Items 2, 3 and 4) [Figure 86] on the right instrument panel must be ON (SEAT BAR, LIFT & TILT VALVE, and PARKING BRAKE).

NOTE: Record what lights are blinking (if any) and the number of light flashes.

Inspecting The Seat Bar Sensor (Engine RUNNING)

3. Fasten the seat belt, lower the seat bar and make sure the parking brake is engaged.
4. Start the engine and operate at low idle. Press the PRESS TO OPERATE LOADER button. While raising the lift arms, raise the seat bar fully. The lift arms must stop. Repeat using the tilt function.

Inspecting The Traction Lock (Engine RUNNING)

5. Fasten seat belt, lower the seat bar, disengage the parking brake and press the PRESS TO OPERATE LOADER button. Raise the seat bar fully and move the steering levers slowly forward and backward. The traction drive system will be locked.
6. Fasten seat belt, lower the seat bar and press the PRESS TO OPERATE LOADER button. Engage the parking brake and move the steering levers slowly forward and backward. The traction drive system will be locked.

NOTE: The PARKING BRAKE light on the left instrument panel will remain ON until the engine is started, the PRESS TO OPERATE LOADER button is pressed and the parking brake is disengaged.

Inspecting The Lift Arm Bypass Control

7. Raise the lift arms 2 m (6 ft) off the ground. Stop the engine. Turn the lift arm bypass control knob clockwise 1/4 turn. Pull out and hold the knob until the lift arms slowly lower.

! WARNING

AVOID INJURY OR DEATH

The Bobcat Interlock Control System (BICS™) must deactivate the lift, tilt, traction drive and front auxiliary hydraulic functions. If it does not, contact your dealer for service. **DO NOT** modify the system.

W-2689-0813

BOBCAT INTERLOCK CONTROL SYSTEM (BICS™) (CONT'D)

Inspecting Deactivation Of The Auxiliary Hydraulics System

Perform the procedures on flat level ground and make sure the area is clear of bystanders.

Engine Starting

Figure 87

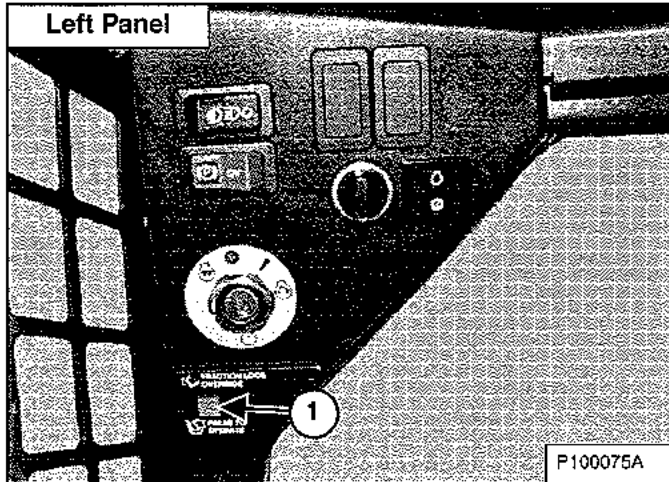

8. Install an attachment with hydraulic connections. (See Installing And Removing The Attachment on Page 55.) Perform the pre-starting procedure. (See PRE-STARTING PROCEDURE on Page 45.) Fasten the seat belt, lower the seat bar and make sure the parking brake is engaged. Start the engine. Move the Auxiliary Hydraulic Control Lever to the left or the right. (See Front Auxiliary Hydraulics Operation on Page 40.) There will not be hydraulic oil flow to the attachment.

Press the PRESS TO OPERATE LOADER button (Item 1) [Figure 87] and then engage the auxiliary hydraulics. The auxiliary hydraulic oil will flow to the attachment.

Engine Running

9. Install an attachment with hydraulic connections. (See Installing And Removing The Attachment on Page 55.) Perform the pre-starting procedure. (See PRE-STARTING PROCEDURE on Page 45.) Fasten the seat belt, lower the seat bar and make sure the parking brake is engaged. Start the engine. Press the PRESS TO OPERATE LOADER button (Item 1) [Figure 87]. Move the Auxiliary Hydraulic Control Lever to the left or the right. The auxiliary hydraulic oil will flow to the attachment. (See Front Auxiliary Hydraulics Operation on Page 40.) Raise the seat bar. The auxiliary hydraulic oil flow to the attachment will STOP.

! WARNING

AVOID INJURY OR DEATH

The Bobcat Interlock Control System (BICS™) must deactivate the lift, tilt, traction drive and front auxiliary hydraulic functions. If it does not, contact your dealer for service. **DO NOT** modify the system.

W-2689-0813

SEAT BAR RESTRAINT SYSTEM

Description

The seat bar restraint system has a pivoting seat bar with armrests.

The operator controls the use of the seat bar. The seat bar in the down position helps to keep the operator in the seat.

The foot pedals have mechanical interlocks for the lift and tilt functions. The mechanical interlocks require the operator to lower the seat bar in order to operate the foot pedal controls.

When the seat bar is down, the PRESS TO OPERATE LOADER button is activated and the engine is running, the lift, tilt and traction drive functions can be operated.

When the seat bar is up, the lift and tilt control pedals are locked when returned to the NEUTRAL position.

Inspecting

Sit in the seat and fasten the seat belt. Engage the parking brake. Pull the seat bar all the way down. Start the engine. Press the PRESS TO OPERATE LOADER button.

Operate the hydraulic controls to check that both the lift and tilt functions operate correctly. Raise the lift arms until the attachment is about 600 mm (2 ft) off the ground.

Raise the seat bar. Move the hydraulic controls. Pedals must be firmly locked in the NEUTRAL position. There must be no motion of the lift arms or tilt (attachment) when the controls are moved.

Lower the seat bar, press the PRESS TO OPERATE LOADER button, lower the lift arms. Operate the lift control. While the lift arms are going up, raise the seat bar. The lift arms must stop.

Lower the seat bar, press the PRESS TO OPERATE LOADER button, lower the lift arms and put the attachment flat on the ground. Stop the engine. Raise the seat bar. Operate the foot pedals to be sure they are firmly locked in the NEUTRAL position.

WARNING

The seat bar system must deactivate the lift and tilt control functions when the seat bar is up. See your Bobcat dealer for service if hydraulic controls do not deactivate.

W-2465-0111

Maintaining

See the service schedule for correct service interval. (See SERVICE SCHEDULE on Page 71.)

Figure 88

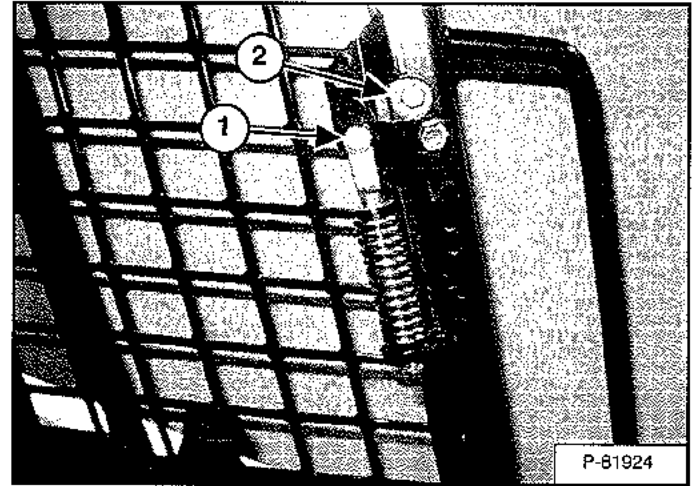
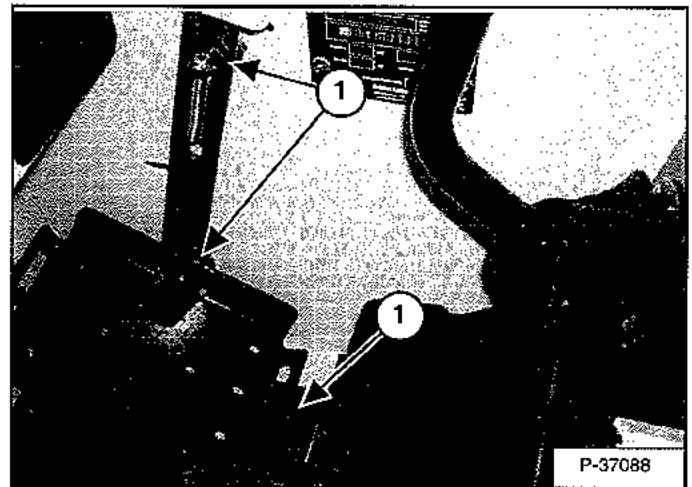

Figure 89



Use compressed air to clean any debris or dirt from the pivot parts (Item 1) [Figure 88] and [Figure 89]. Do not lubricate. Inspect all mounting hardware. The correct bolt torque is 34 - 38 N•m (25 - 28 ft-lb) for the seat bar pivot (Item 2) [Figure 88].

If the seat bar system does not function correctly, check for free movement of each linkage part. Check for excessive wear. Adjust pedal control linkage. Replace parts that are worn or damaged. Use only genuine Bobcat replacement parts.

SEAT BELT

Inspection And Maintenance

! WARNING

Failure to properly inspect and maintain the seat belt can cause lack of operator restraint resulting in serious injury or death.

W-2466-0703

Check the seat belt daily for correct function.

Inspect the seat belt system thoroughly yearly or more often if the machine is exposed to severe environmental conditions or applications.

The seat belt system should be repaired or replaced if it shows cuts, fraying, extreme or unusual wear, significant discolorations due to ultraviolet (UV) rays from the sun, dusty/dirty conditions, abrasion to the seat belt webbing, or damage to the buckle, latch plate, retractor (if equipped), or hardware.

The items below are referenced in [Figure 90].

1. Check the seat belt webbing. If the system is equipped with a retractor, pull the webbing completely out and inspect the full length of the webbing. Look for cuts, wear, fraying, dirt and stiffness.
2. Check the buckle and latch for proper function. Make sure latch plate is not excessively worn, deformed or buckle is not damaged.
3. Check the retractor web storage device (if equipped) by extending the seat belt webbing to determine if it extends and retracts the webbing correctly.
4. Check webbing in areas exposed to ultraviolet (UV) rays from the sun or extreme dust or dirt. If the original color of the webbing in these areas is extremely faded and / or the webbing is packed with dirt, the webbing strength may have weakened.

See your Bobcat dealer for approved seat belt system replacement parts for your machine.

Figure 90

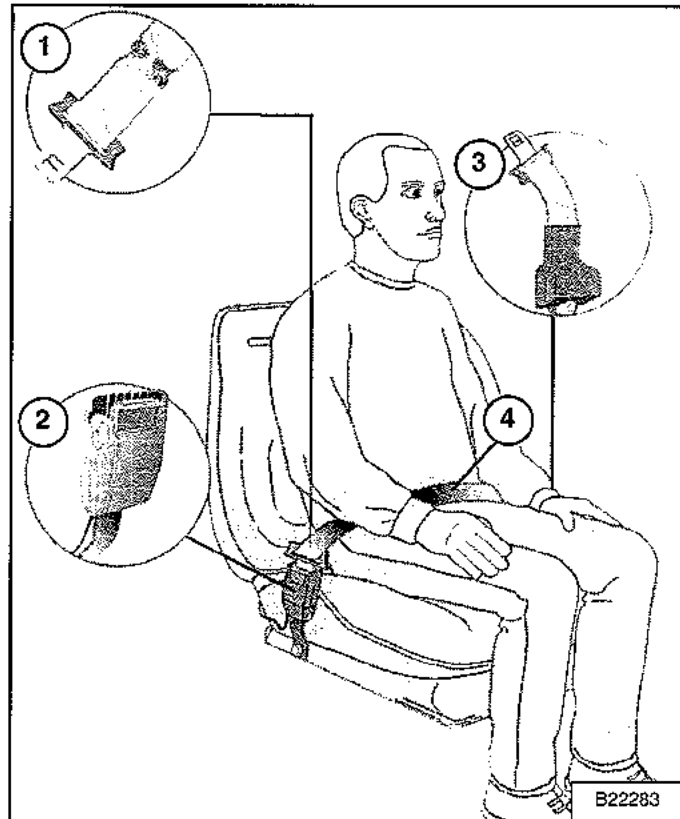

LIFT ARM SUPPORT DEVICE

Installing

Maintenance and service work can be done with the lift arms lowered. If the lift arms are raised, use the following procedures to engage and disengage an approved lift arm support device.

! WARNING

Never work on a machine with the lift arms up unless the lift arms are secured by an approved lift arm support device. Failure to use an approved lift arm support device can allow the lift arms or attachment to fall and cause injury or death.

Service lift arm support device if damaged or if parts are missing. Using a damaged lift arm support or with missing parts can cause lift arms to drop causing injury or death.

W-2572-0407

! DANGER

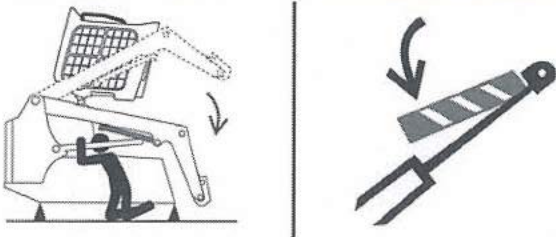

P-90328

AVOID DEATH

- Disconnecting or loosening any hydraulic tubeline, hose, fitting, component or a part failure can cause lift arms to drop.
- Keep out of this area when lift arms are raised unless supported by an approved lift arm support. Replace if damaged.

D-1009-0409

Remove the attachment from the loader. (See Installing And Removing The Attachment on Page 55.)

! WARNING

Before the cab or the lift arms are raised for service, jackstands must be put under the rear corners of the frame. Failure to use jackstands can allow the machine to tip backward causing injury or death.

W-2014-0895

Figure 91

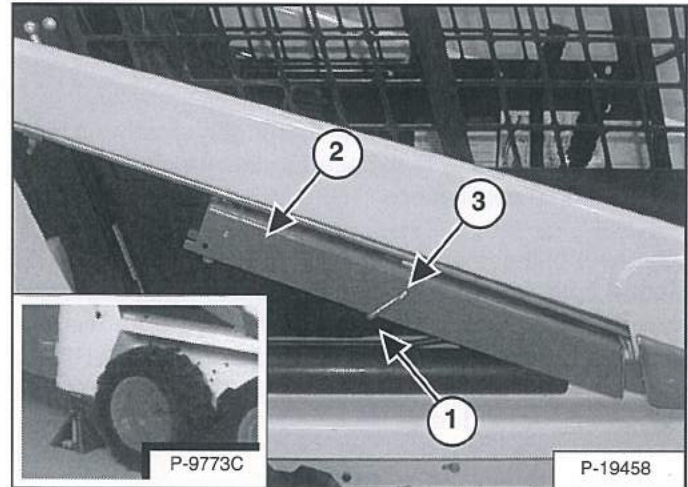

Put jackstands under the rear corners of the loader frame (Inset) [Figure 91].

Disconnect the spring (Item 1) from the lift arm support device retaining pin, Support the lift arm support device (Item 2) with your hand and remove the retaining pin (Item 3) [Figure 91].

Figure 92

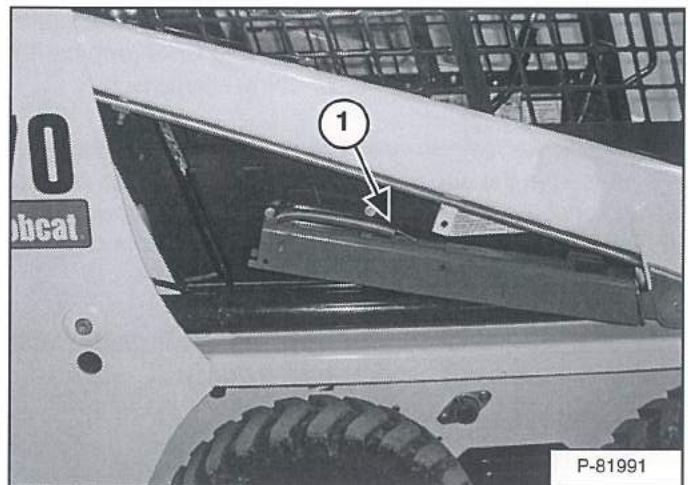

Lower the lift arm support device to the top of the lift cylinder. Hook the free end of the spring (Item 1) [Figure 92] to the lift arms support device so there will be no interference with the support device engagement.

LIFT ARM SUPPORT DEVICE (CONT'D)

Installing (Cont'd)

With the operator in the seat, seat belt fastened and seat bar lowered, start the engine, press the PRESS TO OPERATE LOADER button.

Figure 93

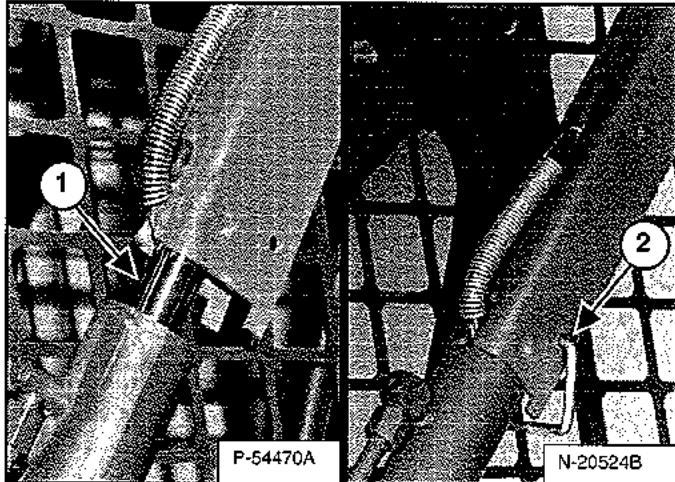

Raise the lift arms until the lift arm support device drops onto the lift cylinder rod (Item 1) [Figure 93].

Lower the lift arms slowly until the support device is held between the lift arm and the lift cylinder.

Stop the engine. Raise the seat bar and move both pedals until both pedals lock.

Install pin (Item 2) [Figure 93] into the rear of the lift arm support device below the cylinder rod.

Removing

Figure 94

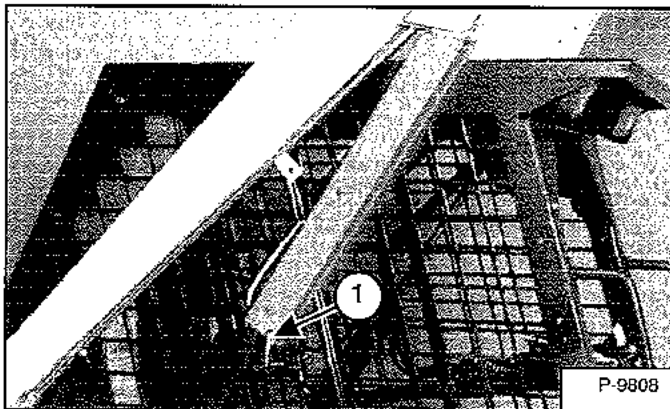

Remove the retaining pin (Item 1) [Figure 94] from the lift arm support device.

Figure 95

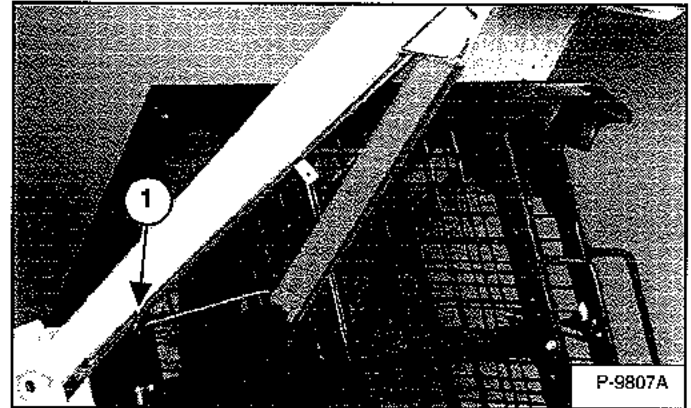

Connect the spring from the lift arm support device to the tubeline bracket (Item 1) [Figure 95] on the lift arms.

With the operator in the seat, seat belt fastened and seat bar lowered, start the engine, press the PRESS TO OPERATE LOADER button.

Raise the lift arms a small amount. The spring will lift the support device off the lift cylinder rod.

Lower the lift arms and stop the engine.

Raise the seat bar, disconnect the seat belt and move the pedals until both pedals lock.

Disconnect the spring from the bracket.

Figure 96

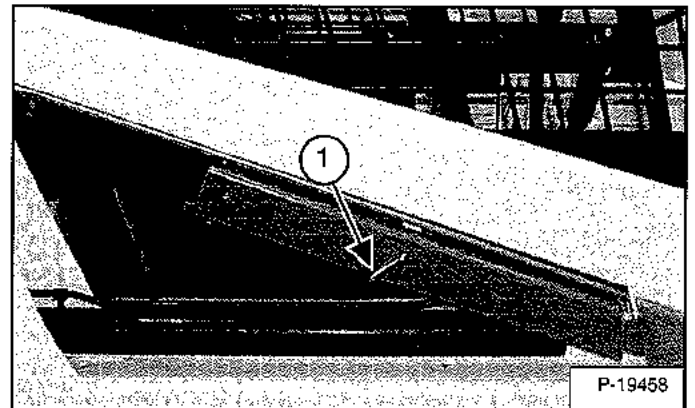

Raise the support device into storage position and insert the pin through the lift arm support device and bracket (Item 1) [Figure 96].

Connect the spring to the pin [Figure 96]

Remove the jackstands.

BACK-UP ALARM SYSTEM

Description

The back-up alarm will sound when the operator moves both steering levers into the reverse position. Slight movement of the steering levers into the reverse position is required with hydrostatic transmissions, before the back-up alarm will sound.

Inspecting

Figure 97

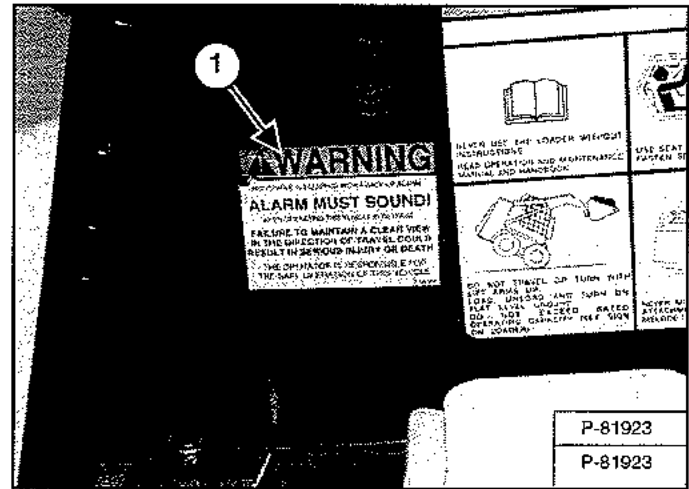

Inspect for damaged or missing back-up alarm decal (Item 1) [Figure 97]. Replace if required.

Sit in the seat and fasten the seat belt. Engage the parking brake. Pull the seat bar all the way down. Start the engine. Press the PRESS TO OPERATE LOADER button. Disengage the parking brake.

Move both steering levers into the reverse position. The back-up alarm must sound when all wheels are moving in reverse.

The back-up alarm is located on the inside of the rear door.

Figure 98

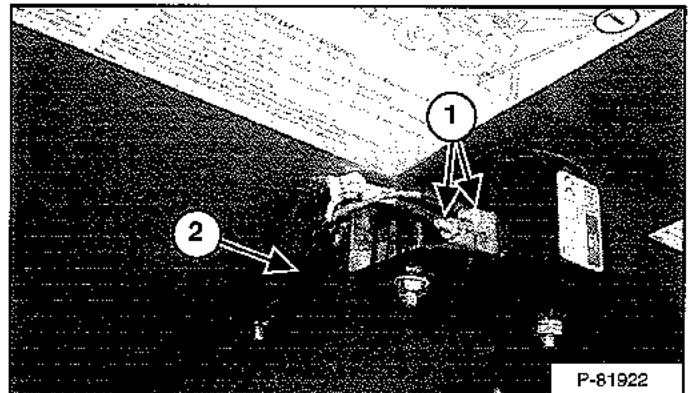

Inspect the back-up alarm electrical connections (Item 1) [Figure 98], wire harness (Item 2) [Figure 98] and back-up alarm switches (Item 1) [Figure 99] or [Figure 100] for tightness and damage. Repair or replace any damaged components.

If the back-up alarm switches require adjustment, (See Adjusting Switch Position on Page 79.)

BACK-UP ALARM SYSTEM (CONT'D)

Adjusting Switch Position

Stop the engine and exit the loader. (See STOPPING THE ENGINE AND LEAVING THE LOADER on Page 53.)

Raise the operator cab. (See OPERATOR CAB on Page 80.)

Earlier Models

Place the steering levers in the neutral position.

Figure 99

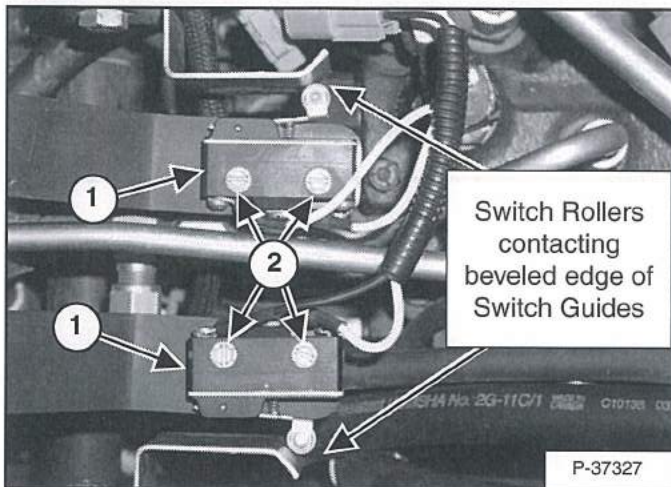

Loosen the screws (Item 2) securing the back-up alarm switches (Item 1) [Figure 99].

Position the back-up alarm switch rollers so that they just make contact with the beveled edge of the switch guides without compressing the switch springs. Torque the screws (Item 2) [Figure 99] securing the switches to the bracket to 1,6 - 2,1 N•m (14 - 19 in-lb).

Later Models

Figure 100

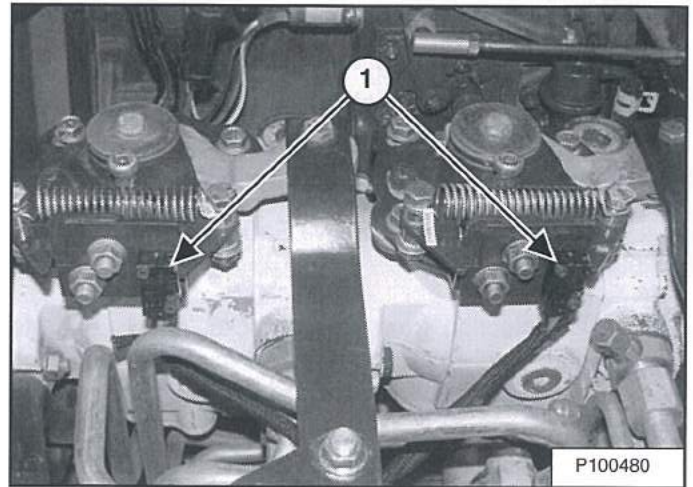

The back-up alarm switches (Item 1) [Figure 100] are located on the hydrostatic pump controls.

NOTE: The back-up alarm switches on later model loaders do not require adjustment. See your Bobcat dealer for service if your back-up alarm does not sound.

All Models

Lower the operator cab. (See Lowering on Page 81.)

Inspect back-up alarm system for proper function. (See Inspecting on Page 78.)

OPERATOR CAB

Description

The Bobcat Loader has an operator cab (ROPS and FOPS) as standard equipment to protect the operator from rollover and falling objects. The seat belt must be worn for rollover protection.

Check the cab, mounting, and hardware for damage. Never modify the cab. Replace the cab and hardware if damaged. See your Bobcat dealer for parts.

ROPS - Roll-Over Protective Structure per ISO 3471 and FOPS - Falling-Object Protective Structure per ISO 3449, Level I.

Level I - Protection from falling bricks, small concrete blocks, and hand tools encountered in operations such as highway maintenance, landscaping, and other construction sites.

WARNING

Never modify operator cab by welding, grinding, drilling holes or adding attachments unless instructed to do so by Bobcat Company. Changes to the cab can cause loss of operator protection from rollover and falling objects, and result in injury or death.

W-2069-0200

DANGER

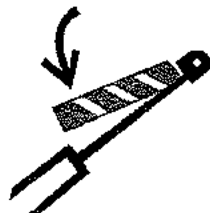
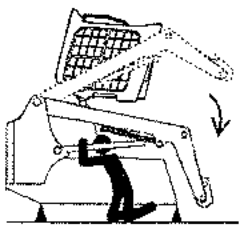

P-90328

AVOID DEATH

- Disconnecting or loosening any hydraulic tubeline, hose, fitting, component or a part failure can cause lift arms to drop.
- Keep out of this area when lift arms are raised unless supported by an approved lift arm support. Replace if damaged.

D-1009-0409

Raising

Always stop the engine before raising or lowering the cab.

Stop the loader on a level surface and lower the lift arms. If the lift arms must be up while raising the operator cab, install the lift arm support device. (See LIFT ARM SUPPORT DEVICE on Page 76.)

WARNING

Before the cab or the lift arms are raised for service, jackstands must be put under the rear corners of the frame. Failure to use jackstands can allow the machine to tip backward causing injury or death.

W-2014-0895

OPERATOR CAB (CONT'D)

Raising (Cont'd)

Figure 101

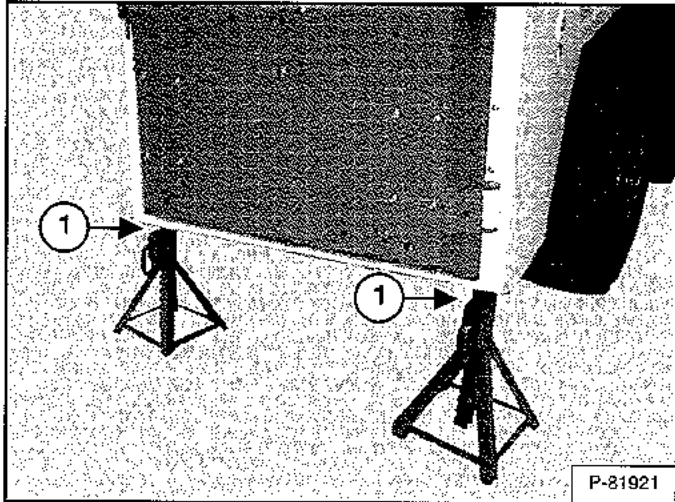

Install jackstands (Item 1) [Figure 101] under the rear corners of the loader frame.

Figure 102

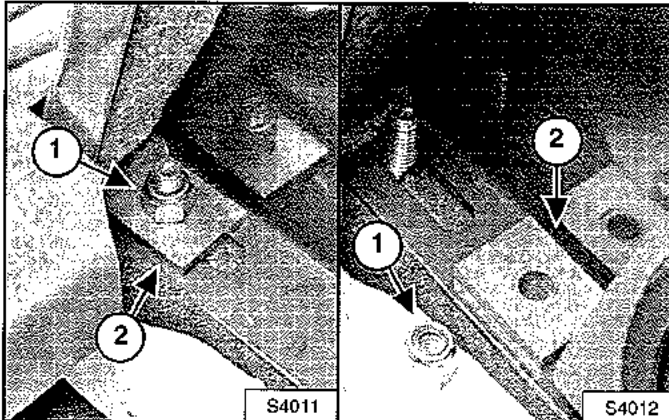

Remove the nut and plate (Items 1 and 2) [Figure 102] on the inside front corner of the cab (both sides).

Figure 103



Lift on the grab handle and bottom of the operator cab slowly until the cab is all the way up and the latching mechanism engages [Figure 103].

Lowering



AVOID INJURY OR DEATH

The cab must be held to prevent falling while hand is in access hole.

W-2205-1207

Always stop the engine before raising or lowering the cab.

Figure 104

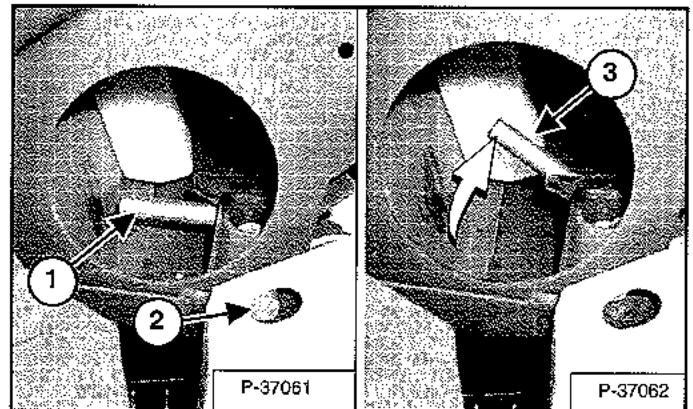

Hold the operator cab. Release the locking mechanism by pushing the lever (Item 1) in from the locked position (Item 2) and turning the lever until it stays in the unlocked position (Item 3) [Figure 104].

OPERATOR CAB (CONT'D)

Lowering (Cont'd)

REMOVE YOUR HAND FROM THE HOLE BEFORE LOWERING THE OPERATOR CAB.

Stand on the ground and pull the cab down. Avoid slippery surfaces. Use both hands to lower the cab all the way down.

NOTE: The weight of the cab increases when equipped with options and accessories such as cab door, heater, etc. In these cases, the cab may need to be raised slightly from the latch to be able to release the latch.

NOTE: Always use the grab handles (once you can reach them) to lower the cab.

Figure 105

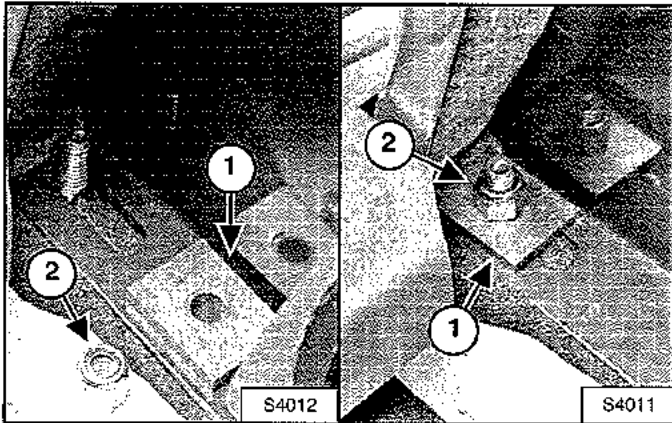

Install the plates and nuts (Items 1 and 2) [Figure 105] (both sides).

Tighten the nuts to 54 - 61 N•m (40 - 45 ft-lb) torque.

If Equipped With A Heater, Do The Following:

Earlier Model Heater

NOTE: The heater hose connectors will disconnect when the cab is raised. The heater hose connectors must be reconnected for the heater to work after the cab is lowered and secured.

Move the seat as far forward as needed to access the heater hose connectors that are located at the rear of the cab.

Figure 106

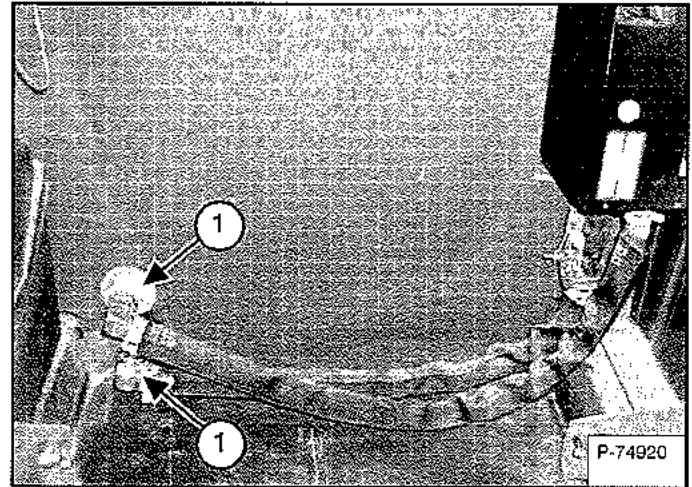

From behind the operator's seat, push the two heater quick connectors (Item 1) [Figure 106] into the heater couplers.

Later Model Heater

The heater hoses are routed through the rear wall of the cab behind the heater and will remain connected while raising and lowering the cab.

REAR DOOR (TAILGATE)

Opening And Closing

WARNING

AVOID INJURY OR DEATH

Never service or adjust the machine when the engine is running unless instructed to do so in the manual.

W-2012-0497

Figure 107

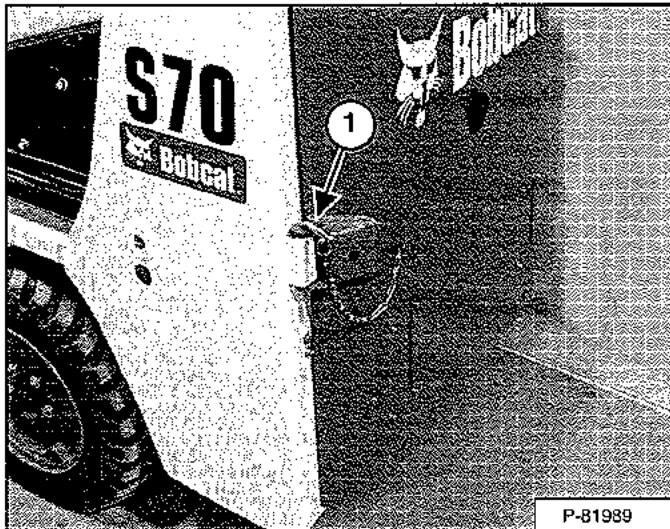

Remove the latch pin (Item 1) [Figure 107] and pull the rear door open.

Open the rear door for engine service.

WARNING

Keep the rear door closed when operating the machine. Failure to do so could seriously injure a bystander.

W-2020-1285

Close the rear door before operating the loader.

AIR CLEANER SERVICE

Replacing Filter Elements

Figure 108

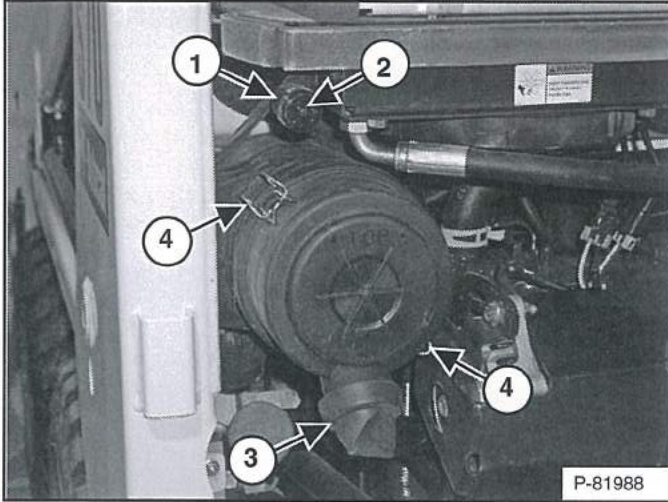

Replace the large (outer) filter element only when the red ring shows in the window of the condition indicator (Item 1) [Figure 108].

NOTE: Before replacing the filter element, push the button on the condition indicator (Item 2) [Figure 108]. Start the engine. If the red ring does not show, do not replace the filter element.

Outer Filter

Open the evacuator valve (Item 3) [Figure 108] to get rid of large particles of dust and dirt.

Remove the dust cover by lifting the latches (Item 4) [Figure 108].

Figure 109

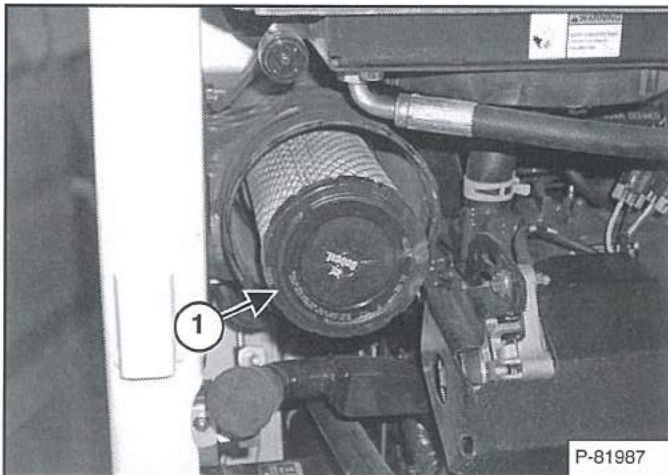

Pull the element straight out (Item 1) [Figure 109].

Install a new outer element.

Install the dust cover [Figure 108].

Check the air intake hose and the air cleaner housing for damage. Make sure all connections are tight.

Inner Filter

Replace the inner filter every third time the outer filter is replaced or when the red ring still shows in the indicator window after the outer filter has been replaced.

Figure 110

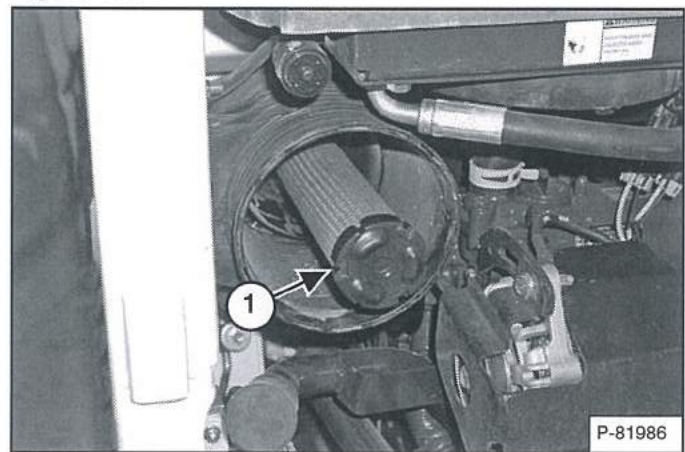

Remove the inner filter (Item 1) [Figure 110].

NOTE: Make sure all sealing surfaces are free of dirt and debris.

Install a new inner element.

Install the outer element.

Install the dust cover [Figure 108].

FUEL SYSTEM

Fuel Specifications

Use only clean, high quality diesel fuel, Grade No. 2 or Grade No. 1.

The following is one suggested blending guideline which should prevent fuel gelling during cold temperatures:

TEMPERATURE C° (F°)	NO. 2	NO. 1
-9° (+15°)	100%	0%
Down to -29° (-20°)	50%	50%
Below -29° (-20°)	0%	100%

At a minimum, low sulfur diesel fuel must be used in this machine. Low sulfur is defined as 500 mg/kg (500 ppm) sulfur maximum.

The following fuels may also be used in this machine:

- Ultra low sulfur diesel fuel. Ultra low sulfur is defined as 15 mg/kg (15 ppm) sulfur maximum.
- Biodiesel blend fuel - Must contain no more than five percent biodiesel mixed with low sulfur or ultra low sulfur petroleum based diesel. This is commonly marketed as B5 blended diesel fuel. B5 blended diesel fuel must meet ASTM D975 (US Standard) or EN590 (EU Standard) specifications.

Biodiesel Blend Fuel

Biodiesel blend fuel has unique qualities that should be considered before using in this machine:

- Cold weather conditions can lead to plugged fuel system components and hard starting.
- Biodiesel blend fuel is an excellent medium for microbial growth and contamination which can cause corrosion and plugging of fuel system components.
- Use of biodiesel blend fuel may result in premature failure of fuel system components, such as plugged fuel filters and deteriorated fuel lines.
- Shorter maintenance intervals may be required, such as cleaning the fuel system and replacing fuel filters and fuel lines.
- Using biodiesel blended fuels containing more than five percent biodiesel can affect engine life and cause deterioration of hoses, tubelines, injectors, injector pump and seals.

Apply the following guidelines if biodiesel blend fuel is used:

- Ensure the fuel tank is as full as possible at all times to prevent moisture from collecting in the fuel tank.
- Ensure that the fuel tank cap is securely tightened.
- Biodiesel blend fuel can damage painted surfaces, remove all spilled fuel from painted surfaces immediately.
- Drain all water from the fuel filter daily before operating the machine.
- Do not exceed engine oil change interval. Extended oil change intervals can cause engine damage.
- Before vehicle storage; drain the fuel tank, refill with 100% petroleum diesel fuel, add fuel stabilizer and run the engine for at least 30 minutes.

NOTE: Biodiesel blend fuel does not have long term stability and should not be stored for more than three months.

FUEL SYSTEM (CONT'D)

Filling The Fuel Tank

! WARNING

AVOID INJURY OR DEATH

Stop and cool the engine before adding fuel. **NO SMOKING!** Failure to obey warnings can cause an explosion or fire.

W-2063-0807

Figure 111

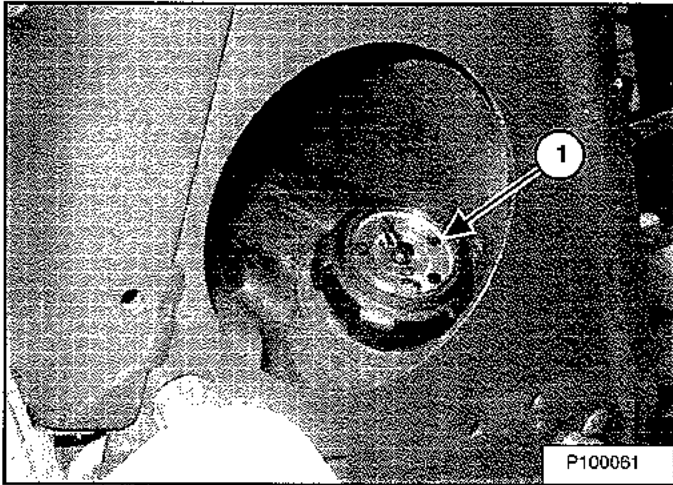

The fuel gauge (Item 1) [Figure 111] is located on the right side of the loader.

Figure 112

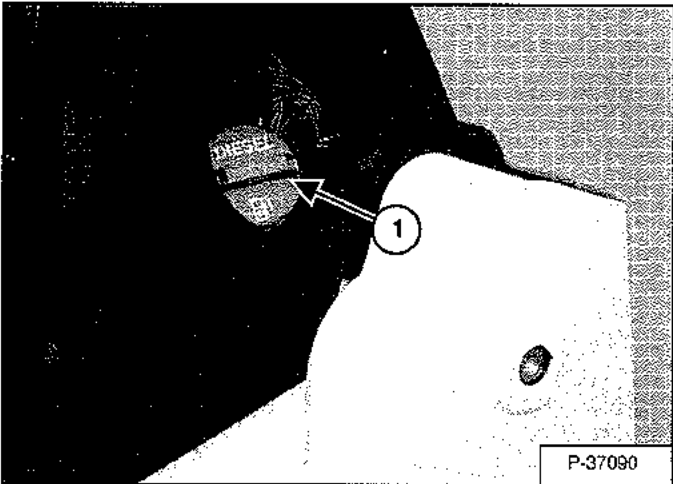

Remove the fill cap (Item 1) [Figure 112].

Figure 113

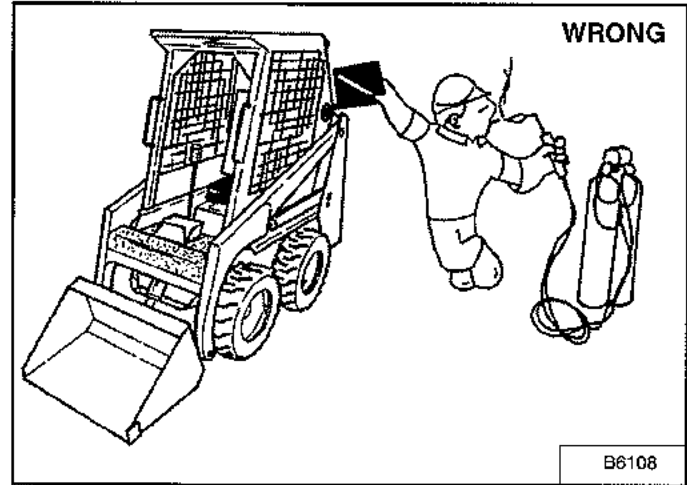

Use a clean, approved safety container to add fuel of the correct specification. Add fuel only in an area that has free movement of air and no open flames or sparks. **NO SMOKING!** [Figure 113].

Install and tighten the fuel fill cap (Item 1) [Figure 112].

! WARNING

AVOID INJURY OR DEATH

Always clean up spilled fuel or oil. Keep heat, flames, sparks or lighted tobacco away from fuel and oil. Failure to use care around combustibles can cause explosion or fire.

W-2103-0508

FUEL SYSTEM (CONT'D)

Fuel Filter

For the service interval for removing water from, or replacing the fuel filter (See SERVICE SCHEDULE on Page 71.)

Removing Water

Figure 114

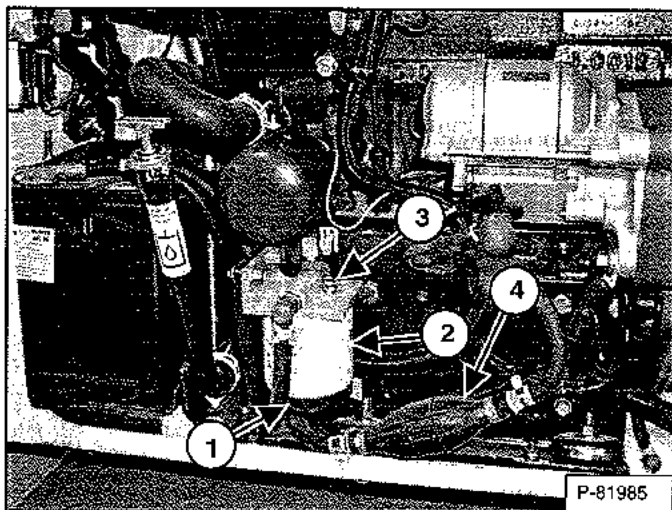

Loosen the drain (Item 1) [Figure 114] at the bottom of the filter element to remove water from the filter.

Replacing Element

Remove the filter element (Item 2) [Figure 114].

Clean the area around the filter housing. Put clean oil on the seal of the new filter element. Install the fuel filter, and hand tighten.

Remove air from the fuel system. (See Removing Air From The Fuel System below.)

Removing Air From The Fuel System

After replacing the filter element or when the fuel tank has run out of fuel, the air must be removed from the fuel system before starting the engine.

Open the vent (Item 3) [Figure 114] on the fuel filter housing.

WARNING

AVOID INJURY OR DEATH

Diesel fuel or hydraulic fluid under pressure can penetrate skin or eyes, causing serious injury or death. Fluid leaks under pressure may not be visible. Use a piece of cardboard or wood to find leaks. Do not use your bare hand. Wear safety goggles. If fluid enters skin or eyes, get immediate medical attention from a physician familiar with this injury.

W-2072-0807

Squeeze the hand pump (priming bulb) (Item 4) [Figure 114] until there are no air bubbles exiting the vent.

Close the vent (Item 3) [Figure 114] on the fuel filter housing.

With the operator in the seat, seat belt fastened, seat bar lowered and parking brake engaged, start the engine.

NOTE: If the engine fails to start, remove air from the fuel injection pump as follows.

Put jackstands under rear of the frame and raise operator cab. (See Raising on Page 80.)

Figure 115

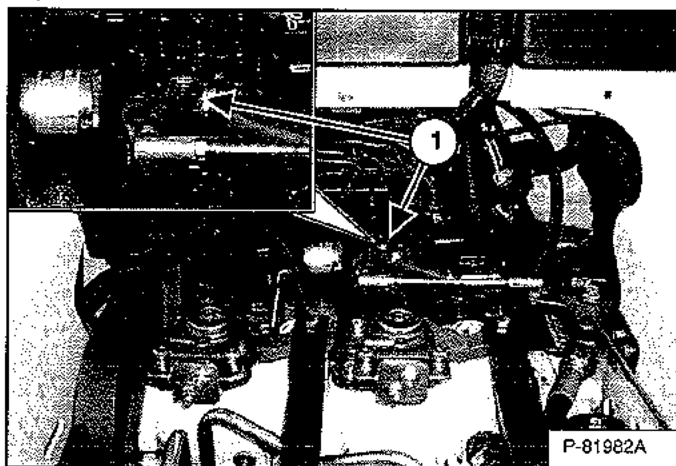

Open the valve (Item 1) [Figure 115] on the injector pump and squeeze the hand pump (Item 4) [Figure 114] several times until fuel comes from the valve.

Close the valve.

Lower the operator cab. (See Lowering on Page 81.)

Remove jackstands.

ENGINE LUBRICATION SYSTEM

Checking And Adding Engine Oil

Check the engine oil level every day before starting the engine for the work shift.

Figure 116

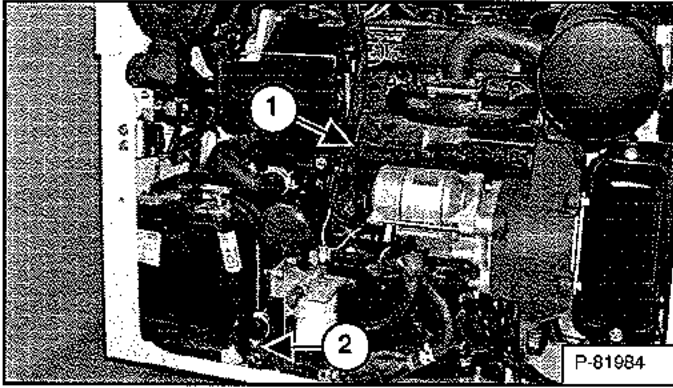

Park the machine on level ground. Open the rear door and remove the dipstick (Item 1) [Figure 116]. Keep the oil level between the marks on the dipstick. Do not overfill.

Engine Oil Chart

Figure 117

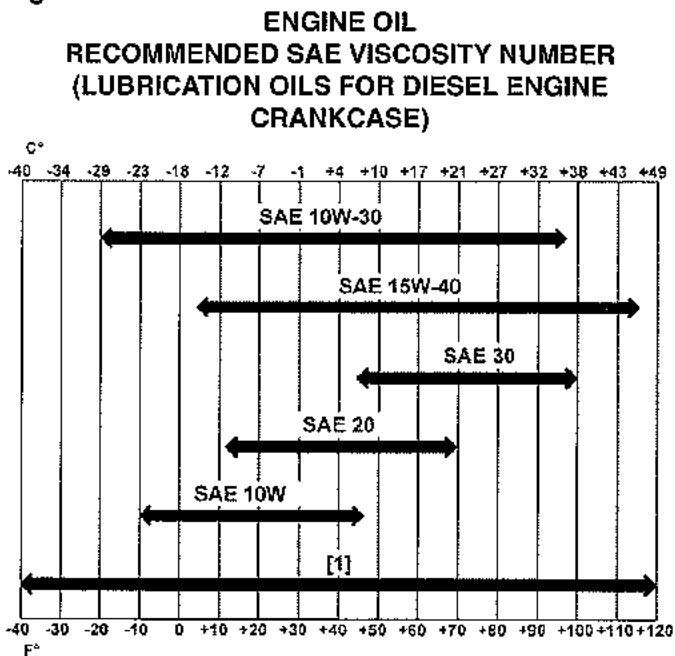

**TEMPERATURE RANGE ANTICIPATED BEFORE
NEXT OIL CHANGE (DIESEL ENGINES MUST USE API
CLASSIFICATION CI-4 OR BETTER)**

[1] Synthetic Oil - Use recommendation from Synthetic Oil Manufacturer.

Use good quality engine oil that meets API Service Classification of CI-4 or better [Figure 117].

Removing And Replacing Oil And Filter

For the service interval for replacing the engine oil and filter (See SERVICE SCHEDULE on Page 71.)

Run the engine until it is at operating temperature. Stop the engine.

Open the rear door and remove the drain hose (Item 2) [Figure 116] from its storage position.

Figure 118

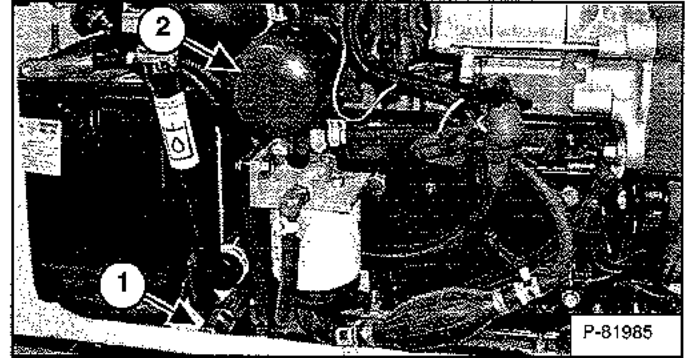

Remove the oil drain cap (Item 1) [Figure 118] and drain the oil into a container. Recycle or dispose of used oil in an environmentally safe manner.

Remove the oil filter (Item 2) [Figure 118] and clean the filter housing surface.

Use genuine Bobcat filter only. Put oil on the new filter gasket, install the filter and hand tighten.

Install and tighten the oil drain cap and return the drain hose to the stored position.

Remove the fill cap and put oil in the engine. For the correct quantity (See Capacities on Page 132.) Do not overfill.

Start the engine and let it run for several minutes. Stop the engine and check for leaks at the filter.

Add oil as needed if it is not at the top mark on the dipstick. Install the dipstick and close the rear door.

! WARNING

AVOID INJURY OR DEATH

Always clean up spilled fuel or oil. Keep heat, flames, sparks or lighted tobacco away from fuel and oil. Failure to use care around combustibles can cause explosion or fire.

W-2103-0508

ENGINE COOLING SYSTEM

Check the cooling system every day to prevent over-heating, loss of performance or engine damage.

Cleaning

Open the rear door.

Figure 119

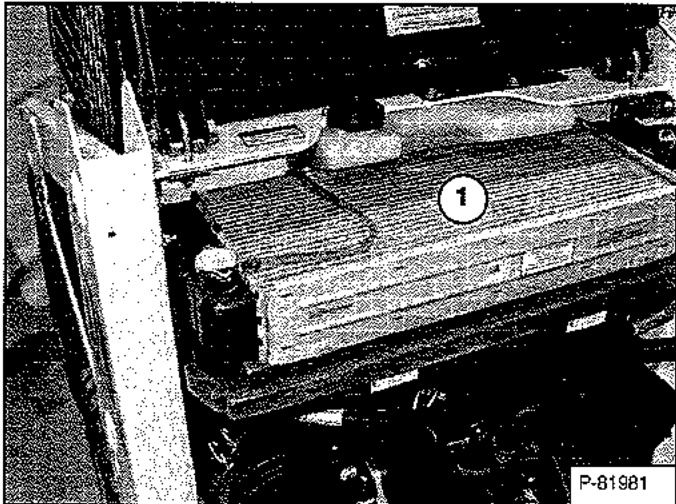

Use low air pressure or water pressure to clean the top of the radiator (Item 1) [Figure 119].

Check the cooling system for leaks.

Close the rear door.

Checking Level

Open the rear door.

WARNING

AVOID INJURY OR DEATH

Wear safety glasses to prevent eye injury when any of the following conditions exist:

- When fluids are under pressure.
- Flying debris or loose material is present.
- Engine is running.
- Tools are being used.

W-2019-0907

Figure 120

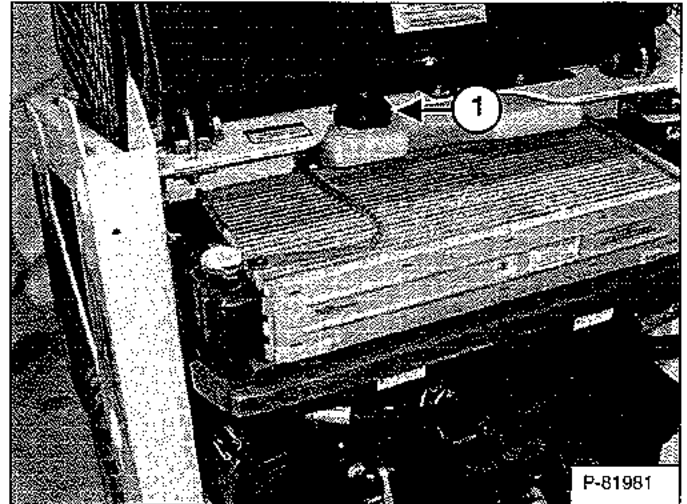

Remove the coolant fill cap (Item 1) [Figure 120]. Check the coolant level. The level markers are on the tank. Coolant must be at the bottom marker when the engine is cold and on the top marker when hot.

Use a refractometer to check the condition of propylene glycol in your cooling system.

Close the rear door before operating the loader.

IMPORTANT

AVOID ENGINE DAMAGE

Always use the correct ratio of water to antifreeze.

Too much antifreeze reduces cooling system efficiency and may cause serious premature engine damage.

Too little antifreeze reduces the additives which protect the internal engine components; reduces the boiling point and freeze protection of the system.

Always add a premixed solution. Adding full strength concentrated coolant can cause serious premature engine damage.

I-2124-0497

ENGINE COOLING SYSTEM (CONT'D)

Removing And Replacing Coolant

Open the rear door.

Figure 121

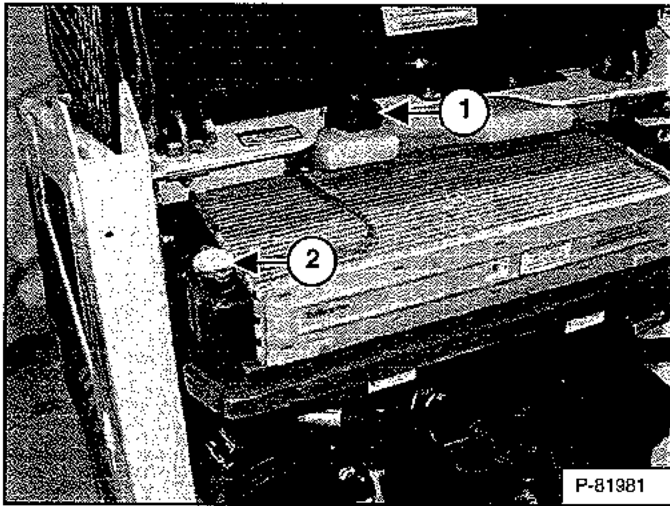

Remove the coolant fill cap (Item 1) [Figure 121].

Figure 122

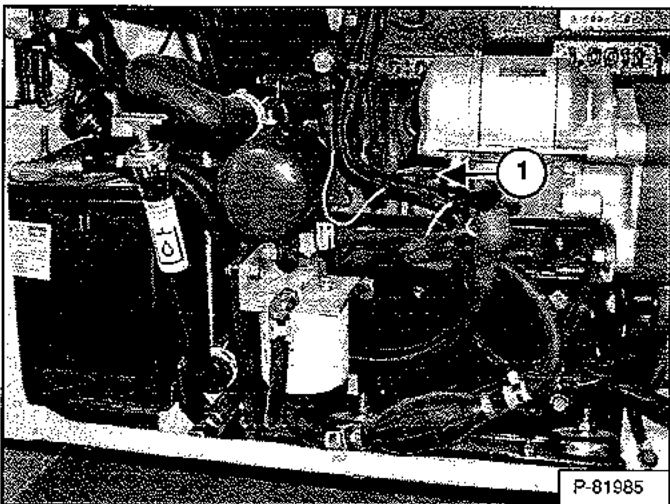

Connect a hose to the engine block drain valve (Item 1) [Figure 122] (located below the starter). Open the drain valve and drain the coolant into a container.

After all the coolant is removed, close the drain valve and remove the hose.

NOTE: Fluids such as engine oil, hydraulic fluid, coolant, etc. must be disposed of in an environmentally safe manner. Some regulations require that certain spills and leaks on the ground must be cleaned in a specific manner. See local, state and federal regulations for correct disposal.

Mix new coolant in a separate container. (See Capacities on Page 132.)

NOTE: The loader is factory filled with propylene glycol coolant (purple color). **DO NOT** mix propylene glycol with ethylene glycol.

Remove the radiator cap (Item 2) [Figure 121] and fill the radiator with premixed coolant, 47% water and 53% propylene glycol. Reinstall the radiator cap.

The correct mixture of coolant to provide a -37°C (-34°F) freeze protection is 5 L propylene glycol mixed with 4,4 L of water **OR** 1 U.S. gal propylene glycol mixed with 3.5 qt of water.

Fill the recovery tank with premixed coolant until it is at the lower marker on the tank.

Use a refractometer to check the condition of propylene glycol in your cooling system and replace the coolant fill cap (Item 1) [Figure 121].

Run the engine until it is at operating temperature. After stopping the engine, let it cool down and check the coolant level again. Add coolant as needed.

Close the rear door.

IMPORTANT

AVOID ENGINE DAMAGE

Always use the correct ratio of water to antifreeze.

Too much antifreeze reduces cooling system efficiency and may cause serious premature engine damage.

Too little antifreeze reduces the additives which protect the internal engine components; reduces the boiling point and freeze protection of the system.

Always add a premixed solution. Adding full strength concentrated coolant can cause serious premature engine damage.

I-2124-0497

ELECTRICAL SYSTEM

Description

The loader has a 12 volt, negative ground alternator charging system. The electrical system is protected by fuses located in the engine compartment. The fuses will protect the electrical system when there is an electrical overload. The reason for the overload must be found before starting the engine again.

Fuse And Relay Location / Identification

Figure 123

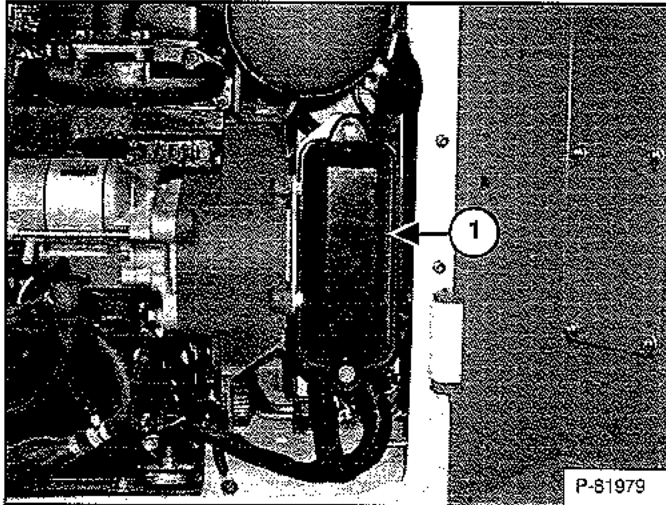

The electrical system is protected from overload by fuses and relays under the fuse panel cover (Item 1) [Figure 123]. A decal is inside the cover to show location and amperage ratings.

Figure 124

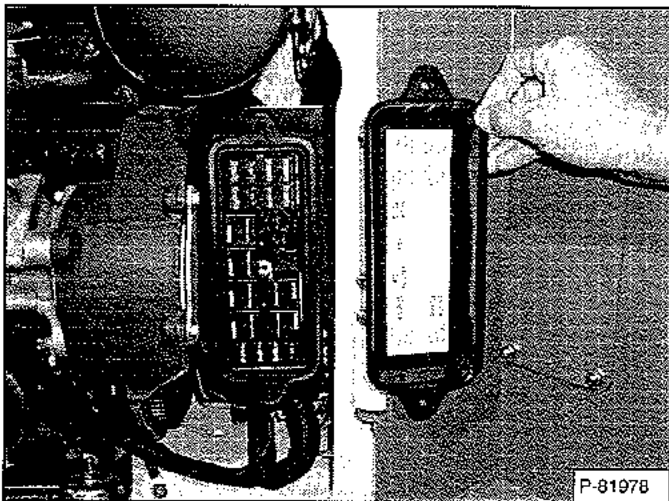

Remove the cover to check or replace the fuses [Figure 124].

Figure 125

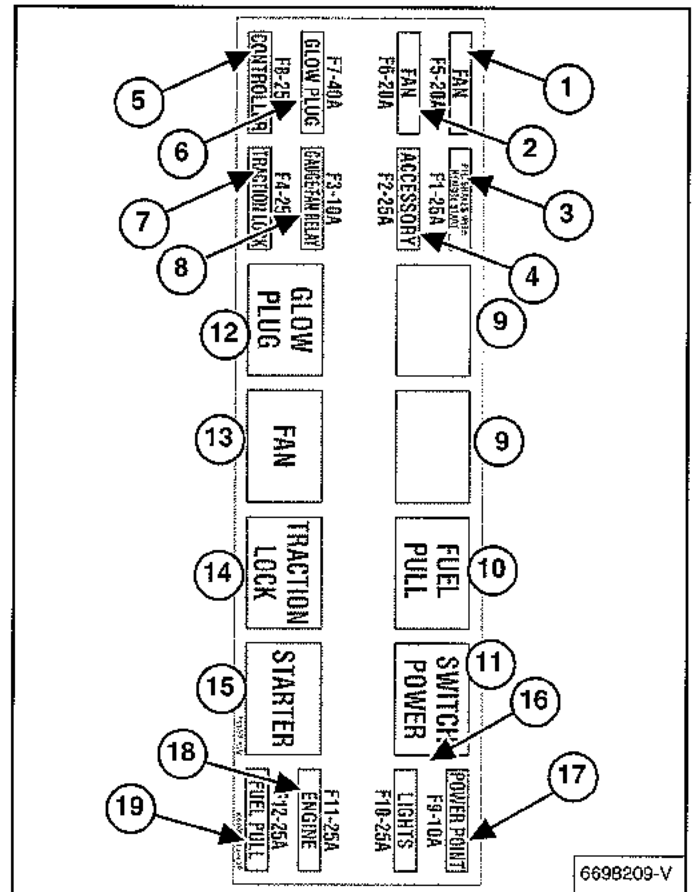

There is a decal [Figure 125] inside the fuse panel cover which shows location and size of fuses. Description and amperage ratings (or relays) are also shown below.

REF.	DESCRIPTION	AMPS	REF.	DESCRIPTION	AMPS
1	Fan	20	10	Fuel Solenoid	R
2	Fan	20	11	Switched Power	R
3	BICS / Brakes / Remote Start	25	12	Glow Plug	R
4	Accessory Back-up Alarm	25	13	Fan	R
5	Controller	25	14	Traction Lock	R
6	Glow Plug	40	15	Starter	R
7	Traction Lock	25	16	Lights	25
8	Gauge / Fan Relay	10	17	Power Point	10
9	Not Used	R	18	Engine / Horn	25
			19	Fuel Solenoid	25

R = Relay

ELECTRICAL SYSTEM (CONT'D)

Battery Maintenance

Figure 126

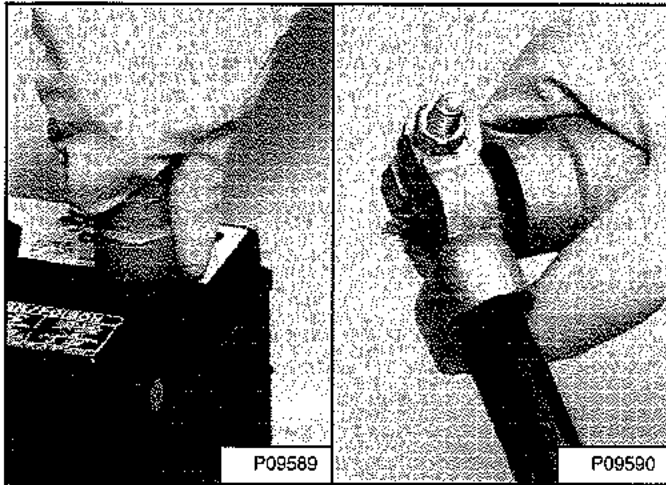

The battery cables must be clean and tight [Figure 126]. Check electrolyte level in the battery. Add distilled water as needed. Remove acid or corrosion from battery and cables with sodium bicarbonate (baking soda) and water solution.

Put Battery Saver (6988074) or grease on the battery terminals and cable ends to prevent corrosion.

WARNING

AVOID INJURY OR DEATH

Batteries contain acid which burns eyes and skin on contact. Wear goggles, protective clothing and rubber gloves to keep acid off body.

In case of acid contact, wash immediately with water. In case of eye contact get prompt medical attention and wash eye with clean, cool water for at least 15 minutes.

If electrolyte is taken internally drink large quantities of water or milk! DO NOT induce vomiting. Get prompt medical attention.

W-2065-0807

Using A Booster Battery (Jump Starting)

If it is necessary to use a booster battery to start the engine, BE CAREFUL! There must be one person in the operator's seat and one person to connect and disconnect the battery cables.

Figure 127

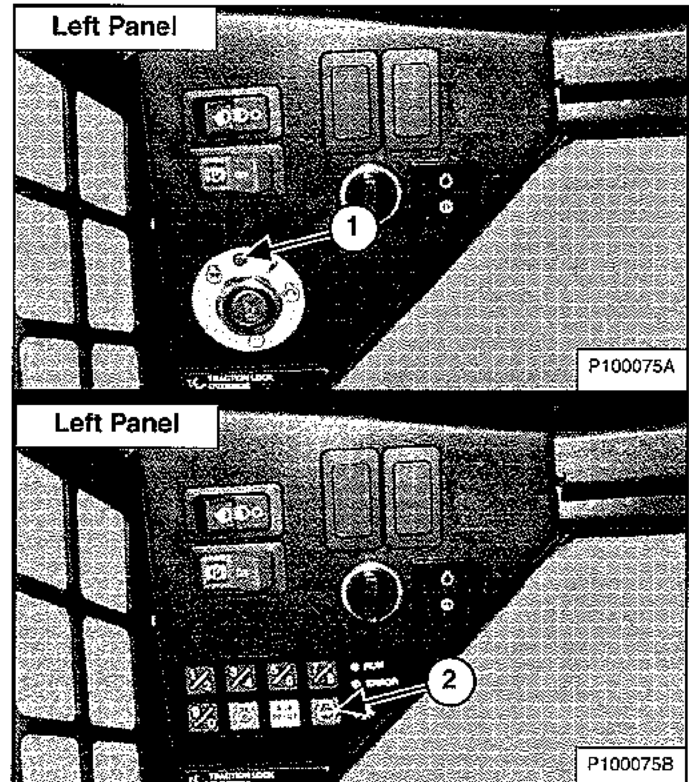

The key switch (Item 1) must be in the OFF position or the STOP button (Item 2) [Figure 127] must be pressed. The booster battery must be 12 volt.

WARNING

BATTERY GAS CAN EXPLODE AND CAUSE SERIOUS INJURY OR DEATH

Keep arcs, sparks, flames and lighted tobacco away from batteries. When *jumping* from booster battery make final connection (negative) at machine frame.

Do not jump start or charge a frozen or damaged battery. Warm battery to 16°C (60°F) before connecting to a charger. Unplug charger before connecting or disconnecting cables to battery. Never lean over battery while boosting, testing or charging.

W-2066-0910

ELECTRICAL SYSTEM (CONT'D)

Using A Booster Battery (Jump Starting) (Cont'd)

! WARNING

AVOID INJURY OR DEATH

Batteries contain acid which burns eyes and skin on contact. Wear goggles, protective clothing and rubber gloves to keep acid off body.

In case of acid contact, wash immediately with water. In case of eye contact get prompt medical attention and wash eye with clean, cool water for at least 15 minutes.

If electrolyte is taken internally drink large quantities of water or milk! DO NOT induce vomiting. Get prompt medical attention.

W-2065-0807

Figure 128

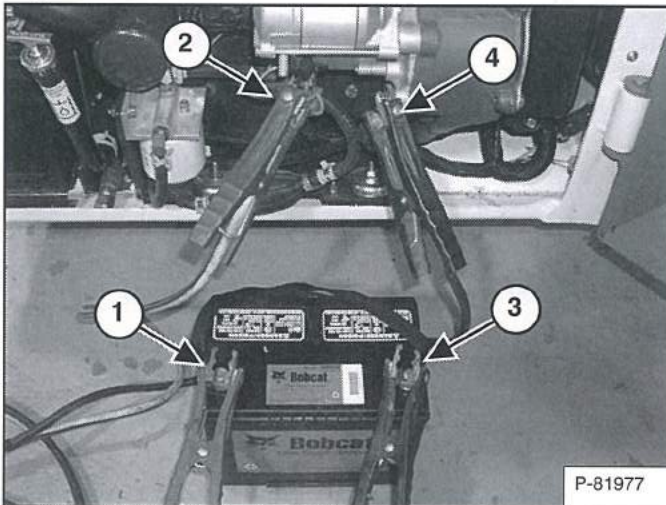

Connect the end of the first cable to the positive (+) terminal (Item 1) of the booster battery. Connect the other end of the same cable to the positive terminal (Item 2) [Figure 128] on the loader starter.

Connect the end of the second cable to the negative (-) terminal (Item 3) of the booster battery. Connect the other end of the same cable (Item 4) [Figure 128] to the engine.

NOTE: Keep cables away from moving parts.

Start the engine. (See STARTING THE ENGINE on Page 48.)

After the engine has started, remove the negative (-) cable (Item 4) [Figure 128] first.

Remove the cable from the positive terminal (Item 2) [Figure 128].

IMPORTANT

Damage to the alternator can occur if:

- Engine is operated with battery cables disconnected.
- Battery cables are connected when using a fast charger or when welding on the loader. (Remove both cables from the battery.)
- Extra battery cables (booster cables) are connected wrong.

I-2023-1285

ELECTRICAL SYSTEM (CONT'D)

Removing And Installing Battery

! WARNING

AVOID INJURY OR DEATH

Batteries contain acid which burns eyes and skin on contact. Wear goggles, protective clothing and rubber gloves to keep acid off body.

In case of acid contact, wash immediately with water. In case of eye contact get prompt medical attention and wash eye with clean, cool water for at least 15 minutes.

If electrolyte is taken internally drink large quantities of water or milk! DO NOT induce vomiting. Get prompt medical attention.

W-2065-0807

Open the rear door.

Figure 129

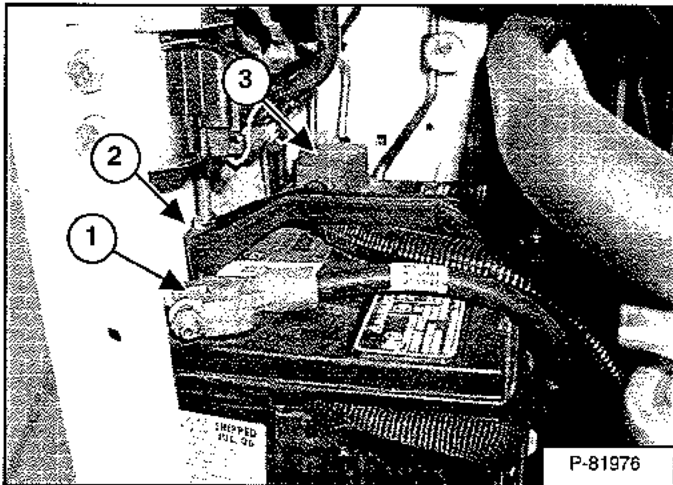

Disconnect the negative (-) battery cable (Item 1) [Figure 129].

Remove the battery hold-down clamp (Item 2) [Figure 129].

Disconnect the positive (+) cable (Item 3) [Figure 129] from the battery.

Remove the battery from the loader.

NOTE: When removing or installing the battery in the loader, do not touch any metal parts with the battery terminals.

Figure 130

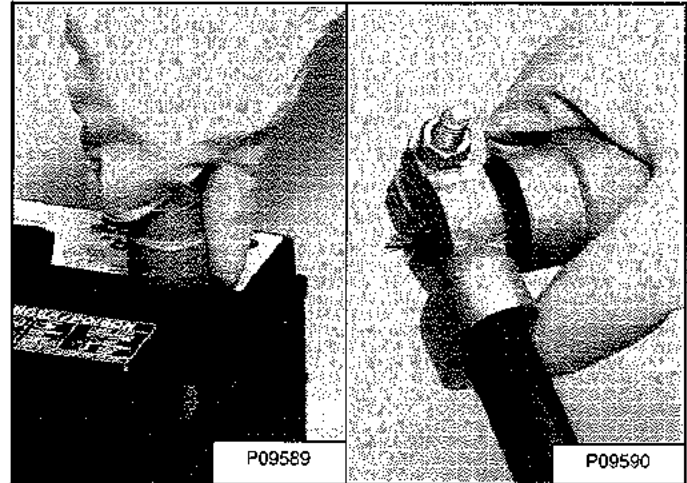

Always clean the battery terminals and cable ends when installing a new or used battery [Figure 130].

NOTE: Always connect the negative (-) cable last and remove it first to prevent sparks.

Connect the positive (+) battery cable.

Install and tighten the battery hold-down clamp.

Connect the negative (-) battery cable.

Close the rear door before operating the loader.

HYDRAULIC / HYDROSTATIC SYSTEM

Checking And Adding Fluid

Check the hydraulic / hydrostatic fluid level every day before starting the work shift.

Park the loader on a level surface.

Lower the lift arms and tilt the Bob-Tach fully back.

Stop the engine and exit the loader. (See STOPPING THE ENGINE AND LEAVING THE LOADER on Page 53.)

Figure 131

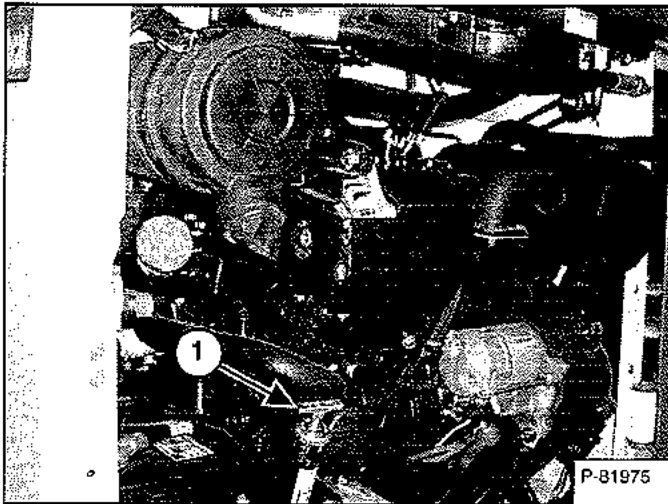

Remove the dipstick (Item 1) [Figure 131] and allow the oil level to stabilize for 10 - 15 seconds. Install the dipstick and remove to check the fluid level.

NOTE: Hydraulic oil level in the dipstick tube must be allowed to stabilize before it is checked or the dipstick may incorrectly indicate a low fluid condition.

If fluid is needed, add fluid through the dipstick / fill tube.

Hydraulic / Hydrostatic Fluid Chart

Figure 132

HYDRAULIC / HYDROSTATIC FLUID RECOMMENDED ISO VISCOSITY GRADE (VG) AND VISCOSITY INDEX (VI)

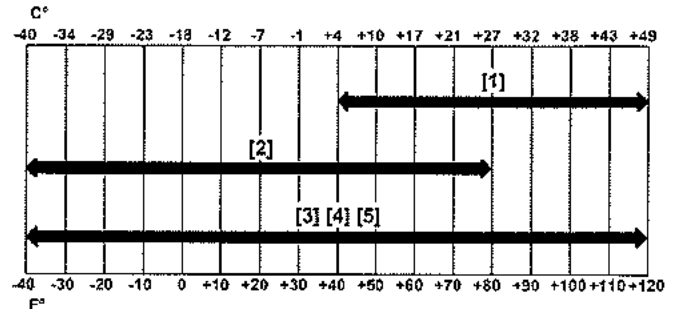

TEMPERATURE RANGE ANTICIPATED DURING MACHINE USE

- [1] VG 100; Minimum VI 130
- [2] VG 46; Minimum VI 150
- [3] BOBCAT All-Season Fluid
- [4] BOBCAT Synthetic Fluid
- [5] BOBCAT Biodegradable Hydraulic / Hydrostatic Fluid (Unlike biodegradable fluids that are vegetable based, Bobcat biodegradable fluid is formulated to prevent oxidation and thermal breakdown at operating temperatures.)

Use only recommended fluid in the hydraulic system [Figure 132]. (See Hydraulic System on Page 131.)

HYDRAULIC / HYDROSTATIC SYSTEM (CONT'D)

Removing And Replacing Hydraulic Fluid

For the correct service interval (See SERVICE SCHEDULE on Page 71.)

Replace the fluid if it becomes contaminated or after major repair.

Always replace the hydraulic / hydrostatic filter whenever the hydraulic fluid is replaced. (See Removing And Replacing Hydraulic / Hydrostatic Filter on Page 97.)

Figure 133

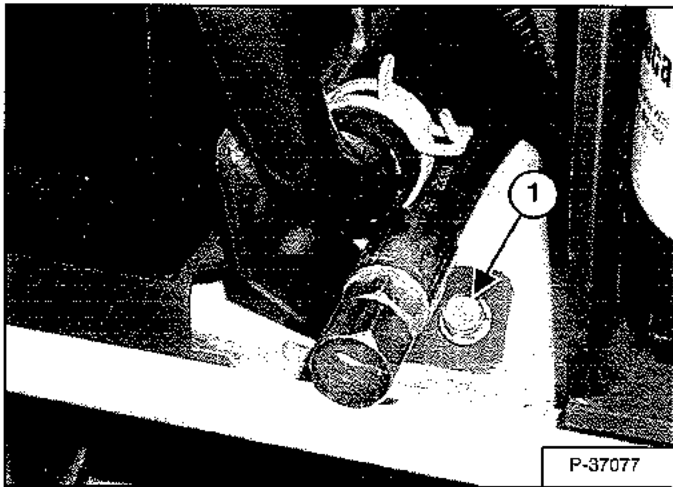

Remove the bolt (Item 1) [Figure 133] from the dipstick / fill tube mounting bracket.

Figure 134



Remove the dipstick from the hydraulic fill tube and rotate the tube down into a container [Figure 134] to drain the reservoir.

NOTE: Fluids such as engine oil, hydraulic fluid, coolant, etc. must be disposed of in an environmentally safe manner. Some regulations require that certain spills and leaks on the ground must be cleaned in a specific manner. See local, state and federal regulations for correct disposal.

After the hydraulic fluid is completely drained, rotate the hydraulic fill tube back to the original position and reinstall the bolt (Item 1) [Figure 133] to the fill tube mounting bracket.

Fill the hydraulic system with the correct amount and type of hydraulic fluid. (See Hydraulic / Hydrostatic Fluid Chart on Page 95.) and (See Capacities on Page 132.)

HYDRAULIC / HYDROSTATIC SYSTEM (CONT'D)

Removing And Replacing Hydraulic / Hydrostatic Filter

For the correct service interval (See SERVICE SCHEDULE on Page 71.)

Stop the engine and exit the loader. (See STOPPING THE ENGINE AND LEAVING THE LOADER on Page 53.)

Raise the operator cab. (See Raising on Page 80.)

Figure 135

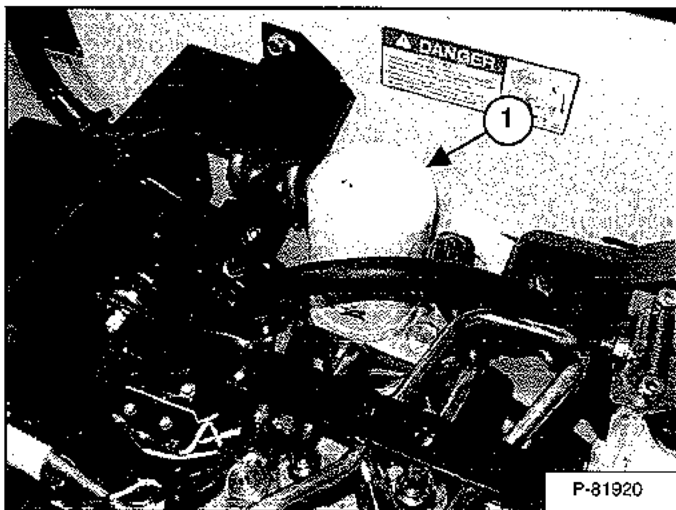

Remove the filter (Item 1) [Figure 135].

Clean the surface of the filter housing where the filter seal contacts the housing.

Put clean oil on the seal of the new filter element. Install and hand tighten the filter element.

WARNING

AVOID INJURY OR DEATH

Always clean up spilled fuel or oil. Keep heat, flames, sparks or lighted tobacco away from fuel and oil. Failure to use care around combustibles can cause explosion or fire.

W-2103-0508

Lower the operator cab. (See Lowering on Page 81.)

Start the engine and operate the loader hydraulic controls.

Stop the engine and exit the loader. (See STOPPING THE ENGINE AND LEAVING THE LOADER on Page 53.)

Check for leaks at the filter.

WARNING

AVOID INJURY OR DEATH

Diesel fuel or hydraulic fluid under pressure can penetrate skin or eyes, causing serious injury or death. Fluid leaks under pressure may not be visible. Use a piece of cardboard or wood to find leaks. Do not use your bare hand. Wear safety goggles. If fluid enters skin or eyes, get immediate medical attention from a physician familiar with this injury.

W-2072-0807

Check fluid level and add as needed. (See Checking And Adding Fluid on Page 95.)

Breather Cap

Replace the breather cap at the correct service interval. (See SERVICE SCHEDULE on Page 71.)

Raise the cab. (See Raising on Page 80.)

Figure 136



Thoroughly clean the area around the breather cap.

Remove the breather cap (Item 1) [Figure 136] and discard.

Install new breather cap.

Lower the cab. (See Lowering on Page 81.)

SPARK ARRESTER MUFFLER

Cleaning Procedure

See the SERVICE SCHEDULE for service interval for cleaning the spark arrester muffler. (See SERVICE SCHEDULE on Page 71.)

Do not operate the loader with a defective exhaust system.

IMPORTANT

This machine is factory equipped with a U.S.D.A. Forestry Service approved spark arrester exhaust system.

The spark arrester muffler, if equipped, must be cleaned to keep it in working condition. The spark arrester muffler must be serviced by dumping the spark chamber every 100 hours of operation.

On some models, the turbocharger functions as the spark arrester and must operate correctly for proper spark arrester function.

If this machine is operated on flammable forest, brush, or grass covered land, it must be equipped with a spark arrester attached to the exhaust system and maintained in working order. Failure to do so will be in violation of California State Law, Section 4442. PRC. Refer to local laws and regulations for spark arrester requirements.

I-2284-0111

Stop the engine and exit the loader. (See STOPPING THE ENGINE AND LEAVING THE LOADER on Page 53.) Open the rear door.

Figure 137

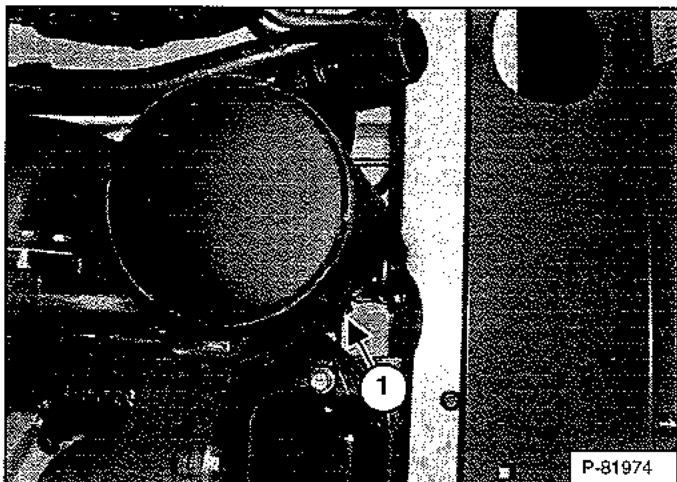

Remove the plug (Item 1) [Figure 137] from the bottom of the muffler.

! WARNING

When the engine is running during service, the driving and steering controls must be in neutral and the parking brake engaged. Failure to do so can cause injury or death.

W-2006-1209

Start the engine and run for about 10 seconds while a second person, wearing safety goggles, holds a piece of wood over the outlet of the muffler. This will force contaminants out through the cleanout hole.

Stop the engine and exit the loader. (See STOPPING THE ENGINE AND LEAVING THE LOADER on Page 53.)

Install and tighten the plug. Close the rear door.

! WARNING

AVOID INJURY OR DEATH

When an engine is running in an enclosed area, fresh air must be added to avoid concentration of exhaust fumes. If the engine is stationary, vent the exhaust outside. Exhaust fumes contain odorless, invisible gases which can kill without warning.

W-2050-0807

! WARNING

Stop engine and allow the muffler to cool before cleaning the spark chamber. Wear safety goggles. Failure to obey can cause serious injury.

W-2011-1285

! WARNING

Never use machine in atmosphere with explosive dust or gases or where exhaust can contact flammable material. Failure to obey warnings can cause injury or death.

W-2068-1285

TIRE MAINTENANCE

Wheel Nuts

Figure 138

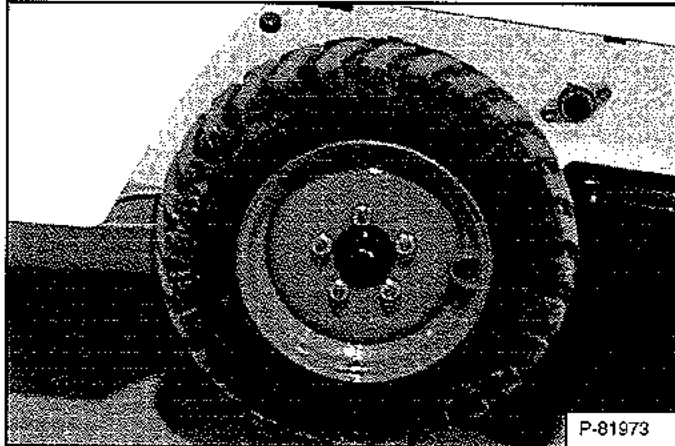

See the SERVICE SCHEDULE for the service interval to check the wheel nuts [Figure 138]. (See SERVICE SCHEDULE on Page 71.)

When *installing* wheel nuts, tighten to 217 N•m (160 ft-lb) torque.

When *checking* wheel nut torque, set the torque wrench to 190 N•m (140 ft-lb) to prevent over-tightening.

Rotating

Check the tires regularly for wear, damage and pressure. Inflate tires to the maximum pressure shown on the sidewall of the tire.

Figure 139

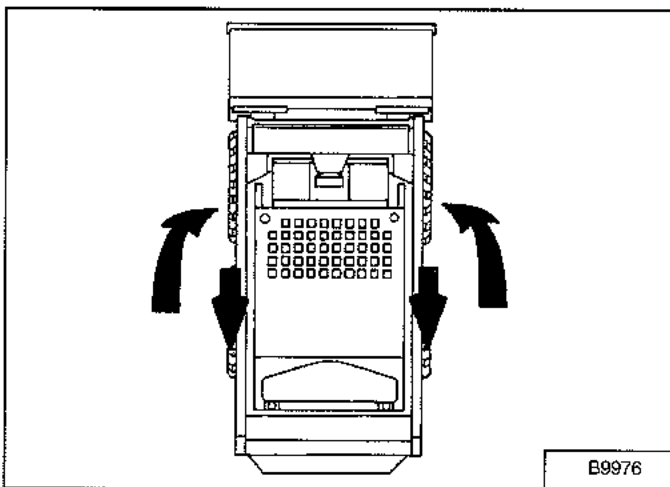

Rear tires usually wear faster than front tires. To keep tire wear even, move the front tires to the rear and rear tires to the front [Figure 139].

It is important to keep all tires the same size. If different sizes are used, each tire will be turning at a different rate and cause excessive wear. The tread bars of all the tires must face the same direction.

Recommended tire pressure must be maintained to avoid excessive tire wear and loss of stability and handling capability. Check for the correct pressure before operating the loader.

Mounting

Tires are to be repaired only by an authorized person using the proper procedures and safe equipment.

Tires and rims must always be checked for correct size before mounting. Check rim and tire bead for damage.

The rim flange must be cleaned and free of rust.

The tire bead and rim flange must be lubricated with a rubber lubricant before mounting the tire.

Avoid excessive pressure which can rupture the tire and cause serious injury or death.

During inflation of the tire, check the tire pressure frequently to avoid over inflation.

WARNING

AVOID INJURY OR DEATH

Do not inflate tires above specified pressure. Failure to use correct tire mounting procedure can cause an explosion which can result in injury or death.

W-2078-1007

IMPORTANT

Inflate tires to the **MAXIMUM** pressure shown on the sidewall of the tire. **DO NOT** mix brands of tires used on the same machine.

I-2057-1010

FINAL DRIVE TRANSMISSION (CHAINCASE)

Checking And Adding Oil

The chaincase contains the final drive sprockets and chains. Use the same type of oil as the hydraulic / hydrostatic system.

Park the loader on a level surface.

Stop the engine and exit the loader. (See STOPPING THE ENGINE AND LEAVING THE LOADER on Page 53.)

Install jackstands under the rear corners of the loader frame.

Enter the loader and raise the loader lift arms. Install the Lift Arm Support Device. (See LIFT ARM SUPPORT DEVICE on Page 76.)

Stop the engine and exit the loader. (See STOPPING THE ENGINE AND LEAVING THE LOADER on Page 53.)

Figure 140

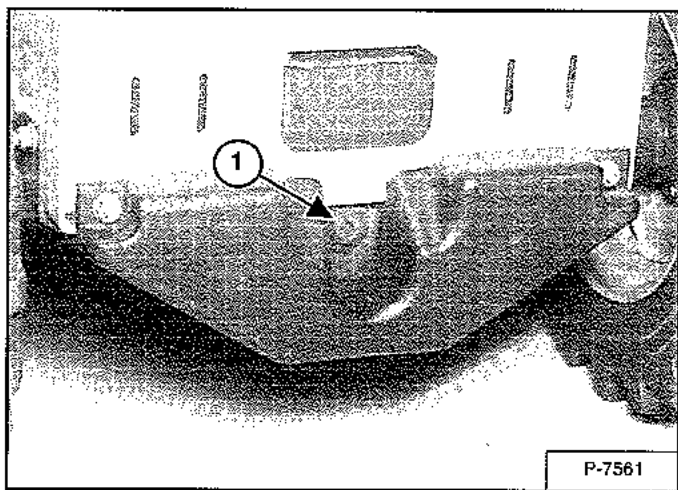

Remove the check plug (Item 1) [Figure 140] from the front of the chaincase housing.

If oil can be reached with the tip of your finger through the hole, the oil level is correct.

If the level is low, add lubricant through the check plug hole until the oil flows from the hole.

Install and tighten the plug.

Lower the lift arms. (See LIFT ARM SUPPORT DEVICE on Page 76.)

Remove jackstands.

Removing And Replacing Oil

Park the loader on a level surface.

Stop the engine and exit the loader. (See STOPPING THE ENGINE AND LEAVING THE LOADER on Page 53.)

Install jackstands under the rear corners of the loader frame.

Enter the loader and raise the loader lift arms. Install the Lift Arm Support Device. (See LIFT ARM SUPPORT DEVICE on Page 76.)

Stop the engine and exit the loader. (See STOPPING THE ENGINE AND LEAVING THE LOADER on Page 53.)

Remove the check plug (Item 1) [Figure 140] from the front of the chaincase housing.

Figure 141

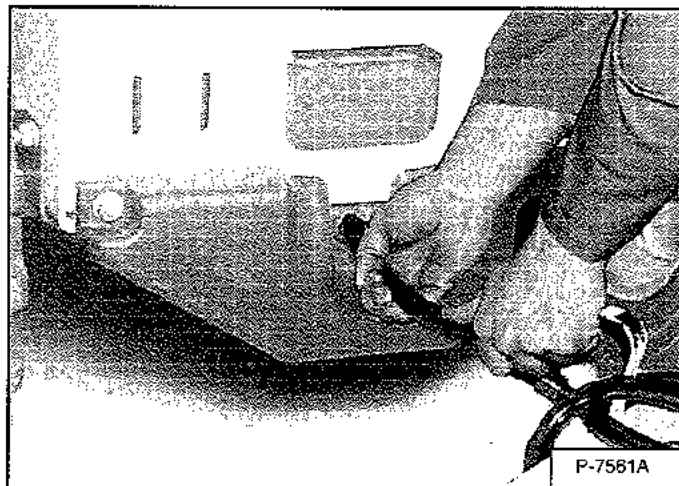

Use a pump to suction the oil from the chaincase [Figure 141].

Recycle or dispose of the used oil in an environmentally safe manner.

Add new oil until the oil flows from the hole.

Install and tighten the plug.

Lower the lift arms. (See LIFT ARM SUPPORT DEVICE on Page 76.)

Remove jackstands.

ALTERNATOR BELT

Belt Adjustment

Stop the engine and exit the loader. (See STOPPING THE ENGINE AND LEAVING THE LOADER on Page 53.)

Open the rear door. (See REAR DOOR (TAILGATE) on Page 83.)

Figure 142

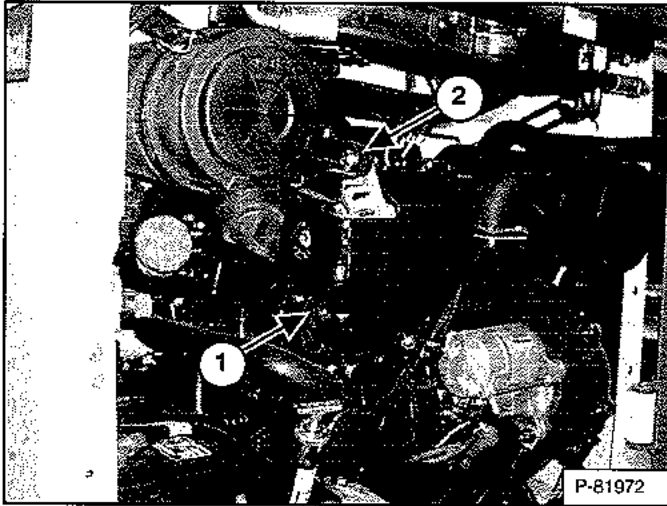

Loosen the alternator mounting bolt (Item 1) [Figure 142].

Loosen the adjustment bolt (Item 2) [Figure 142].

The tension is correct with 6 mm (1/4 in) belt movement at mid span when 67 N (15 lb) force is applied to the belt.

Tighten the adjustment bolt and mounting bolt.

Close the rear door.

Belt Replacement

Stop the engine and exit the loader. (See STOPPING THE ENGINE AND LEAVING THE LOADER on Page 53.)

Open the rear door. (See REAR DOOR (TAILGATE) on Page 83.)

Loosen the alternator mounting and adjustment bolts (Items 1 and 2) [Figure 142] and loosen the belt all the way.

Remove the belt and install a new belt.

The tension is correct with 6 mm (1/4 in) belt movement at mid span when 67 N (15 lb) force is applied to the belt.

Tighten the adjustment bolt and mounting bolt.

Close the rear door.

DRIVE BELT

Belt Adjustment

The drive belt does not need adjustment. The belt has a spring loaded idler which is constantly adjusted.

Belt Replacement

Stop the engine and exit the loader. (See STOPPING THE ENGINE AND LEAVING THE LOADER on Page 53.)

Open the rear door and disconnect the negative (-) cable from the battery.

Figure 143

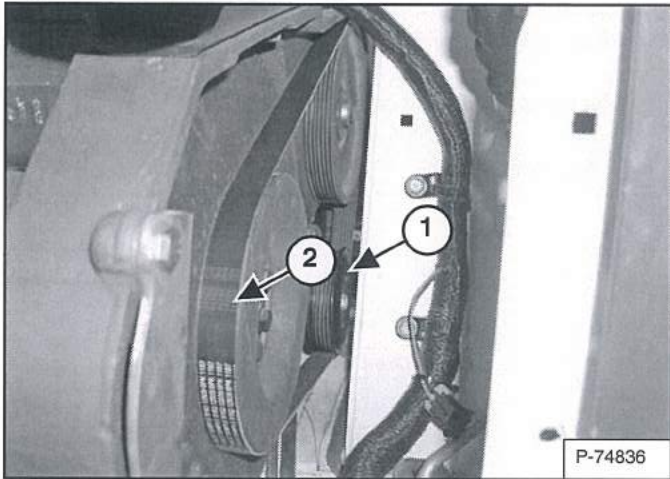

Use a socket wrench (without socket) to move the spring loaded belt tensioner (Item 1) **[Figure 143]** upward.

While holding the spring loaded belt tensioner up, you can remove the drive belt (Item 2) **[Figure 143]**.

Carefully lower the spring loaded belt tensioner to its stop.

Install a new drive belt by reversing the above procedure.

LUBRICATING THE LOADER

Lubrication Locations

Lubricate the loader as specified for the best performance of the loader. (See SERVICE SCHEDULE on Page 71.)

Record the operating hours each time you lubricate the Bobcat Loader.

Always use a good quality lithium based multipurpose grease when you lubricate the loader. Apply the lubricant until extra grease shows.

Lubricate the following locations on the loader:

Figure 144

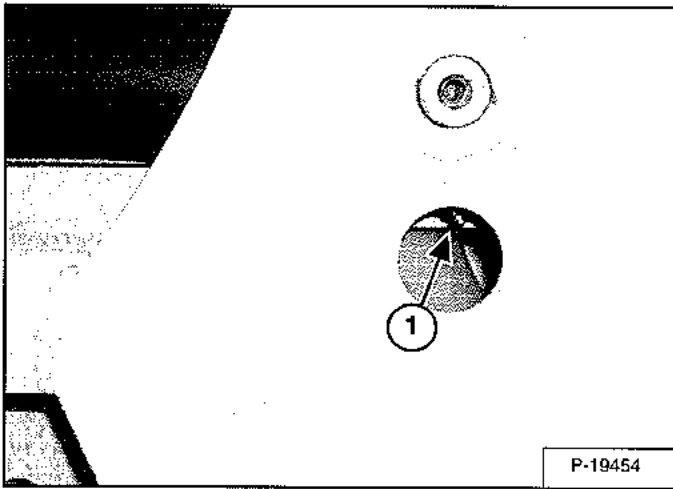

1. Base End Lift Cylinder (Both Sides) [Figure 144].

Figure 145

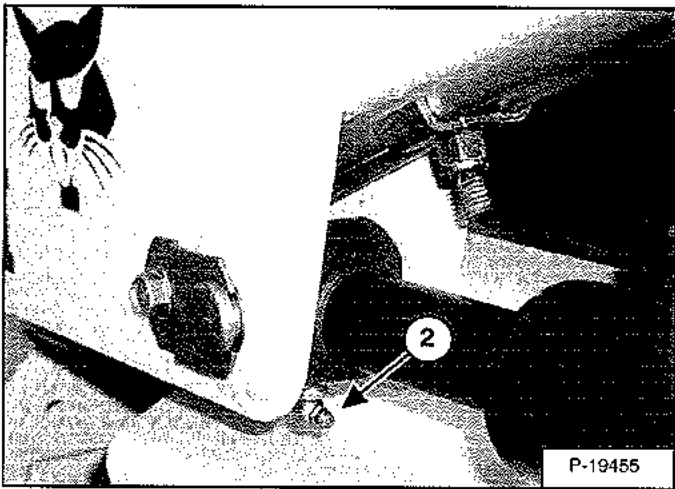

2. Rod End Lift Cylinder (Both Sides) [Figure 145].

Figure 146

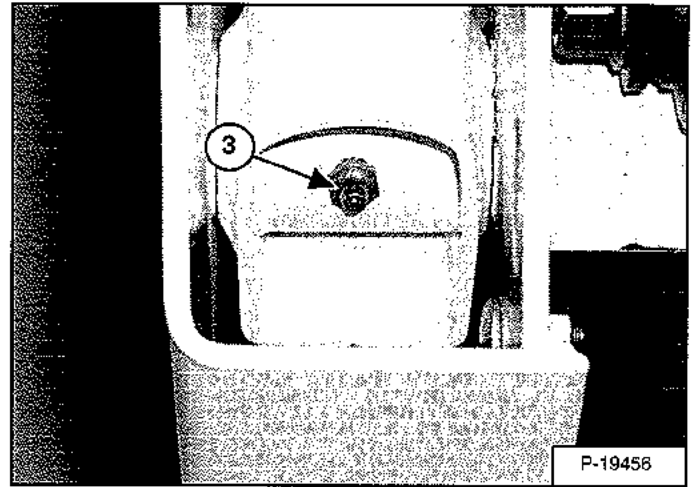

3. Lift Arm Pivot Pin (Both Sides) [Figure 146].

Figure 147

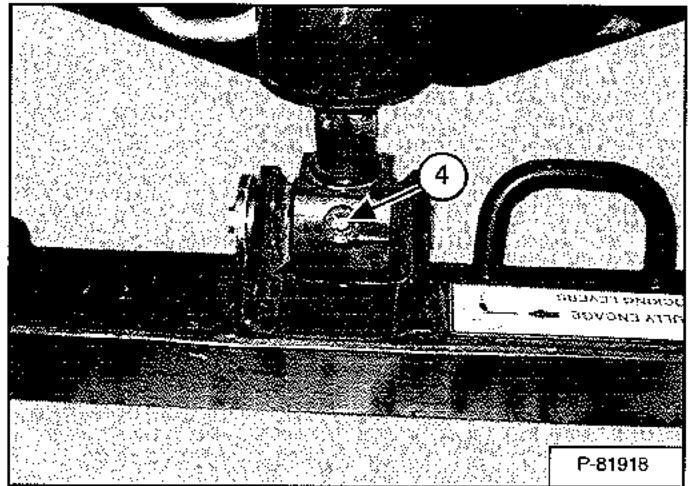

4. Rod End Tilt Cylinder [Figure 147].

LUBRICATING THE LOADER (CONT'D)

Lubrication Locations (Cont'd)

Figure 148

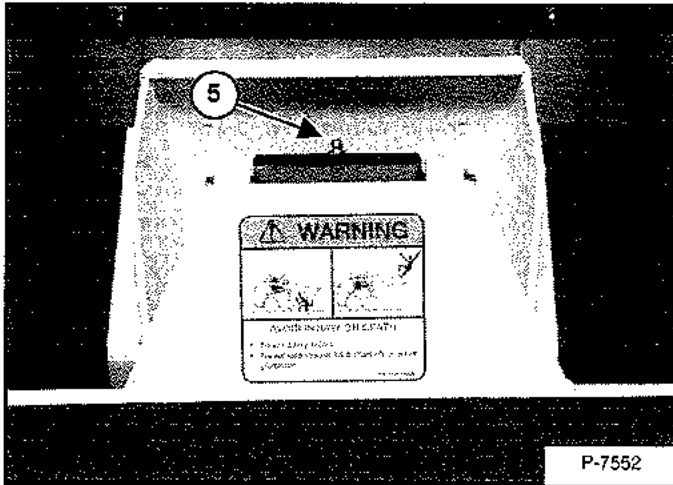

5. Base End Tilt Cylinder [Figure 148].

Figure 149

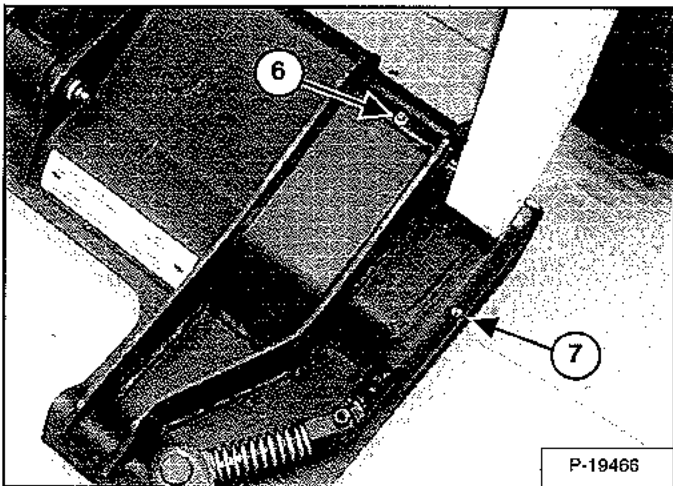

6. Bob-Tach Pivot Pin (Both Sides) [Figure 149].

7. Bob-Tach Wedge (Both Sides) [Figure 149].

Figure 150

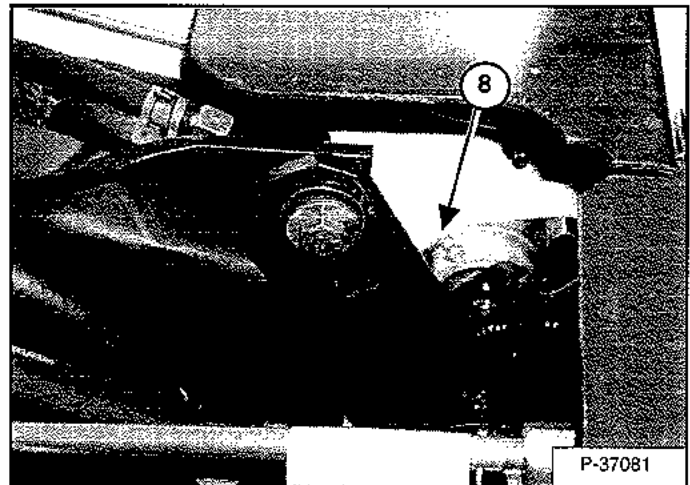

8. 250 Hours: Steering shaft pivot bearings (Both Sides) [Figure 150].

PIVOT PINS

Inspection And Maintenance

Figure 151

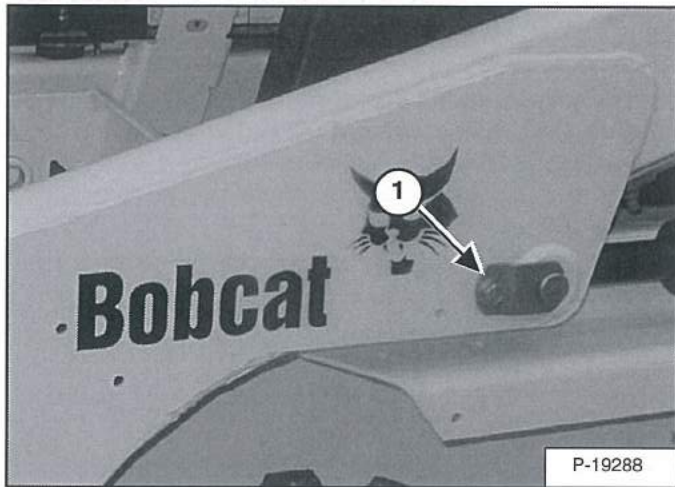
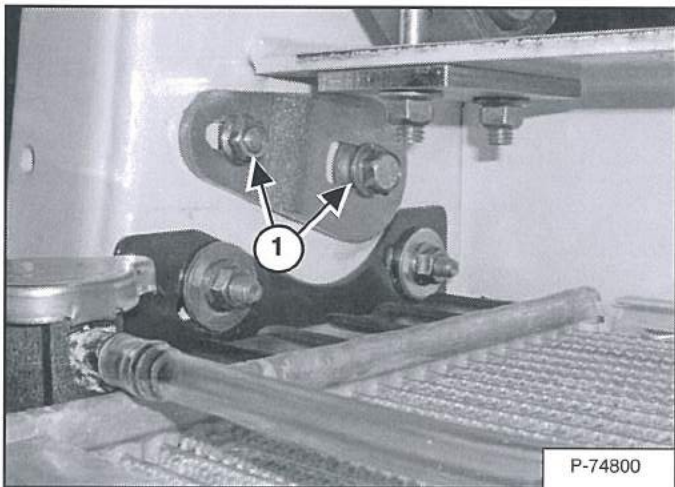

Figure 152



All lift arm and cylinder pivots have a large pin held in position with a retainer bolt and lock nut (Item 1) [Figure 151] and [Figure 152].

Tighten to 24 - 27 N•m (18 - 20 ft-lb) torque.

Do not over tighten.

Figure 153

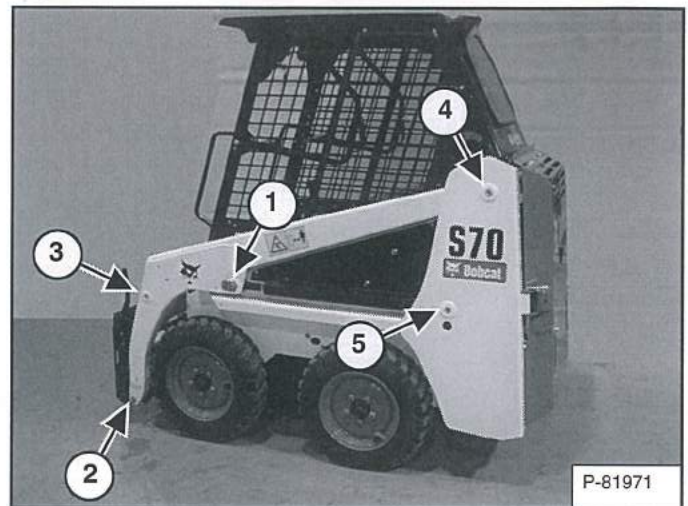
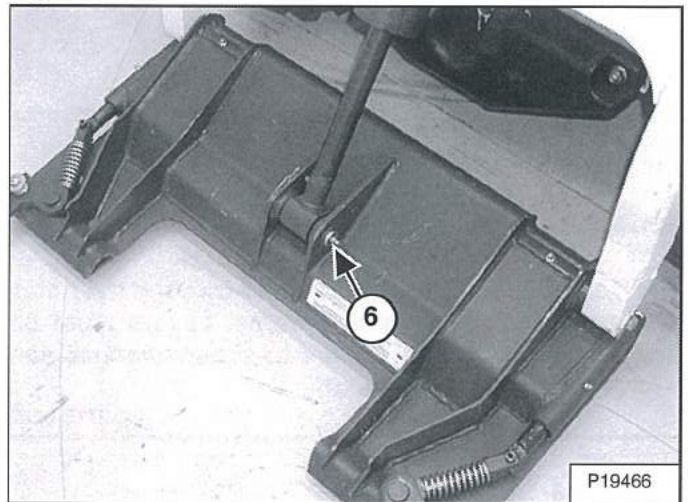

Figure 154



Check the following pivot pins (Items 1 - 6) [Figure 153] and [Figure 154].

Repeat for (Items 1 - 5) [Figure 153] on the opposite side of the loader.

BOB-TACH

Inspection And Maintenance

Figure 155

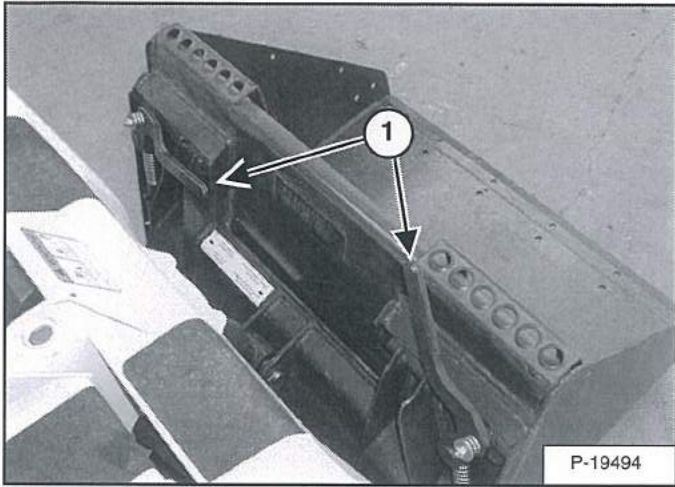

Move the Bob-Tach levers down to engage the wedges [Figure 155].

The levers and wedges must move freely.

WARNING

AVOID INJURY OR DEATH

The Bob-Tach wedges must extend through the holes in the attachment mounting frame. Levers must be fully down and locked. Failure to secure wedges can allow attachment to come off.

W-2715-0208

Figure 156

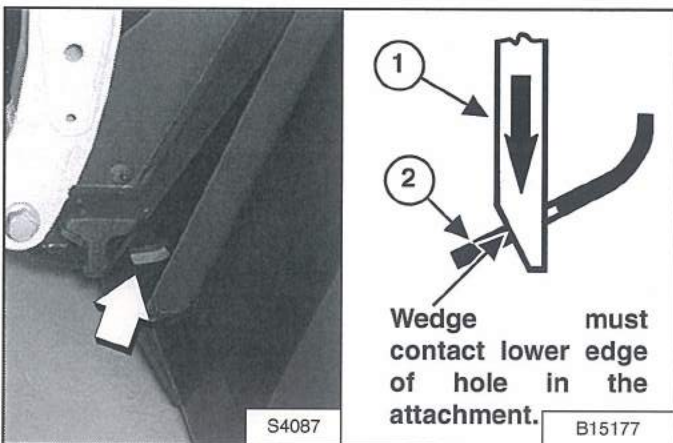

The wedges (Item 1) must extend through the holes in the attachment mounting frame (Item 2) [Figure 156].

The spring loaded wedge (Item 1) [Figure 156] must contact the lower edge of the hole in the attachment (Item 2).

If the wedge does not contact the lower edge of the hole [Figure 156], the attachment will be loose and can come off the Bob-Tach.

Figure 157

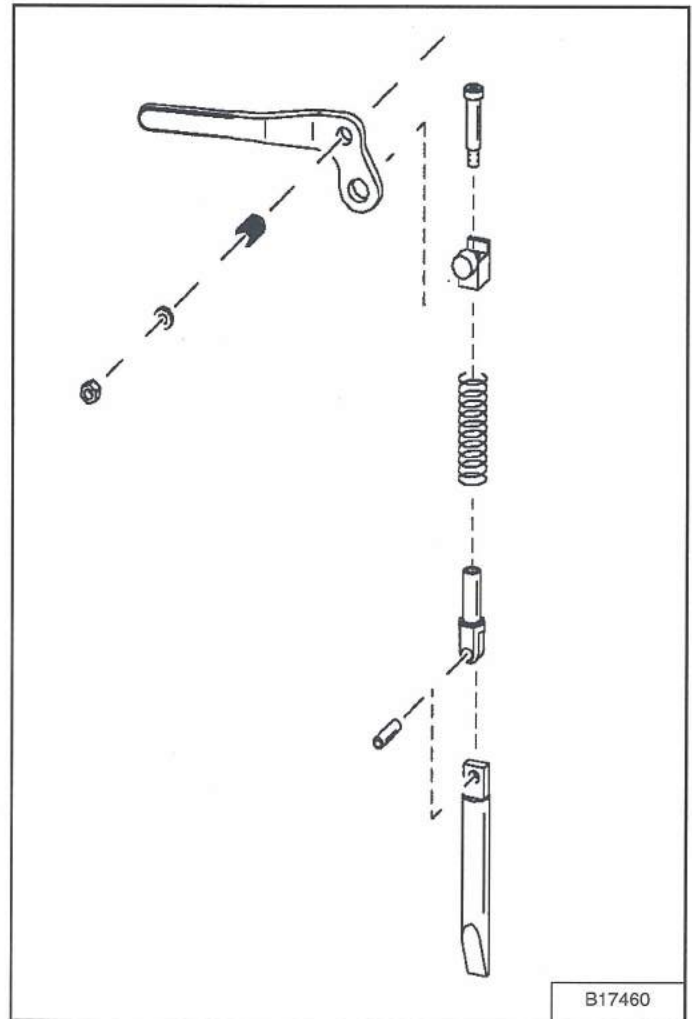

Inspect the mounting frame on the attachment and Bob-Tach, linkages and wedges for excessive wear or damage [Figure 157]. Replace any parts that are damaged, bent or missing. Keep all fasteners tight.

Look for cracked welds. Contact your Bobcat dealer for repair or replacement parts.

Lubricate the wedges. (See SERVICE SCHEDULE on Page 71.) and (See LUBRICATING THE LOADER on Page 103.)

LOADER STORAGE AND RETURN TO SERVICE

Storage

Sometimes it may be necessary to store your Bobcat Loader for an extended period of time. Below is a list of items to perform before storage.

- Thoroughly clean the loader including the engine compartment.
- Lubricate the loader.
- Replace worn or damaged parts.
- Park the loader in a dry protected shelter.
- Lower the lift arms all the way and put the bucket flat on the ground.
- Put blocks under the frame to remove weight from the tires.
- Put grease on any exposed cylinder rods.
- Put fuel stabilizer in the fuel tank and run the engine a few minutes to circulate the stabilizer to the pump and fuel injectors.
- Drain and flush the cooling system. Refill with premixed coolant.
- Replace all fluids and filters (engine, hyd. / hydro.).
- Replace air cleaner, heater and air conditioning filters.
- Put all controls in neutral position.
- Remove the battery. Be sure the electrolyte level is correct then charge the battery. Store it in a cool dry place above freezing temperatures and charge it periodically during storage.
- Cover the exhaust pipe opening.
- Tag the machine to indicate that it is in storage condition.

Return To Service

After the Bobcat Loader has been in storage, it is necessary to follow a list of items to return the loader to service.

- Check the engine and hydraulic oil levels; check coolant level.
- Install a fully charged battery.
- Remove grease from exposed cylinder rods.
- Check all belt tensions.
- Be sure all shields and guards are in place.
- Lubricate the loader.
- Check tire inflation and remove blocks from under frame.
- Remove cover from exhaust pipe opening.
- Start the engine and let run for a few minutes while observing the instrument panels and systems for correct operation.
- Operate machine, check for correct function.
- Stop the engine and check for leaks. Repair as needed.



Bobcat®

SYSTEM SETUP AND ANALYSIS

TROUBLESHOOTING	111
Troubleshooting The Engine	111
Troubleshooting The Hydraulic System	112
Troubleshooting The Hydrostatic System	112
BOBCAT INTERLOCK CONTROL SYSTEM (BICS™)	113
Troubleshooting	113
Viewing Diagnostic Service Codes	113



Bobcat®

TROUBLESHOOTING

The following information identifies loader problems which can occur most often. Service procedures for correcting loader problems can be found in this manual on the pages indicated. Some procedures are marked DS (Dealer Service) and must be performed only by qualified Bobcat service personnel.



AVOID INJURY OR DEATH

When operating the machine:

- Keep the seat belt fastened snugly.
- The seat bar must be lowered.
- Keep your feet on the pedal controls or footrests and hands on the controls.

W-2261-0909

Troubleshooting The Engine

PROBLEM	CAUSE	CORRECTION
Engine will not turn over with starter.	Battery has low charge.	Charge battery and find cause for loss of charge.
	Cables loose or dirty.	Clean and tighten battery cables.
	Damaged starter, solenoid or wiring	Check the starting circuit.
Engine turns with starter, but is difficult to start.	Wrong starting procedure.	Use correct starting procedure.
	No fuel in tank.	Add fuel.
	Dirt or water in fuel system.	Perform maintenance as needed.
	Damaged fuel pump.	Make repairs as needed.
	Fuel filter is dirty.	Install new filter.
	Hole in fuel line.	Make repairs as needed.
	Wrong oil in engine.	See Oil Specification
	Engine has lost compression.	Recondition the engine.
	Engine has overheated.	Check cooling system.
	Poor fuel quality.	Use fresh, good quality fuel.
Engine has little power or runs rough.	Dirt, water or air in fuel system.	Clean and repair as needed.
	Engine has overheated.	Check cooling system
	Governor adjustment is wrong.	Check and make adjustment if needed.
	Dirty air cleaner filter.	Check air cleaner, replace filter as needed.
	Engine has lost compression	Recondition the engine.
Engine overheats.	Cooling system is dirty. Air flow restricted.	Clean cooling system
	Engine shrouding damaged or missing.	Repair or replace.
	Engine is overloaded.	Run at full rpm

TROUBLESHOOTING (CONT'D)

Troubleshooting The Hydraulic System

PROBLEM	CAUSE	CORRECTION
No hydraulic action.	No hydraulic fluid.	Check fluid level and add as needed.
	Pedals are disconnected.	Check linkage. Repair as needed.
	Relief valve is damaged.	Replace the relief valve.
	Hydraulic pump is damaged.	Check pump and replace as needed.
	Hydraulic fluid is too thick. (cold temperature)	Let engine run to warm the hydraulic fluid.
Hydraulic action is rough.	Hydraulic fluid level is low.	Check fluid level and add as needed.
Hydraulic action is slow.	Pedal is hitting floor or debris under pedal.	Check adjustment. Remove dirt.
	Cylinders leak internally.	Check condition of cylinders and repair as needed.
	Hydraulic pump is damaged.	Check pump and replace as needed.
	Control valve is damaged	Check valve and repair as needed.
	Hydraulic fluid is too thick. (cold temperature)	Let engine run to warm the hydraulic fluid.
Hydraulic cylinders leak fluid.	Damage to cylinder rods or seals.	Repair cylinders.
No hydraulic flow to the front auxiliary hydraulic couplers.	Auxiliary hydraulic interlock valve closed.	Check auxiliary hydraulic interlock valve and solenoid for proper function. Repair or replace as needed.



Troubleshooting The Hydrostatic System

PROBLEM	CAUSE	CORRECTION
No drive on both sides.	Hydraulic fluid is low.	Check fluid level. Add as needed.
	10 Micron filter is damaged.	Replace filter.
	Damaged gear pump.	Check condition of gear pump and replace if bad.
No drive on one side.	Hydrostatic system is damaged.	Check hydrostatic system.
	Control linkage is disconnected.	Repair linkage.
Machine pulls to one side.	Wrong tire pressure.	Check all tires
	Steering linkage interference.	Check steering linkage
	Damaged hydrostatic pump / motor.	Check system.
Machine moves when levers are in neutral.	Steering linkage out of adjustment.	Adjust steering linkage.
System is overheating.	Hydraulic fluid level is low.	Check fluid level.
	Plugged filter.	Install new filter element.
	Low charge pressure.	Check bypass valve.
	Bobcat is overloaded.	Use correct size attachment and run engine at full rpm.
	Hydrostatic transmission damaged.	Check hydrostatic system.

BOBCAT INTERLOCK CONTROL SYSTEM (BICS™)

Troubleshooting

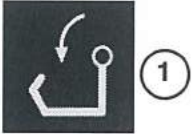
The following list shows the probable causes when the BICS™ lights are off or flashing and the associated service codes. (See TROUBLESHOOTING on Page 111.)

Indicator Light	Light ON	Light OFF	Effect on Operation of Loader when Light is ON
	Seat Bar <u>is</u> up.	Seat Bar is down.	Lift and tilt functions will not operate.
	Control valve <u>cannot</u> be used.	Control valve can be used.	Lift and tilt functions will not operate.
	Loader cannot be moved forward and backward.	Loader <u>can</u> be moved forward and backward.	Loader cannot be moved forward and backward.

Viewing Diagnostic Service Codes

The Seat Bar Light (Item 1), Valve Light (Item 2) and Parking Brake Light (Item 3) will flash to indicate SERVICE CODES. These lights may flash while the engine is running or with the engine OFF and the key ON.

NOTE: Multiple SERVICE CODES and / or abnormal symptoms can be caused by a corroded or loose ground. Check grounds and both battery connections.

The list below contains SERVICE CODES. These codes help analyze monitored functions of your Bobcat loader. Some service procedures must be performed ONLY BY QUALIFIED BOBCAT SERVICE PERSONNEL.

Indicator Light	LED	Function	Failure
1	Seat Bar - 2 Flashes	Seat Sensor	Out of Range Low
		8 Volt Sensor Supply	Out of Range Low
1	Seat Bar - 3 Flashes	Seat Sensor	Out of Range High
		8 Volt Sensor Supply	Out of Range High
2	Valve - 2 Flashes	Hydraulic Lock Valve Solenoid	Short to Battery
2	Valve - 3 Flashes	Hydraulic Lock Valve Solenoid	Short to Ground
2	Valve - 4 Flashes	Hydraulic Lock Valve Solenoid	Open Circuit
3	Parking Brake - 1 Flash	Traction Lock Hold Solenoid	Open Circuit
3	Parking Brake - 2 Flashes	Traction Lock Hold Solenoid	Short to Battery
3	Parking Brake - 3 Flashes	Traction Lock Hold Solenoid	Short to Ground
3	Parking Brake - 4 Flashes	Traction Lock Pull Output	Open Circuit
3	Parking Brake - 5 Flashes	Traction Lock Pull Output	Error On
		Traction Pull Relay	Error On
3	Parking Brake - 6 Flashes	Traction Lock Pull Output	Error Off
		Traction Pull Relay	Error Off



Bobcat®

MACHINE SIGN TRANSLATIONS

MACHINE SIGN TRANSLATIONS	117
Service Schedule (6734534)	117
Warning (6579510)	120
Danger (6702301)	121
Danger (6702302)	121
Danger (6717343)	121
Warning (6579528)	121
Lift Arm Support Device (6711659)	122
Danger (7170355)	122
Warning (6737189)	123
Warning (6804233)	123
Warning (6576048)	123
Important (6732775)	123
Warning (6565491)	124
Important (6560573)	124
Warning (6710358)	125
Warning (6702255)	125
Warning (6577754)	126



Bobcat®

GENERAL LUBRICATION DIAGRAMS

RADIUS PATH MACHINE

VERTICAL PATH MACHINE

• TYPICAL GREASE POINTS

Use Genuine Bobcat Replacement Parts

SERVICE CHECKLIST AND SCHEDULE

EVERY 10 HRS (BEFORE STARTING THE LOADER)

- **ENGINE OIL & FILTER** - Check level and add as needed. Do not overfill. Change oil and filter after first 50 Hrs. from new to Operation & Maintenance Manual for proper change interval for your Model.
- **ENGINE AIR FILTER** - Check condition indicator and/or display. Service only when required. Do not use compressed air to clean elements.
- **ENGINE AIR SYSTEM** - Check for leaks and damaged components.
- **ENGINE COOLING SYSTEM** - Clean debris from grill, oil cooler and radiator. Check coolant level and add coolant mixture if required.
- **FUEL FILTER** - Remove trapped water.
- **LOADER LIFT ARMS, LIFT LINKS, CYLINDERS, BOB-TACH PIVOT & WEDGES, STEERING CYLINDERS (AWS Machines Only)** - Lubricate with multipurpose lithium based grease.
- **SEAT BELT, SEAT BAR AND CONTROL INTERLOCKS** - Check function. Repair or replace as needed. Clean dirt and debris from moving parts. Clean dirt and debris from moving parts. LHM and Tilt functions MUST NOT operate with seat bar raised.
- **BICS** - Check for correct function.
- **TIRES** - Check air pressure. Inflate to MAXIMUM pressure shown on sidewall of tire.
- **GENERAL** - Check for loose or broken parts, damaged operator cab, instrument operation, loose wheel nuts or track sprocket nuts, oil leaks, damaged or missing safety signs (labels).

EVERY 50 HRS

- **HYDRAULIC FLUID, HOSES AND TUBELINES** - Check fluid level and add if required. Check for damage and for leaks. Repair or replace as needed.
- **FINAL DRIVE TRANSMISSION (CRACKCASE, Wheel Machines Only)** - Check fluid level and add if required.
- **HYDRAULIC & STEERING CONTROLS (PEDALS, HAND, and/or JOYSTICK)** - Check for correct operation. Adjust as needed.
- **WHEEL NUTS / TRACK DRIVE SPROCKETS** - Check for loose nuts and tighten as needed.
- **TRACK TENSION (Track Machines Only)** - Check tension and adjust as needed.

EVERY 100 HRS

- **SPARK ARRESTOR MUFFLER** - Empty spark chamber. (if equipped.)
- **BATTERY** - Check battery for damage, hold down clamps, cables, connections and electrolyte level. Add distilled water as needed.
- **DRIVE LINE** - Lubricate Engine-to-Pump Coupler with multipurpose lithium based grease. (if equipped)

EVERY 250 HRS

- **STEERING LEVER PIVOTS** - Lubricate with multipurpose lithium based grease. (if equipped)
- **FUEL FILTER** - Replace filter.
- **KING PINS (AWS Machines Only)** - Lubricate with multipurpose lithium based grease.
- **ENGINE / HYDRAULIC DRIVE BELT** - Check for wear or damage. Adjust or replace as needed. (if equipped.)
- **FAN DRIVE GEARBOX** - Check fluid level and add if required. (if equipped.)
- **OTHER DRIVE BELTS (Hydrostatic pump, water pump, alternator, and air conditioner - if equipped)** - Check condition and tension. Adjust or replace as needed.
- **BICS** - Check function of Lift Arm By-Pass control.

EVERY 500 HRS

- **FAN / HYDRAULIC / HYDROSTATIC SYSTEM** - Replace filter. Replace reservoir breather cap.
- **STEERING VALVE INLINE FILTER (AWS Only)** - Replace filter.
- **HYDROSTATIC MOTOR CARRIER (Track Machines Only)** - Replace oil.

EVERY 1000 HRS

- **HYDRAULIC RESERVOIR** - Replace fluid.
- **FINAL DRIVE TRANSMISSION (Chaincase on Wheel Machines Only)** - Replace fluid.
- **TRACK ROLLER, IDLER ASSEMBLIES (Track Machines Only)** - Replace fluid (if required)
- **DRIVE MOTOR CASE DRAIN FILTER** - Replace filter (if equipped)
- **WHEEL BEARING & OUTER SPLINES (AWS only)** - Repack wheel bearings, grease internal splines in hub yoke. (Dealer Service Only)

NOTES:

- Replace element when if transmission warning indicator remains on for more than 5 minutes after hydraulic fluid is at operating temperature.
- Service at first 50 hours, then as scheduled.
- See Operation & Maintenance Manual for correct fluid specifications, filter part number and location, and appropriate service interval for your Model.

SEE OPERATION & MAINTENANCE MANUAL FOR MORE INFORMATION AND INSTRUCTIONS.

WARNING

AVOID INJURY OR DEATH

- Keep door closed except for service.
- Keep engine clean of flammable materials.
- Keep body, loose objects and clothing away from electrical contacts, moving parts, hot parts and exhaust.
- Do not use loader in space with explosive dusts or gases or with flammable material near exhaust.
- Never use ether or starting fluid on diesel engine with glow plugs. Use only starting aids as approved by engine manufacturer.
- Leaking fluids under pressure can enter skin and cause serious injury.
- Battery acid causes severe burns; wear goggles. If acid contacts eyes, skin, or clothing, flush with water. For contact with eyes, flush and get medical attention.
- Battery makes flammable and explosive gas. Keep arcs, sparks, flames and lighted tobacco away.
- For jump start, connect negative cable to loader engine last (never at the battery). After jump start, remove negative connection at the engine first.
- Exhaust gases can kill. Always ventilate.

73094 SW
6734534 enUS
THIS PUBLICATION IS THE PROPERTY OF BOBCAT

ADVERTENCIA

EVITE LESIONES O LA MUERTE

- Mantenga la puerta cerrada, excepto para efectuar el servicio.
- Mantenga el motor libre de materiales inflamables.
- Mantenga el cuerpo, los objetos sueltos y la ropa alejados de los contactos eléctricos, las piezas en movimiento, las piezas calientes y los escapes.
- No utilice la cargadora en espacios que contengan polvo, gases explosivos o material inflamable cerca del escape.
- Nunca utilice éter o líquido de arranque en un motor con bujías incandescentes. Utilice sólo los aditivos para el arranque aprobados por el fabricante del motor.
- Las fugas de líquido bajo presión pueden penetrar la piel y provocar lesiones graves.
- El ácido de la batería produce quemaduras graves; use anteojos protectores. Si el ácido entra en contacto con los ojos, la piel o la ropa, enjuague con agua. En caso de entrar en contacto con los ojos, enjuáguelos y solicite atención médica de inmediato.
- La batería genera gas inflamable y explosivo. Mantenga alejados los arcos, las chispas, las llamas y el tabaco encendido.
- Para realizar un puente de arranque, conecte en último lugar el cable negativo al motor de la cargadora (rueda a la batería). Después del puente de arranque, retire en primer lugar la conexión negativa del motor.
- Los gases del escape pueden ser letales. Ventile siempre.

LISTA DE CONTROL Y PROGRAMA DEL SERVICIO DE MANTENIMIENTO

CADA 10 HORAS (ANTES DE ENCENDER EL CARGADOR)

- **ACEITE Y FILTRO DEL MOTOR:** controle el nivel de aceite y agregue más cantidad si es necesario. No sobrecargue. Cambie el aceite y el filtro luego de las primeras 50 horas. Luego, consulte el Manual de funcionamiento y mantenimiento para ver la frecuencia de mantenimiento apropiada para el modelo de su máquina.
- **NO LÍQUIDO DE AIRE DEL MOTOR:** controle el indicador de estado y/o la pantalla. Repare sólo cuando sea necesario.
- **SISTEMA DE AIRE DEL MOTOR:** verifique si hay pedruzcos o componentes dañados.
- **SISTEMA DE ENFRÍAMIENTO DEL MOTOR:** limpie y elimine la suciedad que haya en la pantalla, en el refrigerante de aceite y en el radiador. Verifique el nivel de líquido de refrigerante y agregue la cantidad necesaria.
- **FILTRO DEL COMBUSTIBLE:** retire el agua que quede acumulada.
- **CINTURÓN DEL CARGADOR (sólo en máquinas con sistema AWS):** lubrique con engrasador multiuso a base de litio.
- **CINTURÓN DE LA BATERÍA:** limpie y lubrique con grasa.
- **SISTEMA DE ENCLAVAMIENTO DE CONTROLES BOBCAT (BICS):** verifique si funciona correctamente. Limpie la suciedad y los desechos de las piezas en movimiento. Cuando se utilicen las funciones de elevación e inclinación, **NO SE DEBE TRABAJAR** con la barra del asiento elevada.
- **NEUMÁTICOS:** verifique la presión del aire. Infile los neumáticos a la presión MÁXIMA, como se muestra en el lateral del neumático.
- **Funcionamiento:** verifique que no haya partes sueltas o rotas, que la cabina del operador no se encuentre dañada, el funcionamiento de los frenos y que las partes de la transmisión no estén flojas.
- **Control de seguridad:** verifique la señalización de seguridad dañada o faltante (etiquetas).

CADA 50 HORAS.

- **FLUIDO HIDRÁULICO, MANGUERAS Y TUBOS:** controle el nivel de fluido y agregue según sea necesario.
- **TRANSMISIÓN FINAL (sólo en las GUARDACADENAS de máquinas con ruedas):** controle el nivel de fluido y agregue según sea necesario.
- **CONTROLES DE DIRECCIÓN HIDRÁULICA (PEDALES, CONTROLES MANUALES y/o PALANCA DE MANDO):** verifique si funcionan correctamente.
- **TUERAS DE RUEDAS / ENGRANAJES DE TRANSMISIÓN DE LA TRACCIÓN:** verifique que las tuercas no estén sueltas y ajustelas según sea necesario.
- **TENSIÓN DE LA BANDA DE TRACCIÓN (sólo en máquinas de tracción):** verifique la tensión y ajústela según sea necesario.

CADA 100 HORAS.

- **SILENCIADOR PARA CHISPAS:** vacíe la cámara de chispas (si corresponde).
- **BATERÍA:** verifique la batería por daños, grietas de sujeciones, cables, conexiones y nivel de electrolitos.
- **Ajuste de la batería:** ajuste según sea necesario.
- **LÍQUIDO DE TRANSMISIÓN:** lubrique con engrasador multiuso a base de litio (si corresponde).

CADA 250 HORAS.

- **PIVOTES DE LA PALANCA DE DIRECCIÓN:** lubrique con engrasador multiuso a base de litio (si corresponde).
- **FILTRO DEL COMBUSTIBLE:** reemplace el filtro.
- **PIVOTES DE DIRECCIÓN (sólo en máquinas con sistema AWS):** lubrique con engrasador multiuso a base de litio.
- **MOTOR / CORREA IMPULSORA HIDRÁULICA:** controle que no estén gastados o dañados.
- **Ajuste o reemplace según sea necesario (si corresponde).**
- **OTROS COMPONENTES DEL VENTILADOR:** controle el nivel de fluido y agrégue según sea necesario (si corresponde).
- **OTROS COMPONENTES DEL VENTILADOR:** controle el nivel de agua, alternador y aire acondicionado, si corresponde.
- **Verifique la conexión (si corresponde).**
- **SISTEMA DE ENCLAVAMIENTO DE CONTROLES BOBCAT (BICS):** verifique el funcionamiento del control de derivación del brazo de elevación.

CADA 500 HORAS.

- **VENTILADOR / SISTEMA HIDRÁULICO / HIDROSTÁTICO:** reemplace el filtro. Reemplace la cubierta del respiradero del depósito.
- **FILTRO DE ENTRADA DE LA VALVULA DE DIRECCIÓN (sólo en máquinas con sistema AWS):** reemplace el filtro.
- **CADA 1000 HORAS / MOTOR HIDROSTÁTICO (sólo en máquinas de tracción):** reemplace el fluido.
- **CADA 1000 HORAS / MOTOR HIDROSTÁTICO (sólo en máquinas de tracción):** reemplace el fluido.
- **DEPÓSITO HIDRÁULICO:** reemplace el fluido.
- **TRANSMISIÓN FINAL (sólo en las guardacadenas de máquinas con ruedas):** reemplace el fluido.
- **RODILLO DE TRACCIÓN, CONJUNTO DE RODILLOS AUXILIARES (sólo en máquinas de tracción):** reemplace el fluido (si corresponde).
- **FILTRO DE DRENAJE DE LA CAJA DEL MOTOR DE TRANSMISIÓN:** reemplace el filtro (si corresponde).
- **COJINETES DE LAS RUEDAS Y RANURAS EXTERIORES (sólo en máquinas con sistema AWS):** vuelva a untar grasa en los cojinetes de las ruedas y lubrique las ranuras externas en la horquilla del cubo. (Sólo servicio de mantenimiento del distribuidor)

DIAGRAMAS GENERALES DE LUBRICACIÓN

MÁQUINA DE TRAYECTORIA RADIAL

MÁQUINA DE TRAYECTORIA VERTICAL

MÁQUINA DE TRAYECTORIA VERTICAL

● PUNTOS DE ENGRASE HABITUALES

Utilice piezas originales
Bobcat de repuesto

NOTAS:

- Reemplace el elemento cuanto antes si el indicador de advertencia de la transmisión permanece encendido durante más de 5 minutos luego de que el fluido hidráulico haya alcanzado la temperatura de funcionamiento.
- Realice un servicio de mantenimiento después de las primeras 50 horas y, luego, según el programa.
- Consulte el Manual de funcionamiento y mantenimiento acerca de las especificaciones de fluidos, los números de piezas de filtro y las ubicaciones, así como la frecuencia apropiada para realizar el mantenimiento a su modelo de máquina.

CONSULTE EL MANUAL DE FUNCIONAMIENTO Y MANTENIMIENTO PARA OBTENER MÁS INFORMACIÓN E INSTRUCCIONES.

6734534E 06/19

73004 SYW

6734534E 06/19

SCHEMAS GÉNÉRAUX DE GRAISSAGE

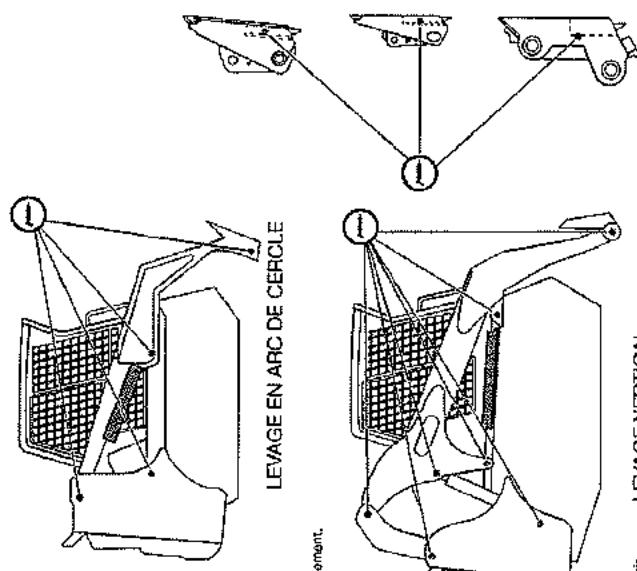

LEVAGE EN ARC DE CERCLE

LEVAGE VERTICAL

POINTS DE GRAISSAGE TYPIQUES



Utilisez des pièces de rechange
Boccal d'origine

73694 SSV

6734534E PCA
© 1998 BE (0001210001)

AVERTISSEMENT

- RISQUE DE BLESSURE OU DE MORT**
 - Gardez la porte fermée sauf pour des opérations d'entretien.
 - Débarrassez le moteur de tout matériau inflammable.
 - Maintenez le corps, les objets mobiles et les vêtements à l'écart des contacts électriques, des pièces mobiles, des pièces brûlantes et de l'échappement.
 - N'utilisez pas la chargeuse dans des lieux contenant des poussières ou des gaz explosifs ou avec des matériaux inflammables à proximité ou l'échappement.
 - N'utilisez jamais d'alcool ou de liquide d'aide au démarrage sur les moteurs diesel équipés de bougies de préchauffage.
 - Utilisez uniquement des aides au démarrage approuvées par le fabricant du moteur.
 - En cas de fuite, le liquide sous pression peut pénétrer dans la peau et provoquer des blessures graves.
 - Portez des lunettes de protection car l'acide contenu dans une batterie provoque des brûlures graves. En cas de contact d'acide sur les yeux, la peau ou les vêtements, rincez abondamment à l'eau. En cas de contact sur les yeux, rincez abondamment et consultez immédiatement un médecin.
 - La batterie génère des gaz inflammables et explosifs. Maintenez-la à l'écart des arcs, des étincelles, des flammes et des cigarettes allumées.
 - En cas de démarrage forcé, connectez le câble négatif au moteur de la chargeuse en dernier (jamais à la batterie). Après un démarrage forcé, retirez au premier la connexion négative au moteur.
 - Les gaz d'échappement peuvent être mortels. Veillez à toujours aérer la zone.

LISTE DE CONTRÔLE ET PÉRIODICITÉ DES ENTRETIENS

TOUTES LES 10 H (AVANT DE DÉMARRER LA CHARGEUSE)

- **HUILE ET FILTRE MOTEUR** - Vérifiez le niveau et faites le top-up si nécessaire. Ne dégraissez pas le réservoir irrigué. Changez l'huile et le filtre toutes les 50 premières heures, puis consultez le manuel d'utilisation et d'entretien pour connaître les intervalles de changement d'huile pour votre modèle.
 - **FILTRES À CARBONE** - Vérifiez l'état des filtres à charbon actif. Remplacez-les si nécessaire.
 - **CIRCUIT DE VENTILATION DU MOTEUR** - Vérifiez l'obstruction et l'état des éléments.
 - **CIRCUIT DE REFRIGÉRISEMENT DU MOTEUR** - Vérifiez le niveau de liquide de refroidissement à froid, faites l'appoint au besoin.
 - **FILTRE D'ALIMENTATION** - Remplacez-le tous les 50 h.
 - **BRAS DE LEVAGE DE LA CHARGEUSE, ARTICULATIONS DE LEVAGE, VERNIS, PIVOTS ET CALES DU BOB-TACH, VÉRINS DE DIRECTION** (machines à roues directrices uniquement) - Graissez avec une graisse à base de lithium.
 - **CEINTURE DE SÉCURITÉ, ARCADE DE SIÈGE ET VERROUILLAGE DES COMMANDES** - Vérifiez le bon fonctionnement. Réglez ou remplacez-les au besoin. Éliminez toute trace de saleté ou tout débris des pièces mobiles.
 - **BIGS** - Vérifiez son bon fonctionnement. Remplacez les saletés et les débris des pièces mobiles.
 - **SAVAGE NE DOIVENT PAS FONCTIONNER** lorsque l'arcade de siège est relevé.
 - **PRELUS** - Vérifiez la pression. Gonflez à la pression MAXIMALE indiquée sur la paroi du pneu.
 - **GÉNÉRAL** - Contrôlez toute pièce desserrée ou endommagée. Le bon état de la cabine de l'opérateur, le fonctionnement des instruments, le serrage des écrous de roues ou des écrous de gâchettes, les fuites d'huile, les autocollants abîmés ou manquants.
- TOUTES LES 50 H**
- **HUILE HYDRAULIQUE, FLEXIBLES ET CONDUITES** - Vérifiez le niveau d'huile et faites l'appoint le cas échéant. Vérifiez la présence de fuites ou de bulles. Effectuez les réparations ou les remplacements requis.
 - **TRANSMISSION PRVALE (CARTER DE CHAÎNE, machines sur roues uniquement)** - Vérifiez le niveau de liquide et faites l'appoint si nécessaire.
 - **COMMANDES HYDRAULIQUES ET DE DIRECTION (PÉDALES, POIGNÉE et/ou MANIVELATEUR)** - Vérifiez leur bon fonctionnement. Effectuez les réglages nécessaires.
 - **ÉCROUS DES PNEUS (MACHINES À CHAINES uniquement)** - Vérifiez la tension et effectuez les réglages nécessaires.
 - **TOUTES LES 100 H**
 - **SIL ENOUEUX PARE-ÉTINCELLES** - Vérifiez la chambre à étincelles (le cas échéant).
 - **BATTERIE** - Vérifiez l'état de la batterie, des brûleurs de chauffage, des câbles, des connexions et le niveau d'électrolyte. Ajoutez de l'eau distillée si nécessaire.
 - **CHAÎNE CINÉMATIQUE** - Graissez le raccord moteur/pompe avec de la graisse multi-usages à base de lithium (le cas échéant).
 - **TOUTES LES 250 H**
 - **PIVOTS DES LEVIERS DE DIRECTION** - Graissez avec de la graisse multi-usages à base de lithium (le cas échéant).
 - **FILTRE D'ALIMENTATION** - Remplacez le filtre.
 - **AXES DE FUSÉES** (machines à roues directrices uniquement) - Graissez avec de la graisse multi-usages à base de lithium.
 - **COUPROIE D'ENTRAÎNEMENT MOTEUR / HYDRAULIQUE** - Vérifiez que le couroie n'est ni usé ni déformé. Effectuez les réglages ou les remplacements requis (le cas échéant).
 - **BOUTE À ENGRÈGES DU VENTILATEUR** - Vérifiez le niveau d'huile et faites l'appoint si nécessaire (le cas échéant).
 - **AUTRES COURROIES D'ENTRAÎNEMENT** (pompes hydrostatiques, pompe à eau, alternateur et climatiseur - le cas échéant) - Vérifiez l'état et la tension. Effectuez les réglages ou les remplacements requis.
 - **BIGS** - Vérifiez le bon fonctionnement de la commande de débrayage des bras de levage.
- TOUTES LES 500 H**
- **VERTILATEUR / CIRCUIT HYDROSTATIQUE / HYDRAULIQUE** - Remplacez le filtre. Remplacez le bouchon renneid du réservoir.
 - **FILTRE RÉTICRÉ DU CLAPET DE DIRECTION** (modèles à roues directrices uniquement) - Remplacez le filtre.
 - **TOUTES LES VERTILATEUR HYDROSTATIQUE** (machines sur chenilles uniquement) - Remplacez l'huile.
 - **TOUTES LES 1000 H**
 - **RÉSÉRIEUSE** - Remplacez le filtre.
 - **TRAMMISSION FINALE** - Vérifiez le niveau de liquide et faites l'appoint si nécessaire.
 - **ENSEMBLES GALETS DE COURSE** (de chaînes, machines sur roues uniquement) - Remplacez l'huile.
 - **ENSEMBLES GALETS DE COURSE** (de chaînes, machines sur chenilles uniquement) - Remplacez-les si nécessaire.
 - **FILTRE DE RETOUR DE CARTER DU MOTEUR D'ENTRAÎNEMENT** - Remplacez le filtre (le cas échéant).
 - **BOULIEMENT DE ROUES ET CHAINES LIÈRES MÂLES** (modèles à roues directrices uniquement) - Graissez à froid les roulements de roues, graissez les cannelures femelles de la courroie (vérifiez par le concessionnaire uniquement).





REMARQUES :

- remplacez l'élément plus tôt si le témoin d'avertissement de la transmission reste allumé pendant plus de 5 minutes une fois que l'huile hydraulique a atteint la température de fonctionnement.
- Effectuez l'entretien après 50 heures, puis selon le tableau.
- Consultez le manuel d'utilisation et d'entretien pour les spécifications sur les fluides, le numéro de pièce et l'emplacement du filtre, et la procédure d'entretien appropriée pour votre modèle.

CONSULTEZ LE MANUEL D'UTILISATION ET D'ENTRETIEN POUR DES INSTRUCTIONS ET DES INFORMATIONS SUPPLÉMENTAIRES.

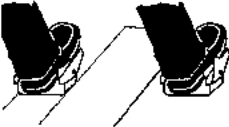
⚠ WARNING

AVOID INJURY OR DEATH

 <p>NEVER USE THE LOADER WITHOUT INSTRUCTIONS. READ OPERATION AND MAINTENANCE MANUAL AND HANDBOOK.</p>	 <p>USE SEAT BAR. FASTEN SEAT BELT SECURELY.</p>	 <p>KEEP FEET ON PEDALS.</p>	<p>TO LEAVE THE LOADER:</p> <div style="display: flex; justify-content: space-between;"> <div style="width: 48%;"> <p>1 </p> <p>LOWER THE LIFT ARMS. PUT ATTACHMENT FLAT ON GROUND.</p> </div> <div style="width: 48%;"> <p>2 </p> <p>STOP THE ENGINE.</p> </div> </div>
 <p>DO NOT TRAVEL OR TURN WITH LIFT ARMS UP. LOAD, UNLOAD AND TURN ON FLAT LEVEL GROUND. DO NOT EXCEED RATED OPERATING CAPACITY (SEE SIGN ON LOADER).</p>	 <p>NEVER MODIFY EQUIPMENT OR USE ATTACHMENTS NOT APPROVED BY MELROE COMPANY.</p>	 <p>ON SLOPES, KEEP HEAVY END OF LOADER UPHILL.</p>	<div style="display: flex; justify-content: space-between;"> <div style="width: 48%;"> <p>3 </p> <p>ENGAGE THE BRAKE.</p> </div> <div style="width: 48%;"> <p>4 </p> <p>RAISE SEAT BAR. MOVE PEDALS UNTL BOTH LOCK.</p> </div> </div> <p><small>Weitere Anweisungen finden sie in der Bedienung - und Instandhaltungsanleitung. Para más instrucciones, vea el Manual de Operación y Mantenimiento. Voir le Manuel de l'opérateur et d'entretien pour d'autres renseignements.</small></p>











⚠ ADVERTENCIA

EVITE LESIONES O LA MUERTE

 <p>NUNCA USE EL CARGADOR SIN LEER LAS INSTRUCCIONES. LEA EL MANUAL DE OPERACIÓN Y MANTENIMIENTO Y LA GUÍA.</p>	 <p>USE LA BARRA DEL ASIENTO. ABROCHÉSE BIEN EL CINTURÓN DE SEGURIDAD.</p>	 <p>MANTENGA LOS PIES EN LOS PEDALES.</p>	<p>ANTES DE BAJARSE DEL CARGADOR</p> <div style="display: flex; justify-content: space-between;"> <div style="width: 48%;"> <p>1 </p> <p>BAJE LOS BRAZOS DE ELEVACIÓN. COLOQUE EL IMPLEMENTO PLANO EN EL SUELO.</p> </div> <div style="width: 48%;"> <p>2 </p> <p>APAGUE EL MOTOR.</p> </div> </div>
 <p>NO VIAJE O GIRE CON LOS BRAZOS DE ELEVACIÓN ARRIBA. CARQUE, DESCARQUE Y GIRE EN UN SITO PLANO Y NIVELADO. NO EXCEDA LA CAPACIDAD NOMINAL OPERATIVA (VEA EL AVISO EN EL CARGADOR).</p>	 <p>NUNCA MODIFIQUE EL EQUIPO NI USE IMPLEMENTOS QUE NO ESTÉN APROBADOS POR MELROE COMPANY.</p>	 <p>EN LAS PENDIENTES, MANTENGA EL EXTREMO PESADO DEL CARGADOR EN POSICIÓN ASCENDENTE.</p>	<div style="display: flex; justify-content: space-between;"> <div style="width: 48%;"> <p>3 </p> <p>COLOQUE EL FRENO.</p> </div> <div style="width: 48%;"> <p>4 </p> <p>LEVANTE LA BARRA DEL ASIENTO. MUEVA LOS PEDALES HASTA QUE AMBOS SE ASEGUEN.</p> </div> </div> <p>Para más instrucciones, consulte el Manual de operación y mantenimiento.</p>

⚠ ATTENTION

EVITER LES BLESSURES OU LA MORT

 <p>NE VOUS SERVEZ JAMAIS DE LA CHARGEUSE SANS INSTRUCTIONS. LISEZ LE MANUEL DE L'OPÉRATEUR ET D'ENTRETIEN AINSI QUE LE GUIDE D'UTILISATION.</p>	 <p>UTILISEZ L'ARCEAU DE SÉCURITÉ. ATTACHEZ SOIGNEUSEMENT LA CEINTURE DE SÉCURITÉ.</p>	 <p>MANTENEZ LES PIEDS SUR LES PEDALES.</p>	<p>POUR QUITTER LA CHARGEUSE:</p> <div style="display: flex; justify-content: space-between;"> <div style="width: 48%;"> <p>1 </p> <p>ABAISSÉZ LES BRAS DE LEVAGE. POSEZ L'ÉQUIPEMENT À PLAT SUR LE SOL.</p> </div> <div style="width: 48%;"> <p>2 </p> <p>ARRÊTEZ LE MOTEUR.</p> </div> </div>
 <p>NE PAS SE DÉPLACER NI VIRER AVEC LES BRAS LÉVÉS. CHARGEZ, DÉCHARGEZ ET VIREZ SUR UN SOL PLAT ET HORIZONTAL. NE DÉPASSEZ PAS LA CAPACITÉ OPÉRATIONNELLE.</p>	 <p>NE JAMAIS MODIFIER L'ÉQUIPEMENT NI SE SERVIR D'ACCESSOIRES QUI NE SONT PAS APPROUVÉS PAR DOBACAT.</p>	 <p>DANS LES PENTES, MANTENEZ TOUJOURS LA PARTIE LA PLUS LOURDE DE LA CHARGEUSE VERS LE HAUT.</p>	<div style="display: flex; justify-content: space-between;"> <div style="width: 48%;"> <p>3 </p> <p>ENLEVEZ LE FREIN DE STATIONNEMENT.</p> </div> <div style="width: 48%;"> <p>4 </p> <p>RELEVEZ L'ARCEAU DE SIÈGE. DÉPLACEZ LES PEDALES JUSQU'À CE QU'ELLES SOIENT TOUTES DEUX VERROUILLÉES.</p> </div> </div> <p><small>Weitere Anweisungen finden sie in der Bedienung - und Instandhaltungsanleitung. Para más instrucciones, vea el Manual de Operación y Mantenimiento. Voir le Manuel de l'opérateur et d'entretien pour d'autres renseignements.</small></p>

MACHINE SIGN TRANSLATIONS (CONT'D)

Danger (6702301)

	⚠ DANGER
	<p>AVOID DEATH</p> <ul style="list-style-type: none"> Attachment can be forced against the ground and cause front wheels to raise. Never go under or reach under lift arms or lift cylinder without an approved lift arm support device installed. <p style="font-size: small;">67116 SW 6702301D enUS</p>

	⚠ PELIGRO
	<p>EVITE ACCIDENTES FATALES</p> <ul style="list-style-type: none"> El implemento puede ser forzado contra el suelo y causar la elevación de los neumáticos delanteros. Jamás pase ni se estire por debajo de los brazos de elevación o del cilindro de elevación sin un dispositivo de soporte aprobado instalado. <p style="font-size: small;">67116 SW 6702301D enUS</p>

	⚠ DANGER
	<p>EVITER LA MORT</p> <ul style="list-style-type: none"> L'accessoire peut être appuyé contre le sol et soulever les roues avant. Ne jamais aller sous ni mettre les mains sous les bras ou le verin de levage sans qu'un arrêt de bras de levage approuvé soit installé. <p style="font-size: small;">67116 SW 6702301D enUS</p>

Danger (6702302)

⚠ DANGER	
<p>AVOID DEATH</p> <ul style="list-style-type: none"> Keep out of this area when lift arms are raised unless supported by an approved lift arm support device. Moving lift arm control or failure of a part can cause lift arms to drop. <p style="font-size: small;">62554 SW 6702302F enUS</p>	

⚠ PELIGRO	
<p>EVITE MUERTES</p> <ul style="list-style-type: none"> Manténgase alejado del área cuando los brazos de elevación estén elevados, a menos que cuenten con un dispositivo de sostén aprobado. Si se mueve el control de los brazos de elevación o si falla alguna de las piezas, es posible que éstos se caigan. <p style="font-size: small;">62554 SW 6702302F enAR</p>	

⚠ DANGER	
<p>RISQUE MORTEL</p> <ul style="list-style-type: none"> Restez à l'écart de cette zone lorsque les bras de levage sont relevés sauf s'ils sont soutenus par un arrêt approuvé. Le déplacement d'une commande de bras de levage ou la défaillance d'une pièce peut provoquer la chute des bras de levage. <p style="font-size: small;">62554 SW 6702302F enCA</p>	

Danger (6717343)

⚠ DANGER	
<p>AVOID DEATH</p> <ul style="list-style-type: none"> Disconnecting or loosening any hydraulic tubeline, hose, fitting, component or a part failure can cause lift arms to drop. Keep out of this area when lift arms are raised unless supported by an approved lift arm support. Replace if damaged. <p style="font-size: small;">67116 SW 6717343A enUS</p>	

⚠ PELIGRO	
<p>EVITE MUERTES</p> <ul style="list-style-type: none"> Si se desconecta o afloja algún tubo, manguera, accesorio o componente hidráulico, o si falla alguna de las piezas, es posible que los brazos de elevación se caigan. Manténgase alejado del área cuando los brazos de elevación estén elevados, a menos que cuenten con un dispositivo de sostén aprobado. Si se encuentran dañados, cámbielos. <p style="font-size: small;">67116 SW 6717343A enAR</p>	

⚠ DANGER	
<p>RISQUE MORTEL</p> <ul style="list-style-type: none"> Le débranchement ou le desserrage de conduites, raccords, tuyaux ou composants hydrauliques ou une pièce hydraulique défectueuse peuvent entraîner une chute des bras de levage. Restez éloigné de la zone où les bras de levage sont relevés, sauf s'ils sont maintenus par un arrêt de bras de levage approuvé. Remplacez-le en cas de dommages. <p style="font-size: small;">67116 SW 6717343A enCA</p>	

Warning (6579528)

	⚠ WARNING
	<p>AVOID INJURY OR DEATH</p> <p>CARRY LOAD LOW</p> <p>FAILURE TO OBEY CAN CAUSE TIPPING OR ROLLOVER OR LOSS OF LOAD OR VISIBILITY.</p> <p style="font-size: small;">62702 SW 6579528C enUS</p>

	⚠ ADVERTENCIA
	<p>EVITE LESIONES O LA MUERTE</p> <p>LLEVE LA CARGA BAJA</p> <p>EL INCUMPLIMIENTO PUEDE PROVOCAR TRASTORNOS, VUELCO, PERDIDA DE LA CARGA O DE LA VISIBILIDAD.</p> <p style="font-size: small;">62702 SW 6579528C enAR</p>

	⚠ AVERTISSEMENT
	<p>RISQUE DE BLESSURE OU DE MORT</p> <p>GARDEZ LA CHARGE PRÈS DU SOL</p> <p>LE NON RESPECT PEUT ENTRÂNER UN BASCULEMENT, UN TONNEAU OU UNE PERTE DE VISIBILITÉ OU DE LA CHARGE.</p> <p style="font-size: small;">62702 SW 6579528C enCA</p>

MACHINE SIGN TRANSLATIONS (CONT'D)

Lift Arm Support Device (6711659)

- TO ENGAGE LIFT ARM SUPPORT DEVICE**
1. Remove attachment from loader.
 2. Unhook spring from pin. Hold lift arm support device. Remove pin.
 3. Lower the lift arm support device to the top of the cylinder.
 4. Hook spring into slot on top of lift arm support device.
 5. Enter loader, fasten seat belt, lower seat bar and start engine.
 6. Raise lift arms until lift arm support device drops on cylinder rod.
 7. Lower lift arms slowly until movement stops.
 8. Stop engine. Raise seat bar. Move pedals until both pedals lock. Leave loader.
 9. Install pin into rear of lift arm support device below cylinder rod.

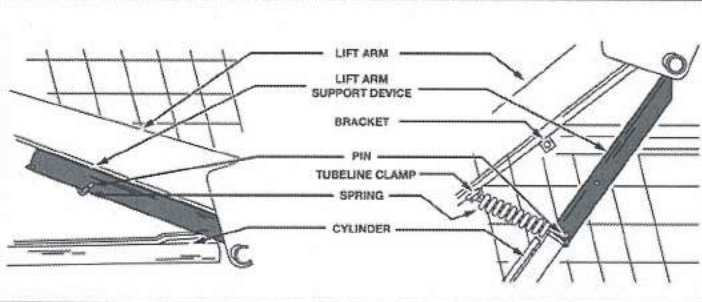

- TO DISENGAGE LIFT ARM SUPPORT DEVICE**
1. Remove pin.
 2. Hook spring into tubeline clamp below lift arm.
 3. Enter loader, fasten seat belt, lower seat bar and start engine.
 4. Raise lift arms until lift arm support device raises off cylinder rod.
 5. Lower lift arms. Stop engine. Raise seat bar. Move pedals until both pedals lock. Leave loader.
 6. Unhook spring from tubeline clamp.
 7. Raise lift arm support device to storage position.
 8. Insert pin through lift arm support device and bracket.
 9. Hook spring to pin.

67101 SW 6711659-0000

- CÓMO ENGANCHAR EL DISPOSITIVO DE SOSTÉN DEL BRAZO DE ELEVACIÓN**
1. Retire el accesorio de la cargadora.
 2. Desenganche el resorte de la clavija. Sostenga el dispositivo de sostén del brazo de elevación. Retire la clavija.
 3. Baje el dispositivo de sostén del brazo de elevación hasta la parte superior del cilindro.
 4. Enganche el resorte en la ranura sobre la parte superior del dispositivo de sostén del brazo de elevación.
 5. Ingrese a la cargadora, ajústese el cinturón de seguridad, baje la barra del asiento y encienda el motor.
 6. Eleve los brazos de elevación hasta que el dispositivo de sostén del brazo de elevación caiga sobre la varilla del cilindro.
 7. Baje los brazos de elevación lentamente hasta que el movimiento se detenga.
 8. Detenga el motor. Eleve la barra del asiento. Mueva los pedales hasta que ambos se bloqueen. Retírese de la cargadora.
 9. Instale la clavija en la parte trasera del dispositivo de sostén del brazo de elevación debajo de la varilla del cilindro.

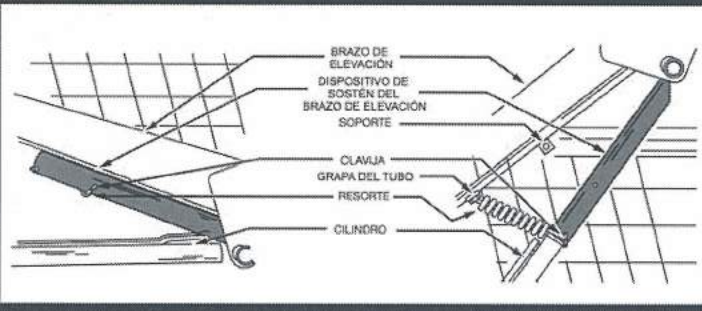

- CÓMO DESENGANCHAR EL DISPOSITIVO DE SOSTÉN DEL BRAZO DE ELEVACIÓN**
1. Retire la clavija.
 2. Enganche el resorte en la grapa del tubo que se encuentra por debajo del brazo de elevación.
 3. Ingrese a la cargadora, ajústese el cinturón de seguridad, baje la barra del asiento y encienda el motor.
 4. Eleve los brazos de elevación hasta que el dispositivo de sostén del brazo de elevación se eleve fuera de la varilla del cilindro.
 5. Baje los brazos de elevación. Detenga el motor. Eleve la barra del asiento. Mueva los pedales hasta que ambos se bloqueen. Retírese de la cargadora.
 6. Desenganche el resorte de la grapa del tubo.
 7. Eleve el dispositivo de sostén del brazo de elevación a la posición de almacenamiento.
 8. Introduzca la clavija a través del dispositivo de sostén del brazo de elevación y el soporte.
 9. Enganche el resorte a la clavija.

67101 SW 6711659-0000

- ENCLÈNCHÈMENT DE L'ARRÊTOIR DE BRAS DE LEVAGE**
1. Retirez l'accessoire de la chargeuse.
 2. Débranchez le ressort de la goupille. Tenez l'arrêt de bras de levage. Retirez la goupille.
 3. Abaissez l'arrêt de bras de levage jusqu'à la partie supérieure du vérin.
 4. Accrochez le ressort en le passant dans la fente sur l'arrêt de bras de levage.
 5. Prenez place dans la chargeuse, bouclez la ceinture, abaissez l'arcade de siège et mettez le moteur en marche.
 6. Relevez les bras de levage jusqu'à ce que l'arrêt de bras de levage tombe sur la tige du vérin.
 7. Abaissez lentement les bras de levage jusqu'à ce qu'ils s'arrêtent.
 8. Arrêtez le moteur. Relevez l'arcade de siège. Bougez les pédales jusqu'à ce qu'elles se verrouillent. Quittez la chargeuse.
 9. Installez la goupille à l'arrière de l'arrêt de bras de levage sous la tige du vérin.

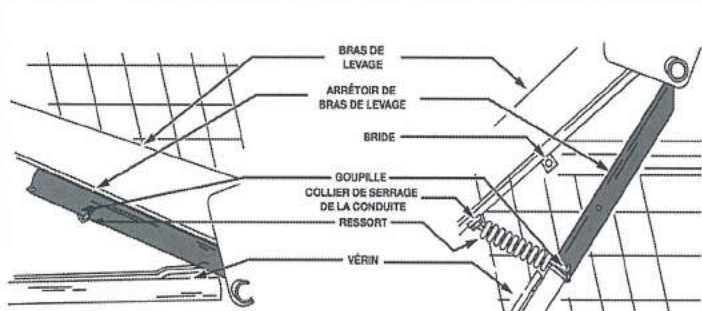

- DÉSENCLÈNCHÈMENT DE L'ARRÊTOIR DE BRAS DE LEVAGE**
1. Retirez la goupille.
 2. Accrochez le ressort au collier de la conduite sous le bras de levage.
 3. Prenez place dans la chargeuse, bouclez la ceinture, abaissez l'arcade de siège et mettez le moteur en marche.
 4. Relevez les bras de levage jusqu'à ce que l'arrêt de bras de levage s'éloigne de la tige du vérin.
 5. Abaissez les bras de levage. Arrêtez le moteur. Relevez l'arcade de siège. Bougez les pédales jusqu'à ce qu'elles se verrouillent. Quittez la chargeuse.
 6. Débranchez le ressort du collier de la conduite.
 7. Relevez l'arrêt de bras de levage en position de rangement.
 8. Insérez la goupille dans l'arrêt de bras de levage et la bride.
 9. Accrochez le ressort à la goupille.

67101 SW 6711659-0000

Danger (7170355)

			<p>7170355-0000 DANGER</p>		<p>⚠ DANGER AVOID DEATH</p> <ul style="list-style-type: none"> • Disconnecting hydraulic lines can cause the lift arms or attachment to drop. • Always use an approved lift arm support when lift arms are in a raised position. 	
			<p>7170355-0000 PELIGRO</p>		<p>⚠ PELIGRO EVITE MUERTES</p> <ul style="list-style-type: none"> • Si se desconectan las líneas hidráulicas, es posible que los brazos de elevación o los accesorios se caigan. • Utilice siempre un dispositivo de sostén aprobado de los brazos de elevación cuando éstos estén elevados. 	
			<p>7170355-0000 DANGER</p>		<p>⚠ DANGER RISQUE MORTEL</p> <ul style="list-style-type: none"> • Le débranchement des conduites hydrauliques peut provoquer la chute des bras de levage ou de l'accessoire. • Utilisez toujours un arrêt de bras de levage approuvé lorsque les bras sont en position relevée. 	

MACHINE SIGN TRANSLATIONS (CONT'D)

Warning (6737189)

WARNING

THIS VEHICLE IS EQUIPPED WITH A BACK-UP ALARM.
ALARM MUST SOUND!
 WHEN OPERATING THIS VEHICLE IN REVERSE.
 FAILURE TO MAINTAIN A CLEAR VIEW
 IN THE DIRECTION OF TRAVEL COULD
 RESULT IN SERIOUS INJURY OR DEATH.
 THE OPERATOR IS RESPONSIBLE FOR
 THE SAFE OPERATION OF THIS VEHICLE.

71848 SW 6737189B enUS
ESTE VEHICULO ESTÁ EQUIPADO CON UNA ALARMA DE ALERTA DE RETROCESO

ADVERTENCIA

ESTE VEHÍCULO ESTÁ EQUIPADO CON UNA ALARMA DE ALERTA DE RETROCESO
¡LA ALARMA DEBE SONAR!
 CUANDO RETROCEDA ESTE VEHÍCULO.
 NO MANTENER UNA VISTA CLARA EN LA DIRECCIÓN DONDE VIAJA PUEDE RESULTAR EN LESIONES GRAVES O FATALIDADES.
 EL OPERADOR ES RESPONSABLE DE LA OPERACIÓN SEGURA DE ESTE VEHÍCULO.

71848 SW 6737189B ar
ESTE VEHICULO ESTÁ EQUIPADO CON UNA ALARMA DE ALERTA DE RETROCESO

ADVERTISSEMENT

CE VÉHICULE EST ÉQUIPÉ D'UNE ALARME DE REcul.
L'ALARME DOIT FONCTIONNER !
 LORSQUE VOUS UTILISEZ CE VÉHICULE EN MARCHÉ ARRIÈRE.
 NE PAS AVOIR UNE VUE DÉGAGÉE DANS LE SENS DE LA MARCHÉ PEUT ENTRAÎNER DES BLESSURES GRAVES, VOIRE MORTELLES.
 L'OPÉRATEUR EST RESPONSABLE DE LA SÉCURITÉ LORS DE L'UTILISATION DE CE VÉHICULE.

71848 SW 6737189B fr
CE VEHICULE EST EQUIPE D'UNE ALARME DE REcul

Warning (6804233)

WARNING

- Hot pressurized fluid.
- Can cause serious burns.

39894 SW 6804233

ADVERTENCIA

- Fluido presurizado caliente.
- Puede provocar quemaduras graves.

39894 SW 6804233 AR

AVERTISSEMENT

- Fluide chaud sous pression.
- Peut gravement brûler.

39894 SW 6804233 frCA

Warning (6576048)

 **WARNING**

KEEP FINGERS AND OBJECTS AWAY FROM FAN.

4324 SW 6576048

 **ADVERTENCIA**

EVITE LESIONES MANTENGA LOS DEDOS Y OBJETOS ALEJADOS DEL VENTILADOR.

4324 SW 6576048 AR

 **AVERTISSEMENT**

GARDEZ LES DOIGTS ET LES OBJETS À DISTANCE DU VENTILATEUR.

4324 SW 6576048 frCA

Important (6732775)

IMPORTANT

Disconnect heater hose quick couplers before raising operator cab.

55941 SW 02 6732775

IMPORTANTE

Desconecte los acopladores rápidos de la manguera del calefactor antes de elevar la cabina del operador.

55941 SW 6732775 esAR

IMPORTANT

Déconnectez les coupleurs rapides du tuyau du chauffage avant de relever la cabine de l'opérateur.

55941 SW 6732775 frCA

MACHINE SIGN TRANSLATIONS (CONT'D)

Warning (6565491)

⚠ WARNING

AVOID INJURY OR DEATH

Before lifting loader, check the hardware and fasteners of the single point lift and the operator's cab (ROPS).

Operator cab (ROPS) fasteners must be assembled as shown. See Operation & Maintenance Manual for assembly of the single point lift.

Never allow riders in operator cab (ROPS) during lifting of loader.

Keep 15 feet (5 meters) away from loader while lifting.

23619 SW 6565491

⚠ ADVERTENCIA

EVITE LESIONES O LA MUERTE

Antes de levantar la cargadora, verifique los herrajes y sujetadores del punto único de elevación y la cabina del operador (ROPS, Estructura protectora de vuelcos).

Los sujetadores de la cabina del operador (ROPS) se deben montar según se indica aquí. Consulte el Manual de funcionamiento y mantenimiento para obtener instrucciones acerca del montaje del punto único de elevación.

No permita que los ocupantes ingresen a la cabina del operador (ROPS) durante la elevación de la cargadora.

Manténgase a 15 pies (5 metros) de distancia de la cargadora durante la elevación.

23619 SW 6565491 ar

⚠ AVERTISSEMENT

RISQUE DE BLESSURE OU DE MORT

Avant de soulever la chargeuse, vérifiez la visserie de fixation et les fixations de l'ensemble de levage à point unique et la cabine de l'opérateur (ROPS).

Les fixations de la cabine de l'opérateur (ROPS) doivent être montées comme il est illustré. Consultez le manuel d'utilisation et d'entretien pour le montage de l'ensemble de levage à point unique.

Personne ne doit se trouver dans la cabine (ROPS) lors du levage de la chargeuse.

Toutes les personnes doivent rester à au moins 5 mètres (15 pi) de la chargeuse pendant le levage.

23619 SW 6565491 frCA

Important (6560573)

IMPORTANT

THIS MACHINE IS FACTORY EQUIPPED WITH A U.S.D.A. FORESTRY SERVICE APPROVED SPARK ARRESTOR EXHAUST SYSTEM.

THE SPARK ARRESTOR MUFFLER, IF EQUIPPED, MUST BE CLEANED TO KEEP IT IN WORKING CONDITION. THE SPARK ARRESTOR MUFFLER MUST BE SERVICED BY DUMPING THE SPARK CHAMBER EVERY 100 HRS OF OPERATION.

ON SOME MODELS, THE TURBOCHARGER FUNCTIONS AS THE SPARK ARRESTOR AND MUST OPERATE CORRECTLY FOR PROPER SPARK ARRESTOR FUNCTION.

IF THIS MACHINE IS OPERATED ON FLAMMABLE FOREST, BRUSH, OR GRASS COVERED LAND, IT MUST BE EQUIPPED WITH A SPARK ARRESTOR ATTACHED TO THE EXHAUST SYSTEM AND MAINTAINED IN WORKING ORDER. FAILURE TO DO SO WILL BE IN VIOLATION OF CALIFORNIA STATE LAW, SECTION 4442. PRC. REFER TO LOCAL LAWS AND REGULATIONS FOR SPARK ARRESTOR REQUIREMENTS.

SEE THE OPERATION AND MAINTENANCE MANUAL FOR MORE INSTRUCTIONS.

62554 SW 6560573G enUS

IMPORTANTE

ESTA MÁQUINA ESTÁ EQUIPADA DE FÁBRICA CON UN SILENCIADOR DEL SISTEMA PARACHISPAS APROBADO POR EL SERVICIO DE SILVICULTURA DE LA U.S.D.A.

EL SILENCIADOR DEL SISTEMA PARACHISPAS, SI ESTÁ EQUIPADO, DEBE LIMPIARSE PARA MANTENERSE EN CONDICIONES DE TRABAJO, ASÍ MISMO, SE LE DEBE DAR SERVICIO VACIANDO LA CÁMARA DE CHISPAS CADA 100 HORAS DE OPERACIÓN.

EN ALGUNOS MODELOS, EL TURBOCARGADOR FUNCIONA COMO EL PARACHISPAS Y DEBE OPERAR CORRECTAMENTE COMO TAL.

SI VA A OPERAR ESTA MÁQUINA EN BOSQUES INFLAMABLES O EN TERRENOS CUBIERTOS DE RAMAS O CÉSPED, DEBE DISPONER DE UN SISTEMA PARACHISPAS EN EL SISTEMA DE ESCAPE Y MANTENERLO EN BUENAS CONDICIONES DE TRABAJO. NO CUMPLIR ESTA ADVERTENCIA INFRINGIRÁ LA SECCIÓN 442 DE LA LEY DEL ESTADO DE CALIFORNIA. CONSULTE LAS LEYES Y REGLAMENTOS LOCALES ACERCA DE LOS REQUERIMIENTOS PARA UTILIZAR SISTEMAS PARACHISPAS.

PARA MAYORES INSTRUCCIONES, CONSULTE EL MANUAL DE OPERACIÓN Y MANTENIMIENTO.

62554 SW 6560573G enUS

IMPORTANT

CETTE MACHINE EST ÉQUIPÉE EN USINE D'UN SYSTÈME D'ÉCHAPPEMENT PARE-ÉTINCELLES APPROUVÉ PAR LE SERVICE AMÉRICAIN DES EAUX ET FORÊTS (U.S.D.A. FORESTRY SERVICE).

LE CAS ÉCHÉANT, LE SILENCIEUX PARE-ÉTINCELLES DOIT ÊTRE ENTRETENU POUR ASSURER SON BON FONCTIONNEMENT. CET ENTRETIEN CONSISTE À REMPLACER LA CHAMBRE À ÉTINCELLES TOUTES LES 100 HEURES D'EXPLOITATION.

SUR CERTAINS MODÈLES, LA FONCTION DE PARE-ÉTINCELLES EST ASSURÉE PAR LE TURBOCOMPRESSEUR QUI DOIT FONCTIONNER CORRECTEMENT POUR REMPLIR SA FONCTION.

SI VOUS UTILISEZ LA MACHINE EN FORÊT, SUR TERRAIN HERBEUX OU DANS DES TAILLIS, VOUS DEVEZ ÉQUIPER LE SYSTÈME D'ÉCHAPPEMENT D'UN PARE-ÉTINCELLES ET LE GARDER EN BON ÉTAT DE FONCTIONNEMENT. LE NON RESPECT DE CETTE OBLIGATION CONTREVIENT À LA LOI DE L'ÉTAT DE CALIFORNIE, SECTION 4442 PRC. VEUILLEZ VOUS RÉFÉRER AUX LOIS ET RÉGLEMENTS LOCAUX POUR CONNAÎTRE LES EXIGENCES EN MATIÈRE DE PARE-ÉTINCELLES.

VEUILLEZ CONSULTER LE MANUEL DE L'OPÉRATEUR ET D'ENTRETIEN POUR DES INSTRUCTIONS COMPLÉMENTAIRES.

62554 SW 6560573G enUS

MACHINE SIGN TRANSLATIONS (CONT'D)

Warning (6710358)

⚠ WARNING



AVOID INJURY OR DEATH

- Never carry riders.
- Never use loader as a man lift or work platform.

62702 SW 6710358B enUS

⚠ ADVERTENCIA



EVITE LESIONES O LA MUERTE

- Nunca lleve ocupantes.
- Nunca utilice la cargadora para levantar personas o como plataforma de trabajo.

62702 SW 6710358B esAR

⚠ AVERTISSEMENT



RISQUE DE BLESSURE OU DE MORT

- Ne transportez jamais de passagers.
- N'utilisez jamais la chargeuse comme élévateur pour le personnel ou comme plateforme de travail.

62702 SW 6710358B frCA

Warning (6702255)

⚠ WARNING



AVOID INJURY OR DEATH
SEE OPERATION & MAINTENANCE OR SERVICE MANUAL FOR INSTRUCTIONS TO:

- BLOCK UP LOADER
- LIFT AND LOWER THE CAB

6702255

⚠ ADVERTENCIA



EVITE LESIONES O LA MUERTE
CONSULTE EL MANUAL DE OPERACIÓN Y MANTENIMIENTO O DE SERVICIO PARA OBTENER MÁS INSTRUCCIONES SOBRE CÓMO:

- BLOQUEAR EL CARGADOR.
- SUBIR Y BAJAR LA CABINA.

27966 SW 00 6702255 AR

⚠ ATTENTION



EVITER LES BLESSURES OU LA MORT
VOIR LE MANUEL DE L'OPERATEUR OU LE MANUEL D'ATELIER CONCERNANT:

- LE BLOCAGE DE LA CHARGEUSE.
- LE LEVAGE ET L'ABAISSEMENT DE LA CABINE.

27966 VM-00-6702255-FR

MACHINE SIGN TRANSLATIONS (CONT'D)

Warning (6577754)



WARNING

**CYLINDER CONTAINS HIGH PRESSURE GAS. DO NOT OPEN. OPENING CYLINDER
CAN RELEASE ROD AND CAUSE INJURY OR DEATH.**

6577754



ADVERTENCIA

**EL CILINDRO CONTIENE GAS DE ALTA PRESIÓN. NO LO ABRA. SI SE ABRE EL CILINDRO, SE
PUEDE LIBERAR EL VÁSTAGO Y SE PUEDEN OCASIONAR LESIONES O LA MUERTE.**

29779

SW 6577754 AR



AVERTISSEMENT

**LES VERINS RENFERMENT UN GAZ SOUS PRESSION. N'OUVREZ JAMAIS UN VERIN, SOUS PEINE DE VOIR S'ÉCHAPPER
BRUTALEMENT LA TIGE, CAUSANT AINSI DES BLESSURES GRAVES, VOIRE MORTELLES.**

DV-99-6577754-FR

SPECIFICATIONS

(S70) LOADER SPECIFICATIONS	129
Machine Dimensions	129
Performance	130
Engine	130
Drive System	130
Controls	131
Hydraulic System	131
Electrical	132
Capacities	132
Tires	132



Bobcat®

(S70) LOADER SPECIFICATIONS

Machine Dimensions

- Dimensions are given for loader equipped with standard tires and 36 in. dirt bucket and may vary with other bucket types.
- Where applicable, specification conform to SAE or ISO standards and are subject to change without notice.

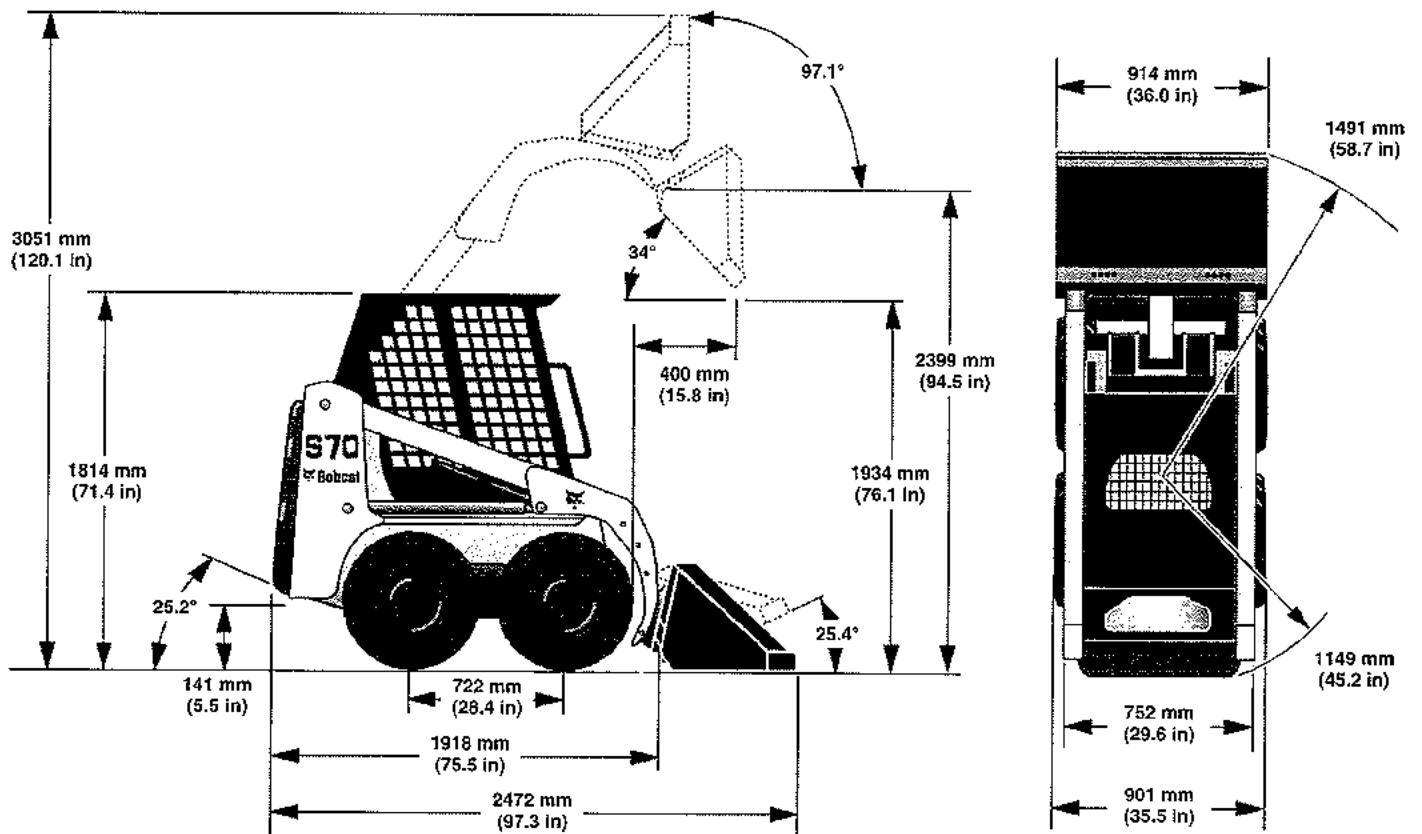

B-20824D

Changes of structure or weight distribution of the loader can cause changes in control and steering response and can cause failure of the loader parts.

(S70) LOADER SPECIFICATIONS (CONT'D)

Performance

Rated Operating Capacity	318 kg (700 lb)
Tipping Load	686 kg (1512 lb)
Operating Weight	1268 kg (2795 lb)
SAE Breakout Force - Lift - Tilt	8607 N (1935 lb) 8674 N (1950 lb)
Travel Speed	0 - 9,8 km/h (0 - 6.1 mph)
Push Force	9519 N (2140 lb)

Engine

Make / Model: - A3W611001 & Above - A3W711001 & Above - B38V11001 & Above	Kubota / D1005-E3B-BC-3 Tier 4 Kubota / D1005-E3B-BC-3 Tier 4 Kubota / D1005-E4B-BC-3 Tier 4 NRTC
Fuel / Cooling	Diesel / Liquid
Horsepower: - ISO 9249 / SAE J1349 Net - ISO 14396 - SAE J1995 Gross	16,8 kW (22.5 hp) @ 3000 rpm 17,2 kW (23.1 hp) @ 3000 rpm 17,5 kW (23.5 hp) @ 3000 rpm
Torque (SAE J1349 Gross)	62,8 N•m (45.6 ft-lb) @ 2200 rpm
Number of Cylinders	Three
Displacement	1001,0 cm ³ (61.08 in ³)
Bore / Stroke	76,0 mm / 73,6 mm (2.99 in / 2.90 in)
Lubrication	Gear Pump Pressure System with Filter
Crankcase Ventilation	Closed Breathing
Air Cleaner	Dry replaceable paper cartridge with separate safety element
Ignition	Diesel Compression
Air Induction	Naturally Aspirated
Low Idle	1125 - 1175 rpm
High Idle	3125 - 3175 rpm
Engine Coolant	Propylene Glycol / Water Mixture

Drive System

Main Drive	Hydrostatic 4 wheel drive
Transmission	Infinitely variable tandem hydrostatic piston pumps, driving two fully reversing hydrostatic motors.
Final Drive	Pre-stressed #60 HS endless roller chain (no master link) and sprockets in sealed chaincase with oil lubrication (Chains do not require periodic adjustments) Two chains per side with no idler sprocket
Total Engine to Wheel Reduction	31.25:1
Axle Size	37,6 mm (1.50 in), Heat treated
Wheel Bolts	Five - 9/16 in. Wheel bolts fixed to axle hubs

(S70) LOADER SPECIFICATIONS (CONT'D)**Controls**

Vehicle Steering	Direction and speed controlled by two hand operated steering levers.
Loader Hydraulics - Lift and Tilt	Controlled by separate foot pedals.
- Front Auxiliary Hydraulics (Std.)	Controlled by lateral movement of the right hand steering lever.
Engine	Hand lever speed control, key type start switch or optional keyless start, and optional engine shutdown (Rental Kit).
Starting Aid	Glow Plug - Automatically activated by Key Switch or Keyless instrumentation.
Service Brake	Two independent hydrostatic systems controlled by two hand operated steering levers.
Secondary Brake	One of the hydrostatic transmissions.
Parking Brake (Standard)	Mechanical disc, manually operated switch on front instrument panel.

Hydraulic System

Pump Type	Engine driven gear type
Pump Capacity	33,7 L/min (8.9 U.S. gpm) @ 3150 engine rpm
Filters	Full flow replaceable, 10 micron synthetic media element
System Relief at Quick Couplers	20,7 MPa (207 bar) (3000 psi)
Hydraulic Cylinders	Double acting; Tilt cylinder has cushioning feature on dump and rollback
Bore Diameter: Lift Cylinder (2)	50,8 mm (2.00 in)
Tilt Cylinder (1)	76,2 mm (3.00 in)
Rod Diameter: Lift Cylinder (2)	31,8 mm (1.25 in)
Tilt Cylinder (1)	31,8 mm (1.25 in)
Stroke: Lift Cylinder (2)	555,5 mm (21.87 in)
Tilt Cylinder (1)	268,2 mm (10.56 in)
Control Valve	3-Spool, open center type with spring detent for lift float and detent auxiliary hydraulic spool
Fluid Lines	SAE standard tubelines, hoses and fittings.
Fluid Type	BOBCAT FLUID, Hydraulic / Hydrostatic 6903117 - (2.5 U.S. gal) 6903118 - (5 U.S. gal) 6903119 - (55 U.S. gal)
Hydraulic Function Time:	
Raise Lift Arms	3.6 Seconds
Lower Lift Arms	2.7 Seconds
Bucket Dump	2.1 Seconds
Bucket Rollback	1.7 Seconds

(S70) LOADER SPECIFICATIONS (CONT'D)

Electrical

Alternator	Belt driven, 65 amperes ventilated
Battery	12 volt, 600 cold cranking amperes @ -18°C (0°F) 115 minute reserve capacity at 25 amperes
Starter	12 volt, gear type, 2,7 kW (3.62 hp)
Instrumentation	Gauges: Hourmeter, Engine Coolant Temperature, Voltmeter, and Fuel Level (on tank). Warning lights: Engine Warning, Transmission Warning, and Seat Belt. Indicators: BICS™ Functions.

Capacities

Engine Cooling System	5,7 L (6.0 qt)
Fuel	24,6 L (6.5 U.S. gal)
Engine Lubrication with Filter	3,7 L (3.9 qt)
Hydraulic / Hydrostatic Reservoir	5 L (5.3 qt)
Hydraulic / Hydrostatic System	15,1 L (4.0 U.S. gal)
Chaincase Reservoir	11,4 L (3.0 U.S. gal)

Tires

Standard Duty (Standard)	23 x 5.70 - 12, 4 Ply Rating
Heavy Duty (Option)	23 x 8.50 - 12, 6 Ply Rating
Recommended Pressure	Inflate tires to MAXIMUM pressure shown on the side wall of the tire. DO NOT mix brands of tires used on the same loader.

WARRANTY

WARRANTY135



Bobcat®

WARRANTY

Bobcat Loaders

Bobcat Company warrants to its authorized dealers and authorized dealers of Bobcat Equipment Ltd., who in turn warrant to the owner, that each new Bobcat loader will be free from proven defects in material and workmanship with respect to (i) all components of the product except as otherwise specified herein for twelve (12) months, (ii) the drive belt from the hydrostatic pump to the engine, for thirty six (36) months, provided that after the initial twelve month warranty period, such warranty shall be limited to parts only and does not include labor, (iii) tracks and Bobcat brand tires, for twelve (12) months on a prorated basis based on the remaining depth of the track or tire at the time any defect is discovered, and (iv) Bobcat brand batteries, for an additional twelve (12) months after the initial twelve month warranty period, provided that Bobcat Company shall only reimburse a fixed portion of the cost of replacing the battery during such additional twelve months. The foregoing time periods shall all commence after delivery by the authorized Bobcat dealer to the original buyer.

During the warranty period, the authorized Bobcat dealer shall repair or replace, at Bobcat Company's option, without charge for parts and labor, any part of the Bobcat product except as otherwise specified herein which fails because of defects in material or workmanship. The owner shall provide the authorized Bobcat dealer with prompt written notice of the defect and allow reasonable time for repair or replacement. Bobcat Company may, at its option, require failed parts to be returned to the factory. Travel time of mechanics and transportation of the Bobcat product to the authorized Bobcat dealer for warranty work are the responsibility of the owner. The remedies provided in this warranty are exclusive.

This warranty does not apply to diesel engine fuel injection pumps and injectors or tires (except Bobcat brand tires). The owner shall rely solely on the warranty, if any, of the respective manufacturers thereof. This warranty does not cover replacement of scheduled service items such as oil, filters, tune-up parts, and other high-wear items. This warranty does not cover damages resulting from abuse, accidents, alterations, use of the Bobcat product with any accessory or attachment not approved by Bobcat Company, air flow obstructions, or failure to maintain or use the Bobcat product according to the instructions applicable to it.

THIS WARRANTY IS EXCLUSIVE AND IN LIEU OF ALL OTHER WARRANTIES AND CONDITIONS, EXCEPT THE WARRANTY OF TITLE. BOBCAT COMPANY DISCLAIMS ALL OTHER WARRANTIES AND CONDITIONS, EXPRESS OR IMPLIED, INCLUDING ANY IMPLIED WARRANTIES OR CONDITIONS OF MERCHANTABILITY OR FITNESS FOR A PARTICULAR PURPOSE. IN NO EVENT SHALL BOBCAT COMPANY OR THE AUTHORIZED BOBCAT DEALER BE LIABLE FOR ANY SPECIAL, INCIDENTAL, INDIRECT OR CONSEQUENTIAL DAMAGES WHATSOEVER, INCLUDING, BUT NOT LIMITED TO, LOSS OR INTERRUPTION OF BUSINESS, LOST PROFITS, OR LOSS OF MACHINE USE, WHETHER BASED ON CONTRACT, WARRANTY, TORT, NEGLIGENCE, STRICT LIABILITY, STATUTE OR OTHERWISE, EVEN IF BOBCAT COMPANY OR THE AUTHORIZED BOBCAT DEALER HAS BEEN ADVISED OF THE POSSIBILITY OF SUCH DAMAGES. THE TOTAL LIABILITY OF BOBCAT COMPANY AND THE AUTHORIZED BOBCAT DEALERS WITH RESPECT TO THE PRODUCT AND SERVICES FURNISHED HEREUNDER SHALL NOT EXCEED THE PURCHASE PRICE OF THE PRODUCT UPON WHICH SUCH LIABILITY IS BASED.



WARRANTY (CONT'D)

In this emissions limited warranty, the term "Manufacturer" means Kubota Corporation as the holder of the U.S. Environmental Protection Agency (U.S. EPA) Certificate of Conformity and California Executive Order for the vehicle. The emission control limited warranty is in addition to the standard limited warranty for your vehicle.

Your Bobcat dealer is authorized to perform all warranty and service repairs on your diesel engine. To locate a Bobcat dealer, visit www.bobcat.com or call 1-800-743-4340.

KUBOTA Corporation

FEDERAL & CALIFORNIA EMISSION CONTROL SYSTEMS LIMITED WARRANTY for NON-ROAD ENGINES (CI)

The U.S. Environmental Protection Agency (EPA), the California Air Resources Board (CARB), and KUBOTA Corporation are pleased to explain the Federal and California Emission Control System Warranty on your non-road engine. In California, new heavy duty off-road engines must be designed, built and equipped to meet California's stringent anti-smog standards adopted by the Air Resources Board pursuant to its authority in Chapter 1 and 2, Part 5, Division 26 of the California Health and Safety Code. In other states of the U.S.A., new non-road engines subject to the provisions of 40 CFR 1039 subpart A must be designed, built and equipped, at the time of sale, to meet the U.S. EPA regulations for nonroad engines.

KUBOTA must warrant the emission control system on your Compression Ignition engine for the period of time listed below provided there has been no abuse, vandalism, neglect, improper maintenance or unapproved modifications to your engine. This emission warranty is applicable in all states of the U.S.A., its provinces and territories regardless of whether an individual state, province, or territory has enacted warranty provisions that differ from the Federal warranty provisions. This emission warranty is also applicable in all provinces and territories of CANADA.

Your emission control system may include parts such as the fuel injection system and the air induction system. Also included may be hoses, belts, connectors and other emission-related assemblies.

Where a warrantable condition exists, KUBOTA will repair your engine at no cost to you, including diagnosis (if the diagnostic work is performed at an authorized dealer), parts and labor.

EMISSION DESIGN AND DEFECT WARRANTY COVERAGE

The emissions warranty period for the engine begins on the original date of sale to the initial purchaser and continues for each subsequent purchaser for the period mentioned below.

The emissions warranty period for all engines rated under 19kW (25Hp) is 2000 hours of operation or two (2) years of use, whichever first occurs.

The emissions warranty period for constant speed engines rated under 37kW (50Hp) with rated speeds greater than or equal to 3000 rpm is 2000 hours of operation or two (2) years of use, whichever first occurs.

The emissions warranty period for all other engines not already listed is 3000 hours of operation or five (5) years of use, whichever first occurs.

If any emission related part on your engine is defective, the part will be repaired or replaced by KUBOTA free of charge.

OWNER'S WARRANTY RESPONSIBILITIES

(a) As the engine owner, you are responsible for the performance of the required maintenance listed in your KUBOTA operator's manual. KUBOTA recommends that you retain all receipts covering maintenance on your engine, but KUBOTA cannot deny a warranty claim solely for the lack of receipts or for your failure to ensure the performance of all scheduled maintenance.

(b) As the engine owner, you should be aware, however, that KUBOTA may deny your warranty coverage if your engine or a part has failed due to abuse, vandalism, neglect, improper maintenance or unapproved modifications.

(c) Your engine is designed to operate on Ultra Low Sulfur Diesel Fuel only. Use of any other fuel may result in your engine no longer operating in compliance with Federal or California's emissions requirements.

(d) You are responsible for presenting your engine to the nearest dealer or service station authorized by KUBOTA when a problem exists. The warranty repairs should be completed in a reasonable amount of time, not to exceed 30 days.

(e) If you have any questions regarding your warranty rights and responsibilities or the location of the nearest authorized dealer or distributor, you should contact: KUBOTA ENGINE AMERICA CORPORATION, Service department at 1-800-532-9808, EEWRI@kubotaengine.com or KUBOTA TRACTOR CORPORATION, National Service Department at 1-800-558-2682, KubotaEmissionsWarranty@kubota.com or KUBOTA CANADA LTD at (905) 294-7477.

COVERAGE

KUBOTA warrants to the initial purchaser and each subsequent purchaser that your engine will be designed, built and equipped, at the time of sale, to meet all applicable regulations. KUBOTA also warrants to the initial purchaser and each subsequent purchaser that your engine shall be free from defects in materials and workmanship which cause the engine to fail to conform to applicable regulations for the period mentioned above from the original date of sale.

KUBOTA shall remedy warranty defects at any authorized KUBOTA engine dealer or warranty station. Any authorized work done at an authorized dealer or warranty station shall be free of charge to the owner if such work determines that a warranted part is defective. Any KUBOTA approved or equivalent replacement part (including any KUBOTA approved aftermarket part) may be used for any warranty maintenance or repairs on emission related parts, and must be provided free of charge to the owner if the part is still under warranty.

KUBOTA is liable for damages to other engine components caused by the failure of a warranted part still under warranty. The use of replacement parts not equivalent to the original parts may impair the effectiveness of your engine emission control system. If such a replacement part is used in the repair or maintenance of your engine, and KUBOTA determines it is defective or causes a failure of a warranted part, your claim for repair of your engine may be denied.

Listed below are the parts covered by the Federal and California Emission Control Systems Warranty. Some parts listed below may require scheduled maintenance and are warranted up to the first scheduled replacement point for that part. The warranted parts are (if applicable):

- | | | |
|--|---------------------------------------|---|
| 1) Air-Induction System | 4) Electronic Control System | 6) Particulate Controls |
| a) Intake Manifold | a) ECU | a) Any device used to capture particulate emissions. |
| b) Turbocharger System | b) Engine Speed / Timing Sensor | b) Any device used in the regeneration of the particulate control device. |
| c) Charge Air Cooling System (Intercooler) | c) Accelerator Position Sensor | c) Control Device Enclosures and Manifolding |
| 2) Catalyst or Thermal Reactor System | d) Coolant Temperature Sensor | d) Diesel Particulate Filter Temperature Sensor |
| a) Catalytic converter | e) Atmospheric Pressure Sensor | e) Differential Pressure Sensor |
| b) Exhaust manifold | f) Intake Pressure Sensor | 7) Miscellaneous Items |
| 3) Fuel Injection System | g) Intake Manifold Temperature Sensor | a) Closed Breather System |
| a) Fuel Supply Pump | h) Intake Air Flow Sensor | b) Hoses*, Clamps*, Fittings, Tubing* |
| b) Injector | i) Common Rail Pressure Sensor | c) Gaskets, Seals |
| c) Injection Pipe | 5) Exhaust Gas Recirculation System | d) Kubota supplied engine Wiring Harnesses |
| d) Common Rail | a) EGR Valve | e) Kubota supplied engine Elec. Connectors |
| e) Smoke Puff Limiter | b) EGR Cooler | f) Air Cleaner Element*, Fuel Filter Element* |
| f) Speed Timer | c) EGR Valve Opening Rate Sensor | g) Emission Control Information Labels |
| g) Cold Advance Timer | | |
| h) Injection Pump | | |

*Warranty period is equivalent to manufacturer's recommended first replacement interval as stated in the applicable model's operator's manual and/or service (workshop) manual.

MAINTENANCE REQUIREMENTS

The owner is responsible for the performance of the required maintenance as defined by KUBOTA in the operator's manual.

LIMITATIONS

This Emission Control System Warranty shall not cover any of the following:

(a) Repair or replacement required because of misuse or neglect, improper maintenance, repairs improperly performed or replacements not conforming to KUBOTA specifications that adversely affect performance and/or durability, and alteration or modifications not recommended or approved in writing by KUBOTA.

(b) Replacement of parts and other services and adjustments necessary for required maintenance at and after the first scheduled replacement point.

ALPHABETICAL INDEX

(S70) LOADER SPECIFICATIONS	129	MAINTENANCE SAFETY	69
AIR CLEANER SERVICE	84	MONITORING THE DISPLAY PANELS	52
ALTERNATOR BELT	101	OPERATING PROCEDURE	58
ATTACHMENT CONTROL DEVICE (ACD)	42	OPERATOR CAB	80
ATTACHMENTS	54	OPERATOR SAFETY WARNINGS	1
BACK-UP ALARM SYSTEM	36	PARKING BRAKE	33
BACK-UP ALARM SYSTEM	78	PIVOT PINS	105
BOBCAT COMPANY IS ISO 9001 CERTIFIED	7	PRE-STARTING PROCEDURE	45
BOBCAT INTERLOCK CONTROL SYSTEM (BICS™)	113	PUBLICATIONS AND TRAINING RESOURCES	22
BOBCAT INTERLOCK CONTROL SYSTEM (BICS™)	32	REAR DOOR (TAILGATE)	83
BOBCAT INTERLOCK CONTROL SYSTEM (BICS™)	72	REGULAR MAINTENANCE ITEMS	7
BOB-TACH	106	SAFETY INSTRUCTIONS	15
CONTROL IDENTIFICATION	30	SEAT BAR RESTRAINT SYSTEM	31
DAILY INSPECTION	43	SEAT BAR RESTRAINT SYSTEM	74
DELIVERY REPORT	8	SEAT BELT	75
DRIVE BELT	102	SERIAL NUMBER LOCATIONS	8
DRIVING AND STEERING THE LOADER	38	SERVICE SCHEDULE	71
ELECTRICAL SYSTEM	91	SPARK ARRESTER MUFFLER	98
EMERGENCY EXIT	35	STARTING THE ENGINE	48
ENGINE COOLING SYSTEM	89	STOPPING THE ENGINE AND LEAVING THE LOADER	53
ENGINE LUBRICATION SYSTEM	88	STOPPING THE LOADER	38
ENGINE SPEED CONTROL	37	TIRE MAINTENANCE	99
FEATURES, ACCESSORIES AND ATTACHMENTS	10	TOWING THE LOADER	62
FINAL DRIVE TRANSMISSION (CHAINCASE)	100	TRACTION LOCK OVERRIDE	34
FIRE PREVENTION	17	TRANSPORTING THE LOADER ON A TRAILER	63
FUEL SYSTEM	85	TROUBLESHOOTING	111
HYDRAULIC CONTROLS	39	WARRANTY	135
HYDRAULIC / HYDROSTATIC SYSTEM	95		
INSTRUMENT PANEL IDENTIFICATION	27		
LIFT ARM BYPASS CONTROL	33		
LIFT ARM SUPPORT DEVICE	76		
LIFTING THE LOADER	63		
LOADER IDENTIFICATION	9		
LOADER STORAGE AND RETURN TO SERVICE	107		
LUBRICATING THE LOADER	103		
MACHINE SIGN TRANSLATIONS	117		
MACHINE SIGNS (DECALS)	20		



Bobcat®

0
1
2
3
4
5
6
7
8
9
10
11
12
13
14
15
16
17
18
19
20
21
22
23
24
25
26
27
28
29
30
31
32
33
34
35
36
37
38
39
40
41
42
43
44
45
46
47
48
49
50
51
52
53
54
55
56
57
58
59
60
61
62
63
64
65
66
67
68
69
70
71
72
73
74
75
76
77
78
79
80
81
82
83
84
85
86
87
88
89
90
91
92
93
94
95
96
97
98
99

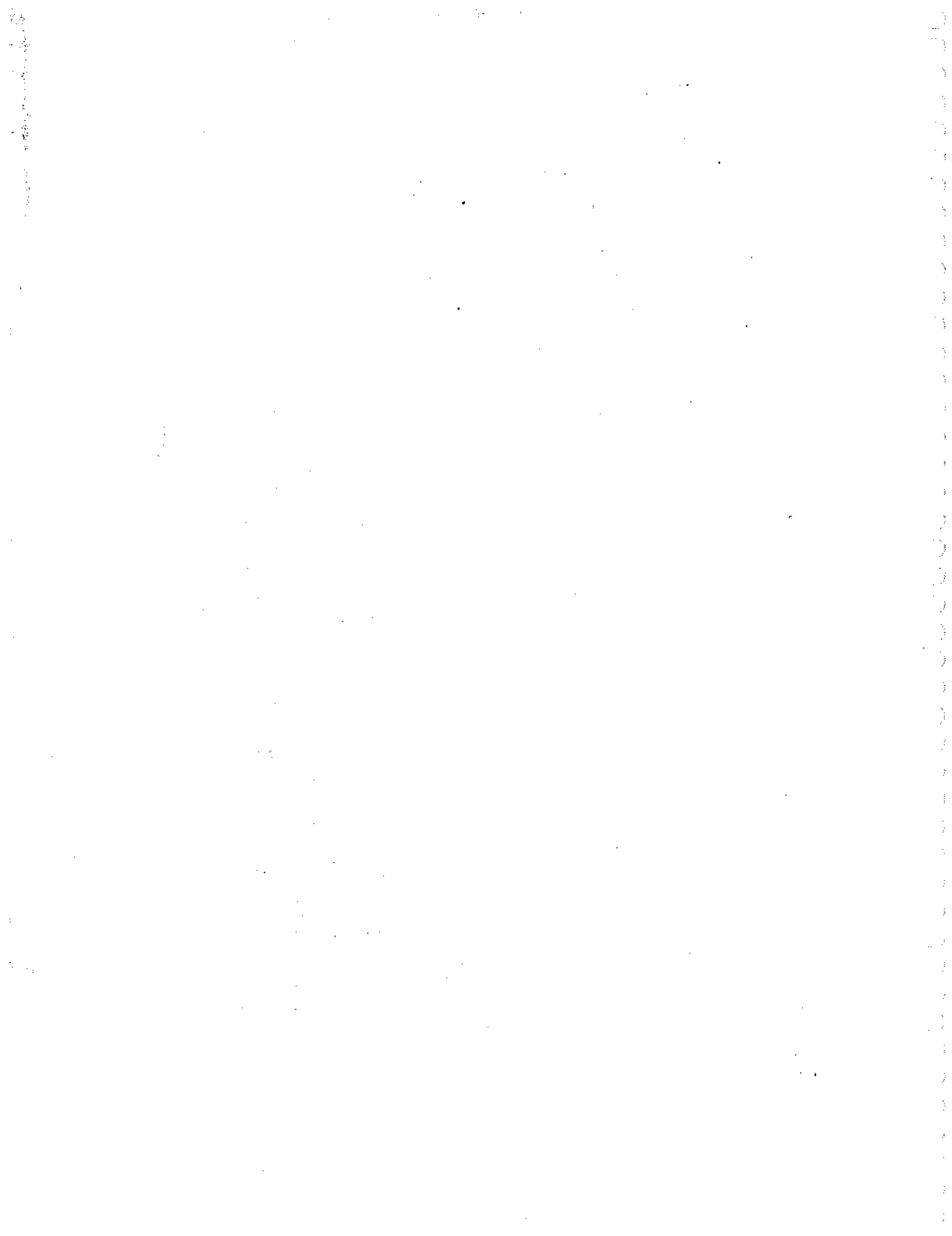

DAKEN



COMBINATION BUCKET



Operation, Maintenance & Parts Manual

Series 21 & 22

Version 11

DAKEN

Authorised Sellers Warranty

Daken Pty Limited (Daken) warrants the new products supplied by Daken to be free from defects in material and workmanship, under normal use and service, for a period of twelve (12) months from the date of delivery to the purchaser.

Daken, or its appointed dealer, will repair, replace or allow credit, at its sole option, any part(s) of the product, which under normal and proper use and maintenance proves to be defective in material or workmanship provided that:

- 1) The purchaser performs daily preventative maintenance as per Operation, Maintenance & Parts Manual.
- 2) Notice of any such defect and satisfactory proof is promptly given to Daken or its authorised dealer, and such part is returned for repair, with transportation charges prepaid.
- 3) Dakens examination proves such part(s) to have been defective.

This warranty coverage *does NOT APPLY*, and Daken shall have no obligation under this warranty in the following cases:

- 1) Damage or failures caused by accident, misuse, abuse, negligence, operation of a product in excess of recommended or design capacity, or natural calamity. This includes damage to the hydraulic hoses from the Attachment to the Loader caused by incorrect routing and/or pinching.
- 2) Damage or failures caused by use of other than Daken genuine or approved parts.
- 3) Damage or failures caused by the addition or removal from the attachment not approved or authorised by Daken.
- 4) Alterations, changes, or modifications made to the attachment or any of its components / parts not authorised by Daken (in writing), which, in the sole judgement of Daken, affects the performance, stability or purpose for which it was manufactured.
- 5) Damage or failures caused by lack of normal and/or preventative maintenance services as outlined in the Operation, Maintenance and Parts Manual.
- 6) Damage or failures caused by neglect or unreasonable delay by the purchaser in reporting to Daken or its appointed dealer, any defect or operating concern likely to be of a warrantable nature.
- 7) Normal wear and tear. This includes cylinders damaged by impacting material.
- 8) Loss of use of machine, loss of time, loss of revenue, damage to personal property, direct or indirect, incidental or consequential damages such as expenses for fuel, telephone, travel, lodging, transportation, or other costs resulting from warrantable failure.

Under the Trade Practices Act, 1974, as amended, certain conditions, warranties, rights and remedies may be implied if the buyer is a consumer within the meaning of that Act and under legislation relating to the sale of goods certain conditions and warranties may be implied if the sale of the product is a consumer sale within the meaning of such legislation; nothing contained herein excludes, restricts or modifies in relation hereto and the goods and/or services to be supplied hereunder any condition, warranty, right or remedy which applies hereto or to the supply of goods and/or services hereunder or is conferred upon the Buyer by or pursuant to the Trade Practices Act, 1974, as amended or the aforesaid legislation.

PROVIDED THAT to the extent of the Trade Practices Act, 1974, as amended permits Daken to limit its liability for a breach of a condition or warranty implied by that Act then Daken's liability for that breach shall be limited to:

- 1) in the case of goods supplied pursuant hereto, the payment of the cost of replacing the goods or of acquiring equivalent goods: and
- 2) in the case of services supplied pursuant hereto, the supplying of the service again.

INSPECTION AND PREPARATION

Your new Daken Attachment has been inspected and prepared in accordance with the Daken predelivery inspection schedule. The efficiency and economical operation of your new product now depends largely on the care it receives. Systematic attention to daily lubrication, inspections and adjustments by you or the Seller usually will result in greater satisfaction for you.

IMPROVEMENTS

Daken is constantly striving to improve its products. Changes in design and improvement will be made whenever Daken believes the efficiency of its products will be improved thereby, but without incurring any obligation to incorporate such improvements in an products which have been shipped or are in service.

If any provision in this Warranty is held invalid, unenforceable or illegal for any reason, this Warranty shall otherwise remain in full force apart from such provision which shall be deemed deleted from this Warranty.

CONTENTS

FORWARD

Reference Information	2
Serial Number Location	2
Attachment Delivery Report	2

SAFETY 3

OPERATING INSTRUCTIONS

Installing the Combination Bucket	6
Operating Procedure	8

MAINTENANCE

General	12
Daily Checks	12
Monthly Checks	12
Cylinder Removal	13

SPECIFICATIONS 14

TS MANUAL 15

FORWARD

Reference Information

Write the correct information for YOUR Combination Bucket in the spaces below.

Combination Bucket Number:..... Serial Number:.....

Dealer Contact:..... Dealer Contact Number:.....

Serial Number Location

The serial number is located on the attachment rating plate, which is affixed to the rear of the Combination Bucket.

Always use the serial number information of the attachment when requesting service information or when ordering parts. Earlier or later models (identification made by serial number) may use different parts, or it may be necessary to use a different procedure in doing a specific service operation.

Attachment Delivery Report

The Delivery Report must be filled out by the Dealer and signed by the owner or operator when the Combination Bucket is delivered. An explanation of the form must be given to the owner. Make sure it is filled out completely.

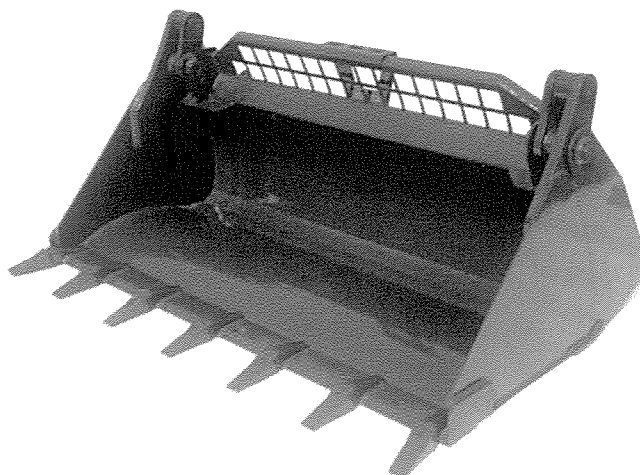

SAFETY

SAFETY IS THE OPERATOR'S RESPONSIBILITY !

The Daken Attachments are designed to give maximum safety; but no machine design can prevent operator error or carelessness.

READ THIS MANUAL BEFORE YOU OPERATE THE ATTACHMENT

 WARNING	Operator must have instructions before operating Loader and Attachment. Untrained operators can cause injury or death.
--	--



This Operation and Maintenance Manual was written to give the owner / operator instructions on the safe operation and maintenance of this Attachment.

 WARNING
Warnings on the machine and in the manuals are for your safety. Failure to obey warnings can cause injury or death.

IMPORTANT
This notice identifies procedures which must be followed to avoid damage to the machine.

Safe Operation Needs A Qualified Operator

A QUALIFIED OPERATOR MUST DO THE FOLLOWING:

1) UNDERSTAND THE WRITTEN INSTRUCTIONS, RULES & REGULATIONS

The written instructions include the Delivery Report, Loader Operator's Handbook, the Operation & Maintenance Manual, the Attachment Operation and Maintenance Manual, and machine signs.

Check the rules and regulations at your location. The rules may include and employer's work safety requirement. Regulations may identify a hazard such as an underground utility line.

2) *HAVE TRAINING WITH ACTUAL OPERATION*

Operator training must consist of a demonstration and verbal instruction.

The new operator must start work in an area without bystanders and use all the controls until they can control the Loader and Attachment safely under all conditions of the work area.

3) *KNOW THE WORK CONDITIONS*

The operator must know any prohibited uses or work areas for the equipment. For example, they need to know the location of underground lines.

For an operator to be qualified, they must not use drugs or alcoholic drinks which change their alertness or coordination while working. An operator who is taking prescription drugs must get medical advice to determine if they can safely operate a machine.

Be familiar with the weights of materials being worked.

4) *USE SAFETY RULES*

Check that the quick-attach levers are in the locked position and the wedges are fully engaged into the holes of the Attachment.

Make sure all the controls (levers and pedals) are in the NEUTRAL position before starting the Loader.

Keep your feet on the pedals (or floor plates), seat belt fastened snugly and seat bar lowered when operating the Loader and Attachment.

When learning to operate the Attachment, do it at a slow rate in an area clear of bystanders.

DO NOT permit personnel to be in the work area when operating the Loader and Attachment.

Before leaving the operator's seat, always lower the lift arms fully, engage the brake, stop the engine, raise the seat bar and move the pedals until both are locked (if a pedal machine).

DO NOT make any adjustments or repairs on the Loader or Attachment while the engine is running, or the hydraulic lines are pressurised.

Check for underground lines before digging.

Wear approved safety eye protection.

Do not modify equipment or add Attachments that are not approved by the manufacturer.

The Attachment must never be loaded more than a machines' Rated Operating Capacity.

Operate the Attachment only from the operator's seat.

Only operate the Attachment on the surface that it is standing on.

If load extends beyond the cutting edges, allowance should be made for a reduction in the Rated Operating Capacity.

In the event of hydraulic fluid spillage, clean up immediately and use caution to avoid slipping.

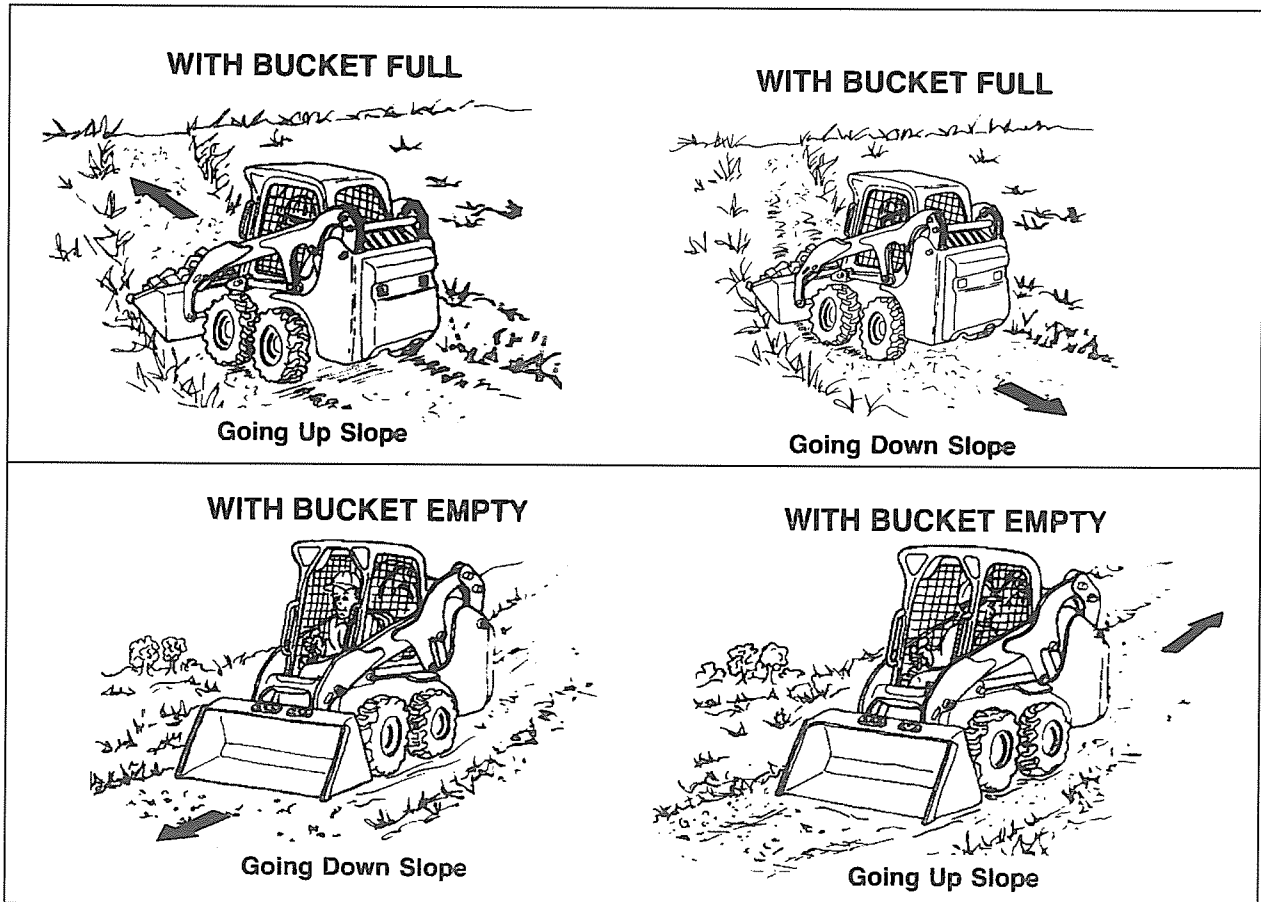

OPERATING INSTRUCTIONS

Installing The Combination Bucket

Connection / Removal

For Loaders equipped with the quick-attach type system:

- 1) Pull the quick-attach levers all the way up.
- 2) Tilt the quick-attach forward. Drive the Loader forward until the top edge of the quick-attach is completely under the flange of the Combination Bucket.
- 3) Tilt the quick-attach backward until the Combination Bucket is off the ground. Stop the engine.
- 4) Push down on the quick-attach levers until they are in the locked position.
- 5) Route the hydraulic hoses so they do not get caught

DO NOT hit the quick-attach levers on the Combination Bucket.

Quick Couplers

DO NOT allow dirt or debris to enter the hydraulic system. This will very quickly damage the hydraulic and hydrostatic components of the Loader.

Flush face couplers are used on all Daken Attachments. These significantly help to keep dirt and debris out of the hydraulic system.

Thus, remove any dirt, debris and hydraulic fluid from the surface of both the male and female coupler halves.

Visually check the couplers for corrosion, cracking, damage or excessive wear. If any of these conditions exist, the coupler(s) must be replaced. This is for both the machine as well as the Attachment. Caps and plugs are not used with flush face couplers.

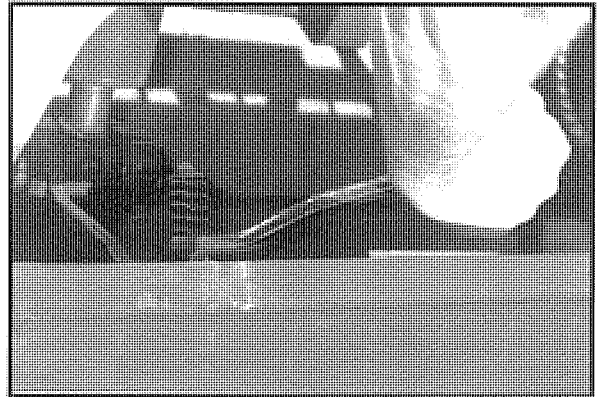

To Connect

Install the male half of the coupler into the female coupler. Full connection is made when the ball release sleeve slides forward on the female coupler and the sleeve is rotated.

Rotate the ball release sleeve so that the locking pins and the groove do NOT align (Locked Position). This will prevent accidental disconnection.

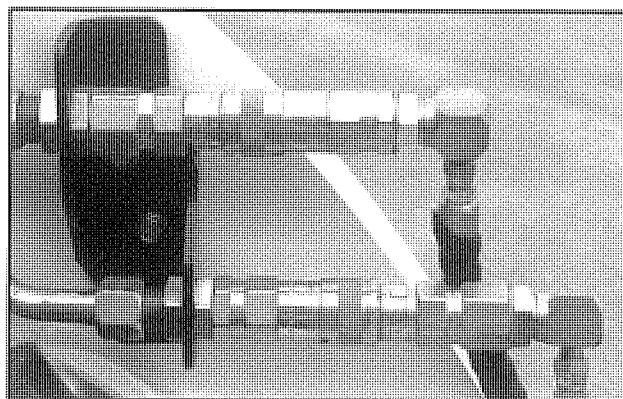

To Disconnect

Be aware that the coupler and fluid may be very hot and that skin can be pierced or broken by hydraulic oil under pressure.

Rotate the ball release sleeve so that the grooves are aligned with the pins in the female coupler.

Hold the male coupler. Retreat the sleeve on the female coupler until the couplers disconnect.

Getting On and Off

Use the steps, safety tread and grab handles to get on and off the loader.

Sit in the operator seat. Fasten the seat belt and lower the seat bar.

This is all covered in the Loader Operation and Maintenance Manual.

Interlock Control System

The Interlock Control System on Skid Steer Loaders generally require the operator to be seated in the operating position with the seat bar fully lowered before the lift, tilt and traction functions can be operated. The seat belt must be fastened anytime you operate the Loader.

Activate the auxiliary hydraulic functions as described in your Loader Operation and Maintenance Manual.

 **WARNING**

AVOID INJURY OR DEATH
Before you leave the operator's seat:

- Lower the lift arms, put the Attachment flat on the ground
- Stop the engine.
- Engage the parking brake.
- Raise seat bar, move pedals until both lock.

Quick-attach wedges must extend through the holes in Attachment. Levers must be fully down and locked. Failure to secure wedges can allow Attachment to come off and cause injury or death.

Operating Procedure

General

- Operating procedures described in this manual assumes foot pedal controls. For machines with Hand Controls, operators should refer to their Loader Operation and Maintenance Manual for the equivalent hand functions.
- The Combination Bucket can be used as a standard bucket for digging, loading and moving materials.
- Relieving pressure on from the quick couplers is described in your Loader Operation and Maintenance Manual.
- Always warm up the engine and the hydrostatic system before operating the Loader.
- Keep the travel distance short and the work area as level as possible.
- Always fill the bucket to the Rated Operating Capacity. The Loader will turn better with a full load (Rated Operating Capacity) than with just part of a load.
- Go up and down slopes with the heavy end of the Loader toward the top of the slope. Go directly up or down a slope, NEVER across the slope.
- Raise the Combination Bucket only high enough to avoid obstructions on rough ground.
- Keep bystanders at least three (3) metres away from the machine when operating any function.

Filling the Bucket

Push down on the top of the lift pedal until the lift arms are all the way down. Push the top of the tilt pedal to put the cutting edge of the Combination Bucket on the ground.

Drive slowly forward into the material. Push the heel of the tilt pedal to raise the front of the bucket. Drive backward away from the material.

Never fill the bucket in excess of the Rated Operating Capacity. The Combination Bucket has been designed for loading earth/wet sand. It is up to the operator to judge whether the material they are working with is heavier or lighter than earth/wet sand and/or the weight of the material being loaded.

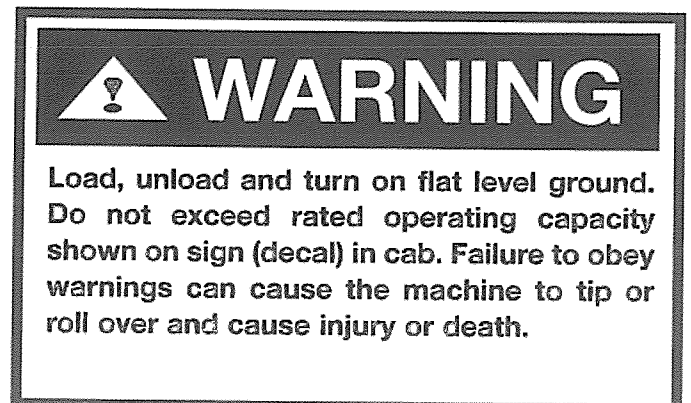

Emptying the Bucket

Push down on the heel of the lift pedal to raise the Combination Attachment over the truck box or bin.

Drive slowly forward until the Combination Bucket is over the top of the truck box or bin. Push the toe of the tilt pedal until the bucket is empty. If all the material is near the side of the truck box or bin, push it to the other side with the Combination Bucket.

When lifting the bucket to near full height, take care that loose material cannot fall over the spill guard into the operators cab.

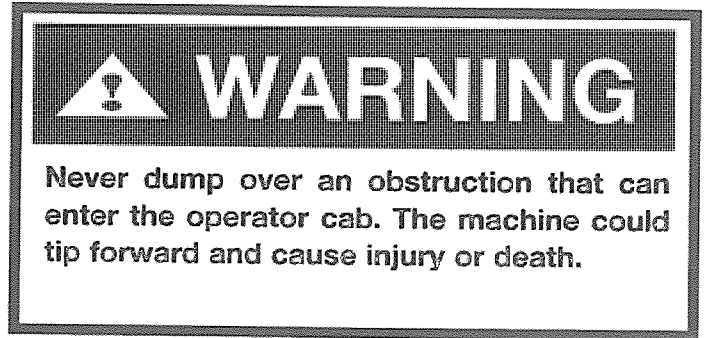

Digging Into the Ground

Put the lift arms all the way down. Push the toe of the tilt pedal until the cutting edge of the Combination Bucket is on the ground.

Drive forward slowly and continue to tilt the bucket down until it enters the ground.

Push the heel of the tilt pedal a small amount to increase traction and keep an even digging depth.

Continue to drive forward until the bucket is at the Rated Operating Capacity. When the ground is hard, raise and lower the cutting edge of the bucket with the tilt pedal while driving forward slowly.

Push the heel of the tilt pedal to tilt the bucket backward as far as it will go when the bucket is full.

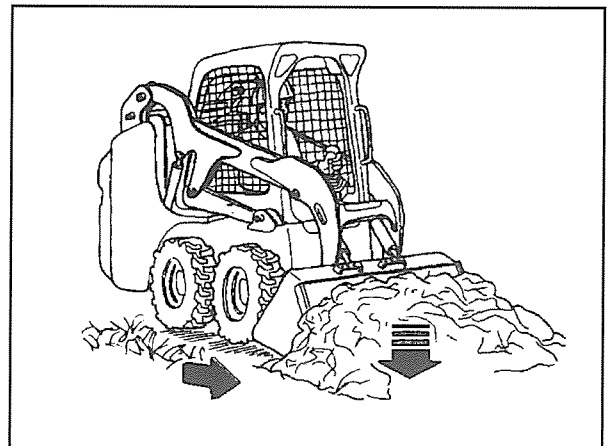

Leveling

Open the Combination Bucket nearly fully. Push the toe of the lift pedal all the way to lower the lift arms and to put the lift arms in float position. Tilt the quick-attach forward until the back side of the clamshell touches the ground.

Drive backward to level the ground.

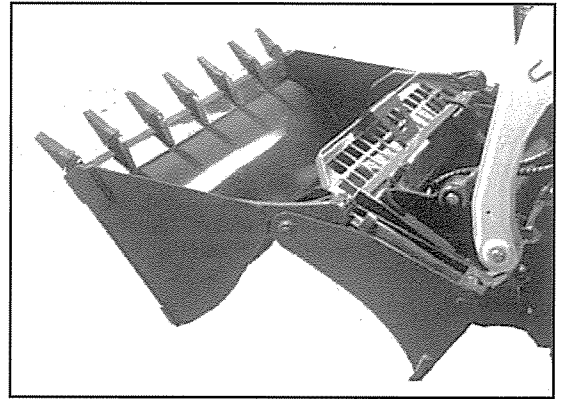

Dozing / Backfilling

Open the clamshell partially. Lower the lift arms. Tilt the quick-attach so that the blade is in a vertical position.

Drive forward to use as a dozer to push dirt etc or for grading and backfilling.

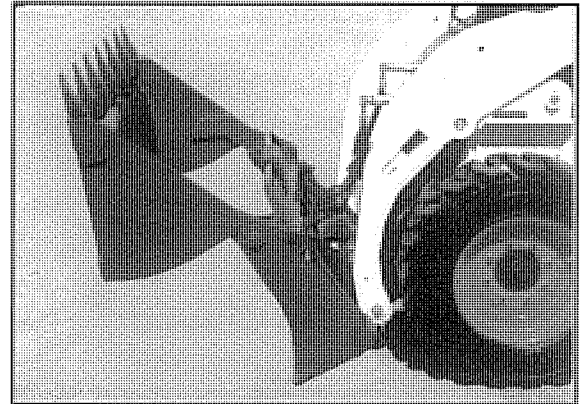

Grappling

Open the clamshell all the way and drive toward the object to be moved.

Push the dozer blade under the object and close the clamshell of the Combination Bucket.

Clamp objects at one corner of the Combination Bucket to provide more clamping force.



Parking the Loader

Stop the Loader on level ground. Close the bucket clamshell and place bucket flat on the ground before alighting.

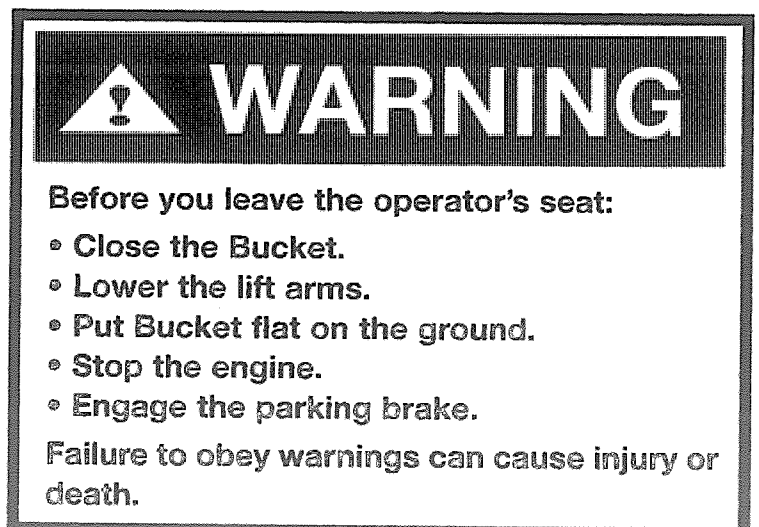

Transporting the Combination Bucket

Lifting the Combination Bucket

NOTE: Use lifting chains that are in good condition and of adequate size to lift the Combination Bucket. When new and empty, the bucket weighs 160 to 550 kg, depending on the model.

Hook the lifting chains to the bracing for the cylinders.

Fastening the Combination Bucket to the Transporting Vehicle

Put the Combination Bucket on the transport vehicle and hook chains to the bracing on both ends of the Combination Bucket. Secure the chains to the transport vehicle.

Rating of the Attachment

A loaders' Rated Operating Capacity (R.O.C.) is generally calculated with a standard or 'Rating' bucket. This Combination Bucket most likely exceeds the mass of the Rating Bucket used to rate your loader and may reduce your loaders Rated Operating Capacity.

To calculate your load; you need to know:

- 1) Combination Bucket mass & Heaped Capacity (on Rating Plate)
e.g. mass = 300kg, Heaped Capacity = 0.297m³
- 2) Rating Bucket mass (from your loader dealer) e.g. 210kg
- 3) Density of material you are working with. E.g. 1600kg/ m³ for earth/wet sand
- 4) Loader Rated Operating Capacity e.g. 590kg

Assuming the bucket is loaded to the Heaped Capacity:

Load = (mass Combination Bucket – mass Rating Bucket) + (Combination Bucket volume x Density of material).

E.g. Load = (300 – 210) + (0.297 x 1600) = 90 + 475.2 = 565.2 kg. This is less than the Rated Operating Capacity of 590kg, thus bucket is suitable for the loader.

ALWAYS ensure you DO NOT exceed the loaders Rated Operating Capacity.

MAINTENANCE

General

- *Daily Maintenance* on the Combination Bucket will ensure a long bucket life.
- *Hydraulic Couplers* – always ensure they are clean before attaching to the Loader or excavator. This will ensure that dirt and debris do not get into the hydraulic system via the couplers.
- *Cutting Edge* wear can become apparent after 250 hours (depending on the application). If wear is apparent, have the cutting edges hard faced.
- *Greasing* – MUST be done **DAILY** even more often if working in aggressive or dusty environments.
- *Pins* – Replacement is recommended every 1000 hours (assuming daily greasing).
- *Debris* – Dirt and debris can build up between the hydraulic cylinders and the back of the bucket. This should be cleaned out as needed.

Daily Checks:

- Grease all six (6) nipples.
- Clean debris from behind hydraulic cylinder.
- Check and rectify any damage on the Combination Bucket; including hosing.
- Check and rectify any oil leaks.

Monthly Checks:

- Inspect pins and bushes for wear (rectify as necessary)
- Inspect cylinder rods & seals for damage (rectify as necessary).

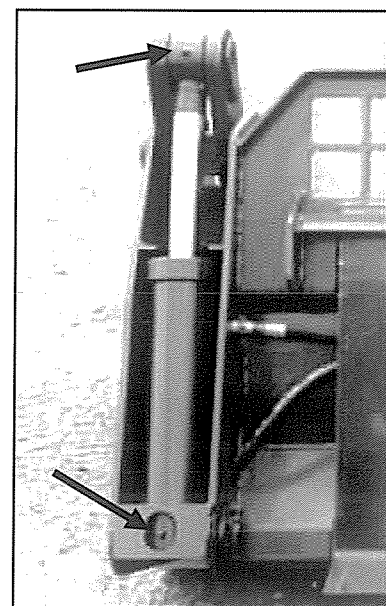

The cutting edges' excellent toughness and hardness are due to the alloying content. As such, the edges must be pre-heated to approximately 100°C before welding e.g. tooth shank replacement.

Cylinder Removal

- 1) Stop the engine. Relieve pressure at the front quick couplers.
- 2) Disconnect the Attachment quick couplers.
- 3) Remove the Combination Bucket from the quick-attach.
- 4) Remove the bolt and pin from the rod end (top) of the cylinder.
- 5) Mark the hydraulic hoses for correct re-installation.
- 6) Remove hydraulic hoses from the cylinder.
- 7) Remove the bolt and pin from the base end (bottom) of the cylinder.
- 8) Remove the hydraulic cylinder (See Attachment Service Manual or Loader Service Manual for repair procedures)
- 9) Installation is the reverse of the above procedure.

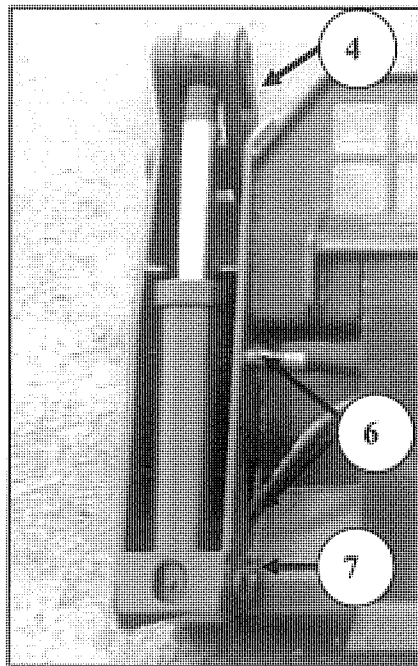

SPECIFICATIONS

Model #	Size	Size	Teeth	Capacity Heaped	# Teeth	Cutting Edge	Cutting Edge	Weight
	Inches	Millimetres		m ³		FRONT	REAR	kg
DC22110	44"	1120	No	0.15	0	16 x 80	12 x 80	160
DC22111	44"	1120	Yes	0.15	5	16 x 80	12 x 80	170
DC22120	48"	1220	No	0.18	0	16 x 80	12 x 80	170
DC22121	48"	1220	Yes	0.18	6	16 x 80	12 x 80	180
DC22130	54"	1370	No	0.19	0	16 x 80	12 x 80	175
DC22131	54"	1370	Yes	0.19	7	16 x 80	12 x 80	185
DC22140	55"	1400	No	0.25	0	16 x 150	16 x 80	265
DC22141	55"	1400	Yes	0.25	7	16 x 150	16 x 80	280
DC21160	61"	1550	No	0.28	0	16 x 110	16 x 80	300
DC21161	61"	1550	Yes	0.28	7	16 x 110	16 x 80	315
DC22160	61"	1550	No	0.29	0	16 x 150	16 x 80	300
DC22161	61"	1550	Yes	0.29	7	16 x 150	16 x 80	315
DC22180	68"	1730	No	0.31	0	16 x 150	16 x 80	315
DC22181	68"	1730	Yes	0.31	7	16 x 150	16 x 80	330
DC22190	74"	1880	No	0.34	0	16 x 150	16 x 80	330
DC22191	74"	1880	Yes	0.34	7	16 x 150	16 x 80	345
DC22210	80"	2030	No	0.45	0	20 x 180	16 x 100	465
DC22210 tooth kit	80"	2030	Yes	0.45	8	20 x 180	16 x 100	490
DC22210 bolt-on edge	80"	2030	No	0.45	0	20 x 180	16 x 100	500
DC22220	85"	2160	No	0.55	0	20 x 180	16 x 100	490
DC22220 tooth kit	85"	2160	Yes	0.55	9	20 x 180	16 x 100	520
DC22220 bolt-on edge	85"	2160	No	0.55	0	20 x 180	16 x 100	530

- Capacity refers to **Heaped Capacity**, and conforms to AS 2954.5 (1988) and ISO 7546 (1983)
- Density Rating used and recommended is 1600 kg/m³ (loose wet sand)
- Specifications subject to change without notice.
- Manufactured by a fully owned and operated Australian company.

PARTS MANUAL



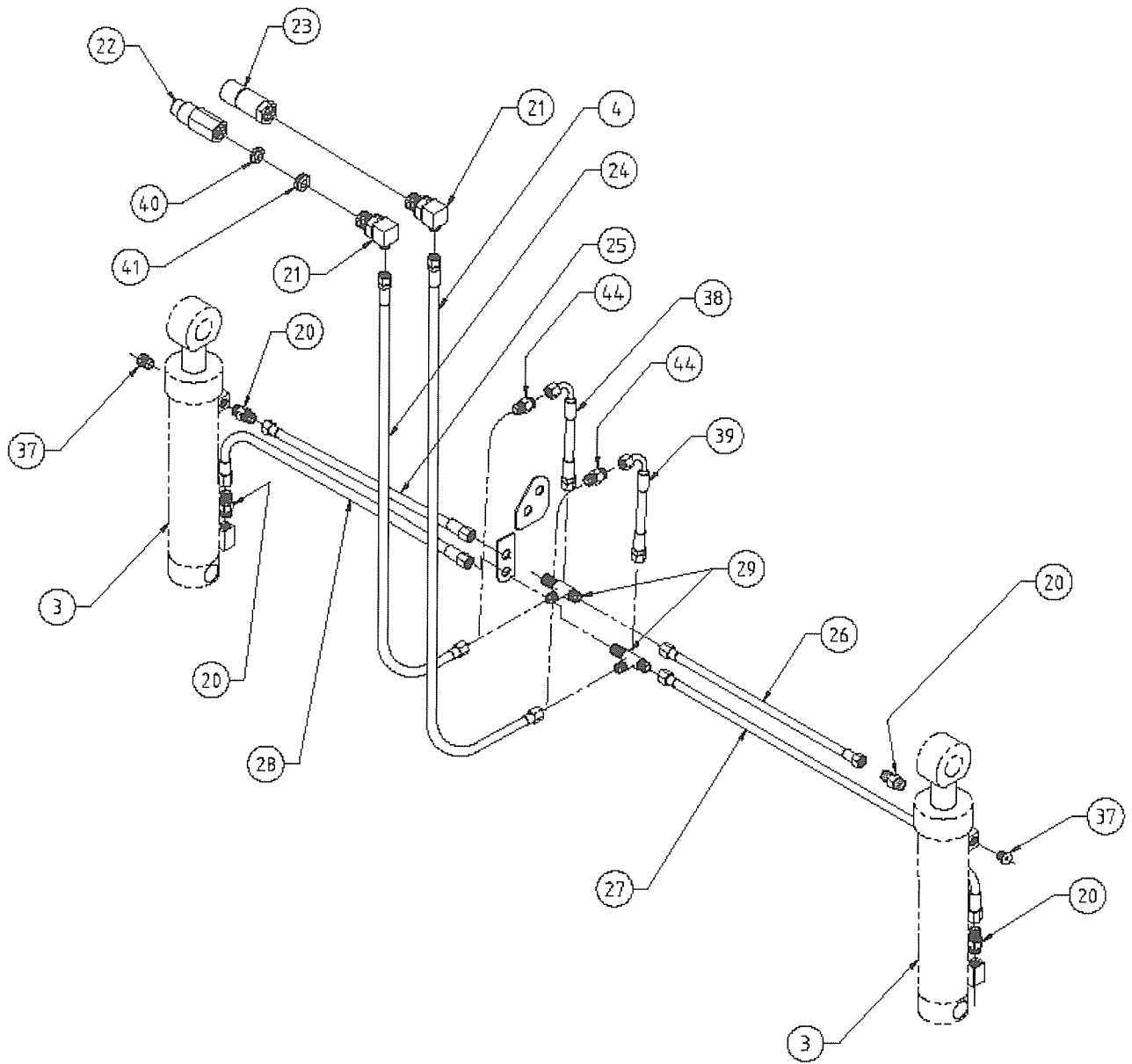

TYPICAL ILLUSTRATION NOT TO SCALE

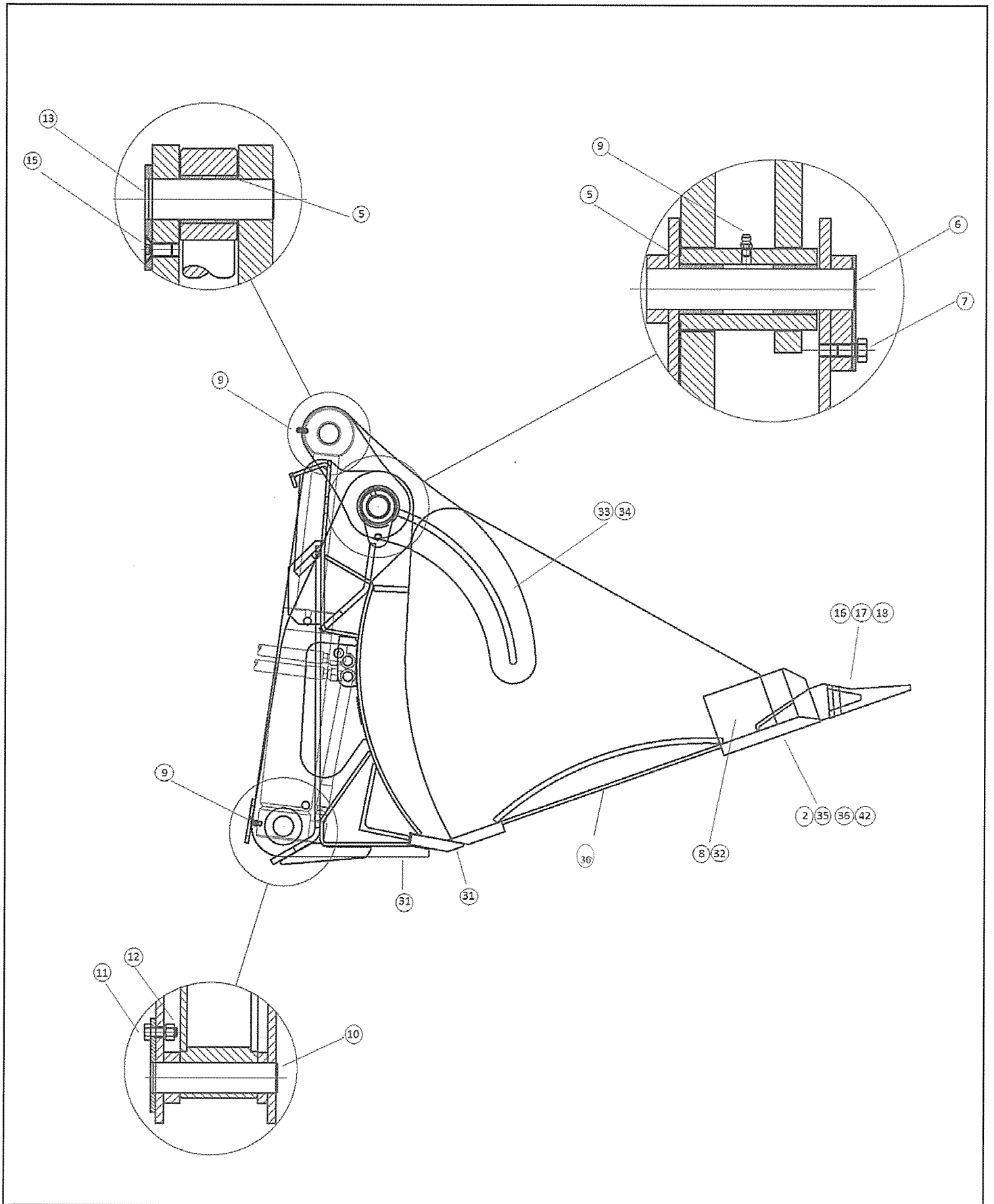

Part Listing

DC22111	DC22121	DC22131	DC22141	DC22161	DC22181	DC22191	DC22210	DC22220	Qty	Part name
45"	48"	54"	55"	61"	68"	74"	80"	85"		
1	3684918	3684918	3684918	3684918	3684918	3684918	TBA	TBA	1	Seal Kit
2	BL2296	BL2319	BL2180	BL2203	BL2137	BL2167	BL2391	BL2354	1	Edge cutting -Front
3	BL2402	BL2402	BL2330	BL2330	BL2330	BL2330	BL2348	BL2348	2	Cylinder Assembly
4	BL2269	BL2195	BL2195	3699400	3699400	3699400	3699400	3699400	1	Hose Assembly
5	BL2121	BL2121	BL2121	BL2121	BL2121	BL2121	BL2353	BL2353	8	Bushing - Inner Ring
6	BL2130	BL2130	BL2130	BL2130	BL2130	BL2130	BL2343	BL2343	2	Pin - Bellcrank Pivot
7	1CM1020	1CM1020	1CM1020	1CM1020	1CM1020	1CM1020	1CM1020	1CM1020	4	Bolt
8	BL2270	BL2270	BL2105	BL2105	BL2105	BL2105	BL2359	BL2359	1	Edge cutting - Right Hand Side
9	1HM8	1HM8	1HM8	1HM8	1HM8	1HM8	1HM8	1HM8	6	Grease Nipple - Straight
10	BL2132	BL2132	BL2132	BL2132	BL2132	BL2132	BL2341	BL2341	2	Pin - Cylinder Base
11	1CM1025	1CM01025	1CM01025	1CM01025	1CM01025	1CM01025	1CM01025	1CM01025	1	Bolt
12	4DM10	4DM10	4DM10	4DM10	4DM10	4DM10	-	-	2	Nut
13	BL2128	BL2128	BL2128	BL2128	BL2128	BL2128	BL2342	BL2342	2	Pin - Top Cylinder
15	23GM1020	23GM1020	23GM1020	23GM1020	23GM1020	23GM1020	23GM1020	23GM1020	2	Hex Socket Screw
16	BL2276	BL2122	BL2122	BL2122	BL2122	BL2122	6737322	6737322	7	Shank for Tooth
17	BL2278	3658935	3658935	3658935	3658935	3658935	6737326	6737326	7	Rollpin
18	BL2277	3658984	3658984	3658984	3658984	3658984	6737325	6737325	7	Tooth
19							BL2363	BL2363	7	Spacer plate (shank)
20	15K5	15K5	15K5	15K5	15K5	15K5	15K5	15K5	2	Fitting
21	6589193	6589193	6589193	6589193	6589193	6589193	6589193	6589193	2	Elbow
22	3680055	3680055	3680055	3680055	3680055	3680055	3680055	3680055	1	Coupler - Male
23	6672960	6672960	6672960	6672960	6672960	6672960	6672960	6672960	1	Coupler - Female
24	BL2264	BL2147	BL2147	3699401	3699401	3699401	3699401	3699401	1	Hose Assembly
25	BL2265	BL2265	BL2185	BL2143	BL2156	BL2196	BL2388	BL2350	1	Hose Assembly LH Cylinder TOP
26	BL2226	BL2175	BL2186	BL2144	BL2157	BL2173	BL2390	BL2352	1	Hose Assy RH Cylinder TOP
27	BL2267	BL2305	BL2187	BL2145	BL2158	BL2174	BL2389	BL2351	1	Hose Assy RH Cylinder Base
28	BL2268	BL2268	BL2188	BL2146	BL2159	BL2175	BL2387	BL2349	1	Hose Assy LH Cylinder BASE
29	91KV5	91KV5	91KV5	91KV5	91KV5	91KV5	91KV5	91KV5	2	Bulkhead Tee
30	BL2240	BL2294	BL2326	BL2212C	BL2209C	BL2222C	BL2385	BL2335	1	Floor assembly
31	BL2241	BL2295	BL2318	BL2099	BL2099	BL2168	BL2394	BL2357	1	Rear Cutting Edge
32	BL2271	BL2271							1	Edge cutting - Left Hand

Part Listing

	DC22111	DC22121	DC22131	DC22141	DC22161	DC22161	DC22181	DC22191	DC22210	DC22220	Qty	Part name
33	BL2248C	BL2249C	BL2091C	BL2091C	BL2091C	BL2091C	BL2091C	BL2091C	BL2338	BL2338	1	Bell crank Assy - Left Hand
34	BL2249C	BL2249C	BL2092C	BL2092C	BL2092C	BL2092C	BL2092C	BL2092C	BL2339	BL2339	1	Bell crank Assy - Right Hand
35	-	-	-	-	-	-	-	-	6718008	6807069	1	Bolt on front cutting edge
36	-	-	-	-	-	-	-	-	39C1032	39C1032	AVR	Bolt square csk
37	90K5	90K5	90K5	90K5	90K5	90K5	90K5	90K5	90K5	90K5	2	Plug
38	BL2263	BL2263	BL2263	-	-	-	-	-	-	-	1	Hose
39	BL2262	BL2262	BL2262	-	-	-	-	-	-	-	1	Hose
40	-	-	-	-	-	-	-	-	6668115	6668115	1	Orifice
41									BL2428	BL2428	1	Spacer Ring
42									85D10	85D10	AVR	5/8 Lock nut
43												
44		87F5									2	Fitting

Don't forget your Combination Bucket model and serial numbers if ordering parts!

NOTE: Model Number indicates with and without teeth i.e. DC21160 is WITHOUT teeth, DC21161 is WITH teeth
Excluding teeth, the buckets WITHOUT teeth, are otherwise the same bucket as those with teeth.

- DC22110 / DC22111 - 1120mm (45")
- DC22120 / DC22121 - 1220mm (48")
- DC22130 / DC22131 - 1370mm (54")
- DC22140 / DC22141 - 1400mm (55")
- DC21160 / DC21161 - 1550mm (61") Short Front
- DC22160 / DC22161 - 1550mm (61")
- DC21180 / DC21181 - 1730mm (68")
- DC21190 / DC21191 - 1880mm (74")
- DC22210 - 2030mm (80") - have optional bolt-on teeth
- DC22220 - 2160mm (85") - have optional bolt-on teeth

NOTES

SKID STEER LOADER

www.aem.org



SAFETY MANUAL

FOR OPERATING AND MAINTENANCE PERSONNEL



Table of Contents

Acknowledgment.....	2
Foreword	2
Safety Alerts.....	3
A Word to the User/Operator	3
Types of Skid Steer Loaders.....	4
One-Call First.....	4
Follow a Safety Program.....	5
Prepare for Safe Operation.....	7
Start Safely.....	10
Operate Safely	11
Shut Down Safely	16
Perform Maintenance Safely	17
Final Word to the User	22

Acknowledgment

We wish to thank the members of the Association of Equipment Manufacturers for their invaluable contributions in preparing this Safety Manual.

Many pictorials in this safety manual can be downloaded at <http://pictorials.aem.org>.

For additional publications, visit our website at www.safetymaterials.org.

Foreword

This safety manual is intended to point out some of the basic safety situations that may be encountered during the normal operation and maintenance of your machine and to instruct you in safety practices for dealing with these conditions. This manual is **NOT** a substitute for the manufacturer's operator's manual(s).

Additional precautions may be necessary, or some instructions may not apply, depending on equipment, attachments and conditions at the jobsite or in the service area. The manufacturer has no direct control over equipment application, operation, inspection or maintenance. Therefore, it is **YOUR** responsibility to use good safety practices in these areas.

The information provided in this manual supplements the specific information about your machine that is contained in the manufacturer's operator's manual(s). Other information that may affect the safe operation of your machine may be contained on safety signs or in insurance requirements, employer's safety and training programs, safety codes, local, state/provincial and federal laws, rules and regulations.



Read and understand
manuals before
operating

IMPORTANT! Before you operate this machine, make sure you have the manufacturer's manual(s) for this machine and all attachments. If the manufacturer's manuals are missing, obtain replacements from your employer, equipment dealer or directly from the manufacturer. Keep this safety manual and the manufacturer's manuals with the machine at all times. Read and understand all manuals.

Safety videos and other training resources are available from some manufacturers and dealers. Operators are encouraged to periodically review these resources.

NOTICE OF COPYRIGHT PROTECTION

Copyright 2013, by the Association of Equipment Manufacturers. All rights reserved. This work may not be reproduced or disseminated in whole or in part by any means without the prior written permission of the Association of Equipment Manufacturers.

Safety Alerts

Safety Alert Symbol

This Safety Alert Symbol means: **“ATTENTION! STAY ALERT! YOUR SAFETY IS INVOLVED!”**



The Safety Alert Symbol identifies important safety messages on equipment, safety signs, in manuals or elsewhere. When you see this symbol, be alert to the possibility of death or personal injury. Carefully read the message that follows and inform other operators. Follow instructions in the safety message.

Signal Words

Signal words are distinctive words that will typically be found on safety signs on the skid steer loader and other jobsite equipment. These words may also be found in this manual and the manufacturer’s manuals. These words are intended to alert the operator to a hazard and the degree of severity of the hazard.



DANGER indicates a hazardous situation that, if not avoided, will result in death or serious injury.



WARNING indicates a hazardous situation that, if not avoided, could result in death or serious injury.



CAUTION indicates a hazardous situation that, if not avoided, could result in minor or moderate injury.



NOTICE indicates a property damage message.

A Word to the User/Operator

It is **YOUR** responsibility to read and understand this safety manual and the manufacturer’s manuals before operating this equipment. This safety manual takes you step by step through the working day.

Graphics have been provided to help you understand the text.

Hazard recognition and accident prevention depend upon you being alert, careful and properly trained in the inspection, operation, transport, maintenance and storage of this equipment.

Remember that **YOU** are the key to safety. Good safety practices not only protect you but also protect the people around you. Study this manual and the manufacturer’s operating manuals for the specific machine. Make them a working part of your safety program. Keep in mind that this safety manual is written only for skid steer loaders with wheels and tracks.

After studying the manufacturer’s operating manual(s) and this safety manual, please contact the equipment manufacturer with any remaining questions.

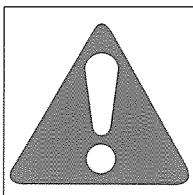

Read and understand all safety signs – replace damaged signs

Practice all usual and customary safe working precautions and remember:

SAFE OPERATION IS UP TO YOU!

YOU CAN PREVENT DEATH OR SERIOUS INJURY CAUSED BY UNSAFE WORK PRACTICES!

Types of Skid Steer Loaders

The skid steer loader is a self-propelled machine fitted with either wheels or tracks for use on different types of terrain. This highly maneuverable machine is often equipped with a bucket, pallet forks, or an approved attachment for specialized work. If your loader has a powered attachment, it is important to read the manufacturer's operating manuals pertaining to that attachment before operating.

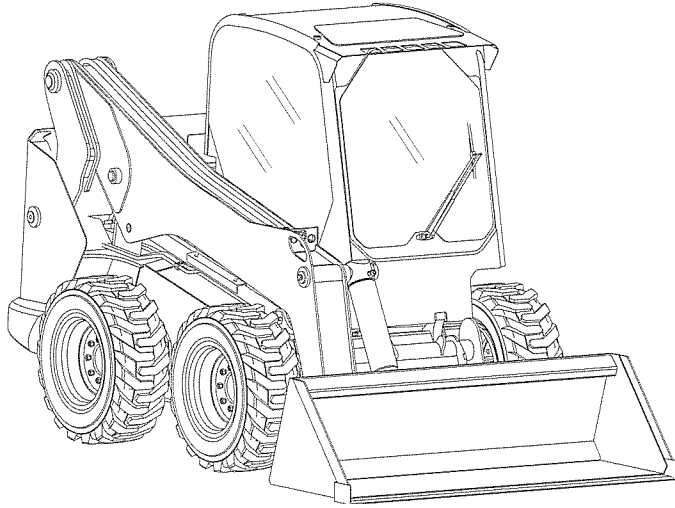

Wheeled

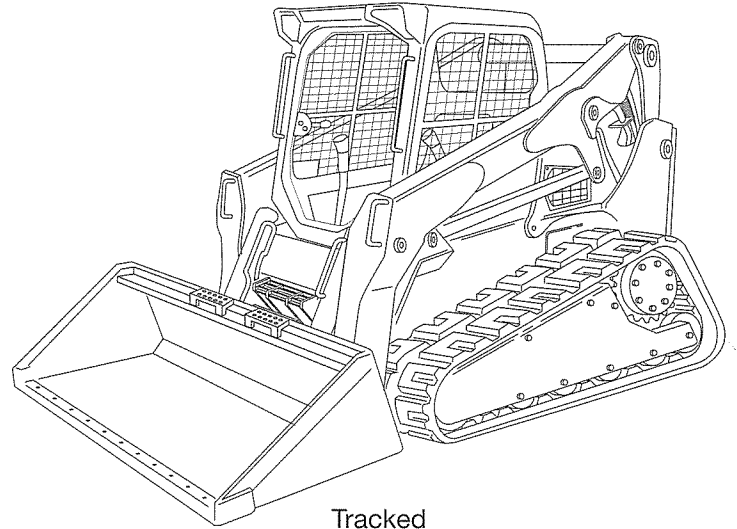

Tracked

When used normally, the skid steer loader excavates or loads through forward motion of the machine and lifts, transports and discharges material. To accommodate a wide range of conditions and personal preferences, some skid steer loaders have multiple control configurations, patterns and operating modes, each with unique operating characteristics.

One-Call First

Call

Before starting any digging project, contact the local One-Call service by dialing 811 (USA only) to have underground utilities located. A One-Call referral number, 1-888-258-0808, is also available for both USA and Canada.

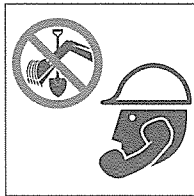
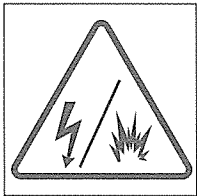

Call before you dig — dial 811 (USA only)
1-888-258-0808 (USA & Canada)

One-Call will notify participating utility companies that you intend to dig. You must also call any utility companies which do not participate in the One-Call service. Always inspect the jobsite for evidence of unmarked utilities and contact others if necessary.

Plan the Work

Be aware of the lead time for marking in the work area. This time may vary from state to state and county to county. If you do not locate utilities, you may have an accident or suffer injuries, cause service interruptions, damage the environment or experience job delays.

Dig

Most utilities mark their underground facilities using American Public Works Association (APWA) underground color codes. Verify marks before digging.

In the United States, The Occupational Safety and Health Administration (OSHA) Standard 29 CFR 1926.651 requires that the estimated location of underground utilities be determined before beginning an excavation. When actual excavation approaches an estimated utility location, the exact location of the underground installation must be determined by a safe, acceptable and dependable method. Other OSHA regulations may also apply to the jobsite.

APWA Underground Color Codes

Color	Description/Meaning
Red	Electric power lines, cables, conduit, lighting cables
Yellow	Gas, oil, steam, petroleum or gaseous materials
Orange	Communication, alarm or signal lines, cables or conduits
Blue	Potable water
Green	Sewers and drain lines
Purple	Reclaimed water, irrigation and slurry lines
White	Proposed excavation
Pink	Temporary survey markings

Follow a Safety Program

For Safe Operation

You must be a qualified and authorized operator for safe operation of this machine. You must clearly understand the written instructions supplied by the manufacturer, be trained — including actual operation — and know the safety rules and regulations for the jobsite. It is a good safety practice to point out and explain safety signs and practices to others, and to make sure they understand the importance of following these instructions.

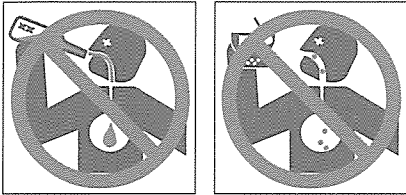

Never operate while impaired by alcohol or drugs

⚠ WARNING! Drugs and alcohol affect operator alertness and coordination, and the ability to safely operate the equipment. **Never operate the machine while impaired by use of alcohol or drugs. Never knowingly allow anyone to operate the machine when their alertness or coordination is impaired.**

An operator taking prescriptions or over-the-counter medication must consult a medical professional regarding any side effects of the medication that would hinder their ability to safely operate this equipment.

Be Alert!

Know where to get assistance. Keep emergency numbers for doctors, ambulance service, hospital and fire department near your telephone. Know how to use a first aid kit and fire extinguisher/fire suppression system; know their location and practice getting to them. Ensure they have been properly tested and maintained.

Let others know where you will be working, and what time you will be returning. In case of an emergency, you want others to know where to find you.

Be Aware!

Take advantage of training programs offered.

Know the proper response to a fire or chemical spill on your machine.

Be Careful!

Human error is the result of many factors: carelessness, fatigue, sensory overload, preoccupation, unfamiliarity with the machine or attachments, or drugs and alcohol, to name a few. You can avoid death or serious injury caused by these and other unsafe work practices. Be careful; never assume accidents cannot happen to you.

For your safety and the safety of others, act safely and encourage your fellow workers to act safely as well.

Protect Yourself

Wear all the personal protective clothing and Personal Protective Equipment (PPE) issued to you or called for by job conditions.

You may need:

- Hard hat.
- Safety shoes.
- Safety glasses, goggles or face shield.
- Heavy duty gloves.
- Hearing protection.
- Reflective clothing.
- Wet weather gear.
- Respirator or filter mask.

Wear whatever is needed to protect yourself — don't take chances.

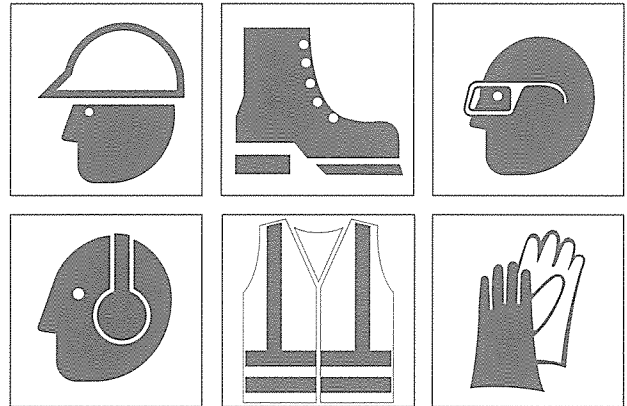

⚠ WARNING! Avoid death or serious injury from entanglement. **Do not wear loose clothing or accessories that could catch on moving parts or controls.** Examples of items to avoid include flopping cuffs, dangling neckties and scarves, wallets attached to chains, jewelry and wrist watches.

Know the Rules

Most job sites have rules governing equipment use and maintenance. Before you start work at a new location, check with the supervisor or safety coordinator. Ask about the rules you will be expected to obey.



Know and understand rules of operation

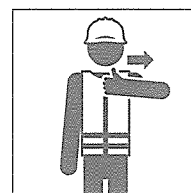

Understand jobsite signals

Follow a Safety Program

OSHA enforces federal laws within the United States that apply to the safe operation, application and maintenance of equipment on some jobsites. It is the employer's responsibility to comply with these laws. A federal representative may periodically inspect a jobsite to see that these laws are being followed.

There may be other local, state/provincial, federal laws or international organizations that regulate the use of this equipment, along with specific jobsite or employer rules. It is important that you know and comply with all applicable laws and rules, **including those requiring operator training and certification.**

These are some of the rules you must work by:

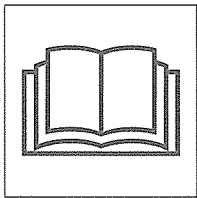

Read and understand manuals before operating

- Only qualified and authorized individuals may operate this equipment.
- Inspect your machine and attachments before each use as specified by the manufacturer and your employer.

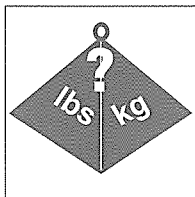

Know machine capacity and operating characteristics

- Know the capacity and operating characteristics of your equipment. Do not misuse it.
- Wear proper clothing and PPE. Check that others are also wearing appropriate clothing.
- All shields, guards, air filters, access panels and doors must be properly installed before each use.

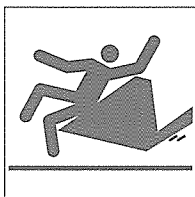

No riders

- Know the rules regarding traffic at your jobsite. Know what all signs, flags, and markings mean. Know hand, flag, horn, whistle, siren, or bell signals, if used.
- Never modify or remove any part of the machine (except for service; then make sure the part is re-installed or replaced if defective or worn out).

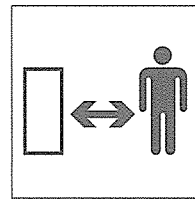

Keep bystanders away

- **Never allow children to play near, ride on or operate the equipment.**
- Keep bystanders well clear of the operation.
- Know the work area before you use the equipment. Be aware of possible hazards.
- Only use attachments and parts that are approved by the manufacturer.
- Do not allow riders.

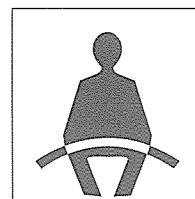

Fasten seat belt or operator restraint

- Fasten seat belt or operator restraint before starting.
- Drive forward whenever possible.
- Always look in the direction of travel.
- Look before backing up.
- Carry the load low.
- Never leave the operator's seat without lowering the bucket or other attachment flat on the ground, or engaging the approved lift arm support device(s) and then stopping the engine and removing the ignition key, if equipped. (See page 16, **Safe Shutdown.**)

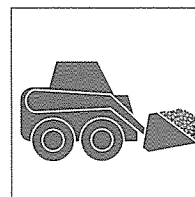

Carry the load low

- Use three-point contact (handholds and steps) and face the equipment when mounting or dismounting. (See page 10, **Mount and Dismount Properly.**)
- Never use the loader bucket as a man lift/transport or work platform.

Follow a Safety Program

Know the Equipment

Read and understand the DANGER, WARNING, CAUTION and NOTICE safety labels and other informational signs on the machine and the attachments, and in the manufacturer's operating manuals. Ask your supervisor or dealer to explain any information you do not understand. Failure to obey safety instructions could result in death or serious injury.

Know the following about your equipment:

- Function, purpose and use of all controls.
- Correct operation speeds.
- Slope and uneven terrain capabilities and proper operation.
- Braking and steering characteristics.
- Turning radius and clearances.

- How to quickly stop equipment in an emergency.
- Rated operating capacity.

Keep in mind that rain, snow, ice, loose gravel, soft ground, slopes, and other site conditions can affect your machine's operating capabilities. Make sure you are thoroughly familiar with your machine's stability, braking, traction, and other handling characteristics under any conditions you are likely to encounter.

IMPORTANT: This manual covers safe practices for skid steer loaders equipped with a bucket, pallet forks, or simple attachments. If your machine is equipped with specialized or powered attachments, such as a snow blower, backhoe, stump grinder or others, it is important to read the manufacturer's operating and safety manuals pertaining to that attachment before using it.

Prepare for Safe Operation

Check and Use All Available Safety Devices

To protect you and others around you, your machine may be equipped with the safety equipment listed below. Additional equipment may be required or some items may not apply, depending on attachments used, jobsite conditions or applicable jobsite rules. Check that each required item is securely in place and in operating condition:

- Falling Object Protective Structure (FOPS).
- Rollover Protective Structure (ROPS).
- Seat Belt.
- Operator seat/restraint bar(s)/interlock control system.
- Cab side-screens or windows.
- Special enclosures or accessories required for specific applications or jobsite conditions.
- Alternate exit (window).
- Grab handles.
- Lift-arm support device(s).
- Lights.
- Anti-skid tread/steps.
- Safety signs.
- Horn.
- Guards.
- Back-up alarm.
- Fire extinguisher.
- First aid kit.
- Rotating beacon.
- Windshield wiper/defroster.

Use them! Never remove or disconnect any safety device.

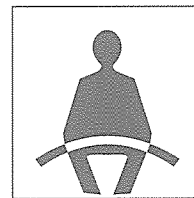

Fasten
your
seat belt

When using specialized attachments that may throw debris, such as a stump grinder or snow blower, make sure all cab openings are closed or covered with adequate protection, including impact-resistant glass, or polycarbonate (if required). Refer to the attachment's operating manual(s) for more specific information.

⚠ WARNING! Never remove or modify a ROPS or FOPS, except when servicing the machine. Serious injury or death could result.

Check the Machine

Before beginning your work day, inspect the machine and have all systems in good operational condition.

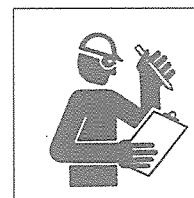

Inspect
the machine before
each work day

⚠ WARNING! Hydraulic system or part failure could cause unsupported equipment to fall. Avoid crushing injury from falling equipment. **Do not go under raised loader arm(s) unless it is properly supported according to the manufacturer's operating manual.**

Prepare for Safe Operation

- Perform daily and periodic service procedures as instructed by the equipment manufacturer.
- Check for broken, missing, loose, or damaged parts. Make necessary repairs.
- Check the tires or tracks for cuts, missing lugs, bulges, and correct pressure or track tension.
- Keep the steps and handholds clean and free of grease, oil, dirt, snow or ice.
- Check the parking brake for proper operation.
- Check condition and operation of attachment quick-coupling device. Perform daily cleaning and maintenance following manufacturer's instructions.
- Ensure shielding is properly installed and in good condition. Repair or replace if damaged or missing.
- Ensure work lights (if equipped) are kept clean. Check that all lights work properly.
- Ensure the horn and back-up alarm (if equipped) are operating correctly. Repair or replace if damaged.
- Ensure any Slow Moving Vehicle (SMV) signs, reflectors and warning lights are in good condition and can be clearly seen. Repair or replace if damaged.
- Ensure all tools or loose objects are removed or securely fastened while operating the machine.
- Check for damaged or leaky hydraulic systems. Repair or adjust as needed.

Hydraulic Fluid Injection Hazard

⚠ WARNING! Accidental injection of high-pressure oil into the hands or body is dangerous and could result in death or serious injury. **Use caution when checking hydraulic leaks as pressurized hydraulic fluid has enough force to penetrate skin, causing serious personal injury.**

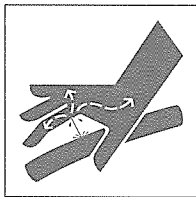

High pressure fluid can inject into the body

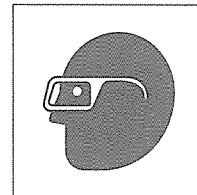

Wear eye protection

If a leak is discovered:

- Ensure engine is turned off; relieve pressure in hydraulic circuit.
- Wear proper hand and eye protection.
- Visually examine the hydraulic hose or fluid lines in the vicinity of the leak for breaks or cracks. **Do not** use your hand to check for leaks.
- Repair or replace hydraulic lines per manufacturer's recommendation.

Fluid injection injuries are not always obvious. Victims have reported such injuries feel like a bee sting or splinter under the skin. If you suspect you have a fluid injection injury, do not take chances. Seek proper

medical care immediately. If any fluid is injected into the skin, it must be surgically removed within a few hours by a doctor familiar with this type of injury.

Check the Cooling System

When checking the cooling system, make sure the engine is turned off and is cool. Remove the key to prevent fans from unexpectedly starting. Ensure the coolers and engine compartment are clean and free from debris, which could ignite and cause a fire.

If the machine is air-cooled, be sure the cooling unit has an unobstructed air flow. If it is liquid-cooled, check coolant level (at overflow tank, if provided).

⚠ WARNING! Allow the radiator to cool before checking the level. Hot radiator fluids could escape as steam and burn you. (See page 19, **Engine Coolant Hazards.**)

Clean Up

⚠ WARNING! Avoid serious injury or death. **Always lower the lift arm(s) or secure with the approved lift arm support device(s) and stop engine before cleaning any part of the machine.**

Clean windows, lights, and safety signs.

Make sure the operator's area, steering levers, pedals, joysticks, steps, and grab handles are clean. Oil, grease, snow, ice, mud, or debris in these areas could cause you to slip and fall, or lose control of the machine. Clean your boots of excess mud before entering the machine.

Remove all personal items or other objects from the operator's area. Secure these items in a toolbox or remove them from the machine.

Use Caution When Fueling

⚠ WARNING! Avoid injury from fire or explosion. **Never fill the fuel tank with the engine running, while smoking or when near an open flame.**

Never overfill the tank or spill fuel. If fuel is spilled, clean it up immediately.

Be sure to use the correct type and grade of fuel.

Ground the fuel funnel or nozzle against the filler neck to prevent sparks that could ignite fuel vapors. Be sure to replace the fuel fill cap (if equipped) when you are done.

Prepare for Safe Operation

Ultra-Low Sulfur Diesel (ULSD) Fuel Hazard

Avoid Static Electricity Risk When Fueling

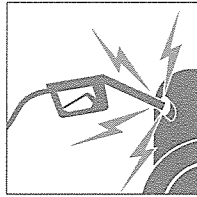

Static discharge during fueling can cause explosion

⚠ WARNING! Ultra-Low Sulfur Diesel (ULSD) poses a greater static ignition hazard than earlier diesel formulations. Avoid death or serious injury from fire or explosion; **consult with your fuel or fuel system supplier to ensure the delivery system is in compliance with fueling standards for proper grounding and bonding practices.**

Know the Working Area

Learn as much about your working area as possible.

Check at Ground or Floor Level

Inspect the surface over which you will travel. Look for holes, drop-offs and obstacles. Look for rough spots or hidden obstacles on surfaces which could cause a collision or loss of control. Look for weak spots on docks, ramps or floors. Look for oil spills, wet spots, and slippery surfaces. Look for soft soil, deep mud or standing water. Watch for anything that might make you lose control or cause the machine to roll over.

When operating inside a building, make certain you are within weight limitations of floors and ramps. Be aware of overhead clearances, doorways, aisles, etc. Plan travel routes ahead of time, in order to make sure you can see and protect bystanders. Pick up debris that can puncture tires or damage tracks.

Plan Your Work

Make sure you know where you will make your pickups, lifts, and turns. Before you raise a loader bucket, know where you will dump it, and **ALWAYS** carry the load low.

Check Overhead

Check the clearances of doorways, canopies, and overheads. Know exactly how much clearance you have under power and telephone cables. (See chart).

Required Clearance for Operation Near High-Voltage Power Lines

Normal Voltage kV (Phase to Phase)	Minimum Approach Distance [†]	
	ft.	(m)
Up to 50 kV	10	(3.0)
Over 50 to 200 kV	15	(4.6)
Over 200 to 350 kV	20	(6.1)
Over 350 to 500 kV	25	(7.6)
Over 500 to 750 kV	35	(10.7)
Over 750 to 1,000 kV	45	(13.7)
Over 1,000 kV	*	*

[†]Environmental conditions such as fog, smoke or precipitation may require increased clearances.

*As established by the utility owner/operator or registered professional engineer who is a qualified person with respect to electrical power transmission and distribution.

⚠ DANGER! Contact with energized power lines will cause serious injury or death. **Never approach overhead power lines with any part of your machine unless all local, state/provincial and national (OSHA) required safety precautions have been taken.** Always use extreme caution around power lines.

Know your margin of safety. If possible, have power

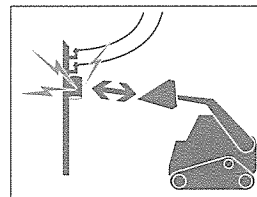

Stay away from energized power sources

to lines disconnected. If not possible, request a signal person for guidance.

⚠ DANGER! Electrocutation will result from touching or being near a machine that is in contact with, or near, an electrical source. **Stay away from any machine in contact with electrical wires until you are told it is safe to approach.**

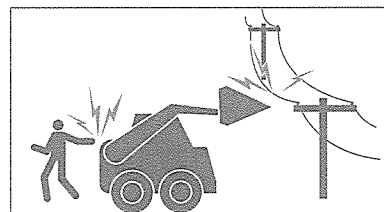

Avoid electrocutation, stay clear of energized power lines

Prepare for Safe Operation

Other Buried Hazards

CHECK UNDERGROUND. Know the location of gas lines and water pipes, or cables before digging.

⚠ WARNING! A cut fiber optic cable could cause serious eye injury if you look into the damaged end of the cable. **Do not look into damaged fiber optic cables!**

Always contact your local One-Call system and any utility companies that do not subscribe to One-Call before doing any digging. (See page 4, **One-Call First.**)

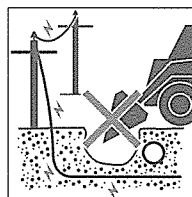

Locate all utilities, maintain a safe distance

Start Safely

Mount and Dismount Properly

⚠ WARNING! Avoid injury or death from being caught between the lift arm attachment and the machine. **Never mount or dismount a loader unless the lift arm(s) are lowered or secured by approved lift arm support device(s), and the engine is turned off.**

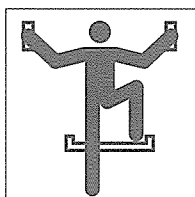

Use three points of contact when mounting or dismounting

Always use three-point contact when mounting or dismounting the machine. Three-point contact means one hand and two feet, or two hands and one foot, in contact with the machine at all times.

Never mount or dismount while carrying tools or objects that prevent three-point contact. Put parts or tools down. Maintaining proper contact, climb or dismount, and then pick up the object.

Face the machine when you enter or leave the machine.

Clean shoes and wipe hands. Clean steps and handholds of chemical residue, snow, ice, mud or oil.

During mounting and dismounting:

- Use handholds and step plates.
- Never use steering wheels, joysticks or controls as handholds.
- Never jump on or off the machine.
- Never mount or dismount from a moving machine.

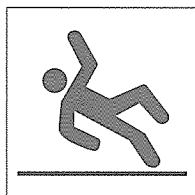

Avoid falls, clean up slippery areas

Warn Personnel Before Starting

Before starting, walk completely around the machine. **Make sure no one is under the machine, on it, or close to it.** Let others know you are starting up and don't start until everyone is completely clear of the machine. As the equipment operator, you are responsible for the safe use of the machine, so always make sure you have communicated your work plans to others on the site.

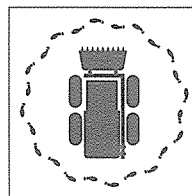

Before starting, walk completely around loader

Starting the Engine

⚠ WARNING! Start the engine from the operator's seat only. **Never attempt to start the engine by shorting across starter terminals.** The machine may move unexpectedly, which could cause serious injury or death to anyone in its path.

Know the exact starting procedure for your machine. See the manufacturer's operating manual(s) for starting.

- Sit in the operator's seat and adjust the seat so you can operate all the controls properly.
- Fasten the seat belt/operator restraint.
- Familiarize yourself with warning devices, gauges and operating controls.
- Lower the operator seat/restraint bar(s) (if equipped).
- Make sure controls are in the neutral/locked position.
- Clear the area of all persons.
- Start the engine following the instructions in the manufacturer's operating manual(s).
- If necessary to run the engine or operate the machine within an enclosed area, be sure there is adequate ventilation.

Start Safely

⚠ WARNING! Exhaust fumes can kill. **Do not breathe exhaust fumes!**

Starting Aids

If you have trouble starting the engine and need to use jumper cables, follow the instructions in manufacturer's operating manual(s). **Jump-starting is a two-person**

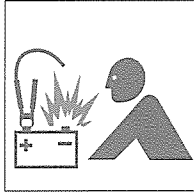

To avoid explosion, follow proper jump-starting procedures

operation. The operator must be in the operator's seat when jump-starting so the machine will be under control when the engine starts.

⚠ WARNING! A battery explosion or a run-away machine could result from improper jump-starting procedures. (See page 20, **Battery Hazards.**)

Ether/cold start fluid is **HIGHLY FLAMMABLE**. Before using it, always read the instructions on the ether/cold start fluid container and the instructions in the manufacturer's operating manual(s).

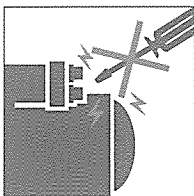

Never start engine by shorting across starter terminals

⚠ WARNING! Avoid injury from explosion or fire. If the engine is equipped with a glow plug pre-heater or other intake manifold type pre-heater, follow manufacturer's instructions before using ether/cold start fluid.

After Starting Engine

Observe gauges, instruments, and warning lights to assure that they are functioning and their readings are within the operating range.

Run an Operating Check

Do not use a machine that is not in proper operating condition. It is your responsibility to check the condition of all systems and to run the check in a safe area.

Test Controls

Loaders come equipped with various control configurations, patterns and operating modes, each with their own handling characteristics. Some have selectable or configurable controls, to suit personal preferences or specific applications. Make sure that you know which control pattern you have selected and that you understand how the machine will handle when using that control pattern.

Make sure the machine is operating properly by doing the following:

- With the control levers or joysticks in neutral, test engine speed control.
- Operate each pedal, lever or joystick to make sure all lift arm and tilt functions are correct.
- Operate the travel control lever(s) or joysticks to ensure correct operation in forward and reverse. Test steering to the right and to the left, while moving slowly in a clear, safe area.

⚠ WARNING! Before operating the machine under working conditions, **be certain you can control both the speed and direction of the machine.** Any loss of control could result in death or serious injury.

Operate Safely

Masked Visibility Areas

Machines have areas where the operator's visibility of the job site can be affected by the machine itself. ROPS posts, attachments, lift arms, even items in the cab, could limit your view of the surrounding area and possibly mask hazards or people around you. These masked visibility areas vary from machine to machine, and it is very important you be aware of these areas before operating your machine.

Follow these safety precautions to reduce the hazards posed by masked visibility areas:

- Pay particular attention when raising or lowering the bucket or other attachment, because masked visibility areas can change.
- Look around the machine before operating. Objects near the machine and close to the ground can be difficult to see from the cab.
- Always look in the direction of travel, including reverse. A back-up alarm is no substitute for looking behind you when operating the machine in reverse.
- Keep bystanders away, even if your machine is equipped with a back-up alarm.
- Keep the lift arm(s) low while traveling.

Operate Safely

Remember These Rules

Do not overload the bucket or attachment, or carry a load which could fall from the bucket or attachment. Keep loaded bucket level as lift arm(s) are moved and as loader moves up or down, on slopes and on ramps.

Different attachments can change the weight distribution of the loader. They can also affect its stability and handling response. Be sure you can keep the loader under complete control.

Install Attachments Properly

When changing buckets or installing attachments follow the manufacturer's instructions. Make sure all connectors are securely fastened. Tighten all bolts, nuts and screws to torque values recommended by the manufacturer.

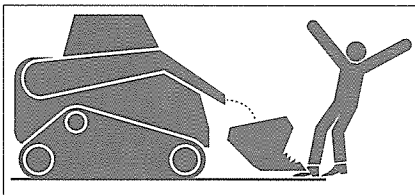

Avoid crushing injuries

⚠ WARNING! Failure to properly attach the machine coupler could result in serious crushing injury or death. **Properly secure the attachment to the machine coupler to prevent it from falling off.**

Check the attachment coupler and the attachment for wear and hydraulic leaks before coupling the attachment to the machine.

Check to be sure that the coupler pins or wedges are fully engaged into the attachment and that the coupler is securely engaged and locked to the attachment, both mechanically and hydraulically, before operating.

⚠ WARNING! Never modify your loader's ROPS. To do so could result in serious injury or death. (See page 7, **Check and Use All Available Safety Devices.**)

Know the pinch points and rotating parts on the loader; awareness on your part can prevent accidents.

Remember the Other Person

Never allow an untrained or unqualified person to operate the machine. If operated improperly, this machine can cause serious injury or death.

⚠ WARNING! The loader is a one-person machine. Avoid death or serious injury — **never permit riders! Never use the bucket, forks, or other attachments as a work platform or personnel carrier.**

⚠ WARNING! To avoid serious injury or death, never lift, swing, or move a load over anyone. **Keep others away from your operation.**

Back up Safely

Check that the back-up alarm, if equipped, is working properly. Remember, **a back-up alarm is not a substitute for looking to the rear when operating the machine in reverse.** Always look around before you back up the machine. Be sure that everyone is in the clear. Drive forward whenever possible. **ALWAYS LOOK IN THE DIRECTION OF TRAVEL.**

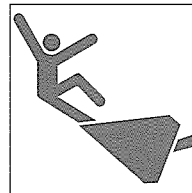

Never use the bucket as a work platform

Follow Safe Operating Practices

Make these safe practices part of your daily routine:

- Keep your seat belt/operator restraint fastened.
- Never leave the operator's seat without lowering the bucket or other attachment flat on the ground, or engaging the approved lift arm support device(s) and then stopping the engine and removing the ignition key, if equipped. (See page 16, **Safe Shutdown.**)
- Operate the controls smoothly — don't jerk the steering levers or joysticks.
- Carry the load low.
- Avoid sudden stops, starts or turns.
- Use care and good judgment.
- Never attempt to operate the controls unless properly seated in the cab.

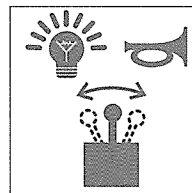

Operate instruments and controls smoothly

⚠ WARNING! Avoid Serious injury or death! **Keep your entire body inside the operator's cab while operating the machine.** Never work with your head, arms, feet or legs beyond the operator's compartment.

Use Attachments Safely

Most loaders can be operated with a wide variety of attachments. These include buckets, pallet forks, augers, snow plows and many others. Make sure the attachment is approved by the manufacturer for use on the machine you are operating. If you are not sure, ask your supervisor or contact your dealer. Be sure to read the manufacturer's operating manuals pertaining to that attachment before using it. Make sure the attachment is properly coupled to the machine before using it.

Operate Safely

Stay alert! Should something break, come loose, or fail to operate on your machine, stop work. Lower the lift arm(s), shut off the engine and inspect the machine.

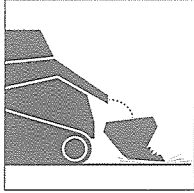

Make sure attachment is properly coupled.

Watch Out for Hazardous Working Conditions

Be alert for hazards. Know where you are at all times. Watch for branches, cables, or doorways.

⚠ WARNING! Avoid death or serious injury! **Never undercut a high bank.**

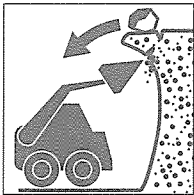

Never undercut a high bank.

Extreme caution should be used when working along the tops of banks or slopes. Always operate the loader perpendicular to the bank. Keep away from the edge.

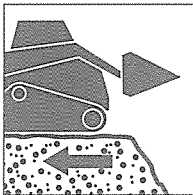

Operate perpendicular to banks – stay back from the edge.

⚠ WARNING! Never operate the machine close to the edge of an overhang or gully. The edges could collapse or a slide could occur causing serious injury or death.

Use caution when working along docks, runways, banks and slopes. Keep away from the edges of drop-offs.

Stay alert! Cave-ins can be hazardous!

Use caution when working beneath an overhang.

Use caution when backfilling. Do not get too close to the trench wall. The combined weight of the equipment and the load could cause the trench wall to give way.

When working near hazardous conditions, have a spotter work with you to look for dangers. Make certain they stay a safe distance from your machine.

Be careful when handling materials such as rocks, gas cylinders, barrels, etc. Lifting too high and rolling the bucket too far back could result in these materials falling into the operator's compartment. Special enclosures to restrict material from entering cab openings (with a polycarbonate door, for example) may be available for use with certain attachments. Check with your dealer.

Traveling on Jobsite

Take it slow and easy when traveling through congested areas. Traffic courtesy pays off.

Give the right-of-way to loaded machines. Maintain a safe distance from other machines. Pass cautiously.

Don't obstruct your vision when traveling or working. (See page 11, **Masked Visibility Areas.**) Carry the bucket **LOW** for maximum stability and visibility while traveling. Operate at speeds slow enough so you have complete control at all times. If possible, avoid travel over rough, slippery or uneven terrain, and on hillsides.

Travel Safely

Always have the lift arm(s) down when traveling or turning. Plan the operation to load, unload and turn on flat, level ground.

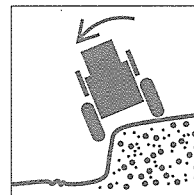

Use caution – stay safely away from bank or excavation edge.

Never ram the bucket into a material pile. Skid steer loaders have more force at slow speeds.

When traveling over rough terrain, **SLOW DOWN** to prevent losing control.

Both tracked and wheeled loaders can drop down suddenly if you are traveling over uneven surfaces like curbs, ramps or similar types of surfaces. If you cannot avoid these types of operating conditions, drive slowly when you approach these types of uneven surfaces to avoid spilling your load or tipping the machine. **ALWAYS CARRY THE LOAD LOW.**

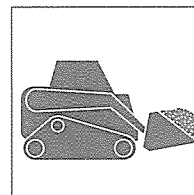

Keep loads low when traveling.

Operate Safely

Raise loads slowly and at an even rate, and be ready to lower the load quickly if the machine becomes unstable.

Avoid steep slopes or unstable surfaces. If you must drive on a slope, keep the load low and proceed with extreme caution. Do not drive across an excessively steep slope under any circumstances. Travel straight up and down the slope. Before operating on slopes, check the surface conditions for adequate traction. Loss of traction can cause the machine to slide and tip.

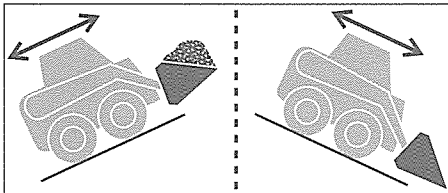

Keep heavy end of loader uphill

⚠ WARNING! Avoid death or serious injury. **Travel up and down slopes with the heavy end of the machine pointed uphill.**

Loaders are heavier on the rear end when unloaded and heavier on the front end when fully loaded, so remember this simple rule:

- **Loaded** bucket: Machine pointed uphill.
- **Empty** bucket: Machine pointed downhill.

Check machine manufacturer's recommendations.

A skid steer loader's center of gravity will shift as loads are raised and lowered, so do not assume it will handle the same way when the load's elevation or position has changed. Avoid changing direction of travel, making sharp turns or traveling on steep slopes with a raised load. If you are working on a ramp or slope, locate a flat, level area so you can turn, load and unload safely.

⚠ WARNING! Avoid death or serious injury. **Keep the load as low as possible** for maximum stability AND VISIBILITY.

⚠ WARNING! Avoid death or serious injury. **Make sure you can see where you are going.** Never travel with a load obstructing your vision.

⚠ WARNING! **Never unload material over an obstruction**, such as a post, that could enter the operator cab. This could cause the machine to tip forward or flip, causing serious injury or death.

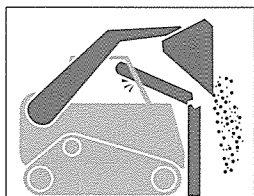

Never unload over objects that can enter cab

Rules of the Road

When traveling on public roads or streets, obey all traffic regulations applicable to loader use and classification.

Make sure lights and warning signs are in place and visible. Make sure a Slow Moving Vehicle (SMV) emblem is installed and visible to any vehicle approaching from the rear.

Find out if you must use an escort vehicle. Place the bucket in the transport position. Approach intersections with caution; observe speed and traffic control signs. Avoid panic stops and sharp turns.

Like any responsible operator, be considerate of other drivers. If traffic backs up behind you, it is a good idea to pull over periodically and allow traffic to pass when it is safe to do so.

Stop at all railroad crossings and look both ways before proceeding. Never park in traffic areas. If it is necessary to stop at night, pull off the road and set up flares or reflectors. When driving at night, use appropriate lights.

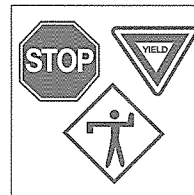

Obey traffic regulations

Watch Out for Obstacles

Adjust your speed to conditions. Go around rocks and stumps. Avoid crossing ditches, curbs or exposed railroad tracks. If obstacles are unavoidable, reduce speed, raise bucket or attachment a short distance (if needed for clearance) and cross at an angle. If the loader bucket is being used to scrape pavement, check for hidden obstacles that could cause a collision.

Keep your skid steer loader under control. Keep speed to a minimum when visibility is poor.

Before entering underpasses, tunnels or bunkers, check for oncoming traffic or obstructions.

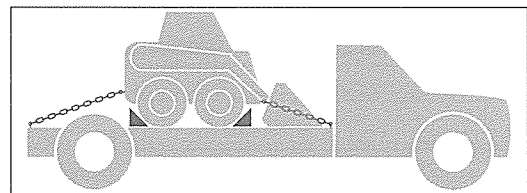

Chain and block loader securely for transport

Operate Safely

Loader Transporting Safety Tips

Always wear your seat belt/operator restraint when loading or unloading your machine from a transport device, such as a flatbed truck.

When transporting a loader, follow the manufacturer's recommended loading and unloading procedures.

Several precautions are applicable to all machines:

- Keep bystanders away.
- Load and unload on a level surface.
- Maintain proper visibility by loading or unloading in well-lit areas, and away from other vehicles, equipment or buildings.
- Block transport vehicle so it cannot move.
- Ensure trailer bed and ramps are in good condition.
- Use ramps of adequate size and strength, with a low angle and proper height.
- Rear of trailer must be blocked or supported.
- Keep trailer bed and ramps free of clay, oil, ice, snow, and other materials which can become slippery.
- Back the machine up the ramp onto the transport vehicle. If the machine is equipped with a heavy attachment it may be necessary to drive forward onto the transport vehicle.
- Cover or remove rear-facing SMV sign on the skid steer loader, if equipped, to avoid confusing drivers following the transport vehicle.
- Chain and block the machine securely for transport. Use tie-down points as marked on the machine by the manufacturer. Follow the manufacturer's instructions in the operator's manual for tying down.
- Unload the machine by driving off in the opposite direction; do not turn the machine around.

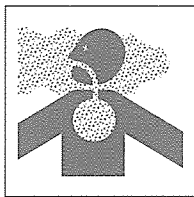

Ventilate work area

Exhaust Fumes in a Closed Space Can Kill

Vent exhaust and assure a flow of fresh air when an internal combustion engine is used in a closed space.

WARNING! Exhaust fumes from diesel, gasoline or LP gas engines can kill. **Do not breath exhaust fumes from any kind of engine.**

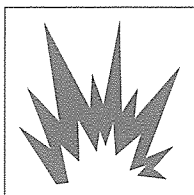

Do not operate in explosive/flammable atmosphere

Operating in Flammable/Explosive Atmospheres

WARNING! A standard loader or loader equipped with a spark arrestor/spark arresting muffler cannot be operated in flammable or explosive atmospheres. Using them in explosive atmospheres can result in fires and/or explosions which could cause serious injury or death.

Use only an approved skid steer loader with a label designation of **G, GS, D, DS, DY, LP, LPS, G/LP, or GS/LPS**. See Code of Federal Regulations (OSHA) 29 CFR Part 1910.178 to determine permissible areas where these machines can be operated.

Electrical Hazards Overhead and Underground

DANGER! Contact with energized power lines will cause serious injury or death. **Never approach overhead power lines with any part of your machine unless all local, state/provincial and national (OSHA) required safety precautions have been taken.** Always use extreme caution around power lines.

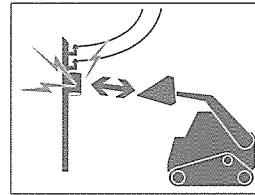

Stay away from energized power sources

Know your margin of safety. (See chart on page 9.) If possible, have power to lines disconnected. If not possible, request a signal person for guidance.

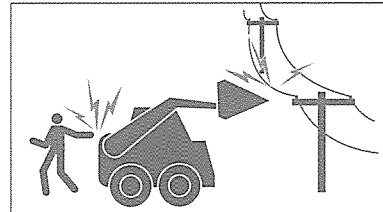

Avoid electrocution, stay clear of energized power lines

DANGER! Electrocution will result from touching or being near a machine that is in contact with, or near, an energized electrical source. **Stay away from any machine in contact with electrical wires until you are told it is safe to approach.**

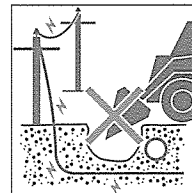

Locate all utilities, maintain a safe distance

Operate Safely

Other Buried Hazards

CHECK UNDERGROUND. Know the locations of gas lines, water pipes, and cables before digging.

Always contact your local One-Call system and any utility companies which do not subscribe to One-Call before doing any digging. (See page 4, **One-Call First.**)

⚠ WARNING! Fiber optic cables are often made of glass which can be very sharp when broken. They frequently carry infrared or laser light, which may not be visible, but is still very dangerous. To avoid serious injury, **do not handle or look directly into the exposed ends of damaged fiber optic cables!**

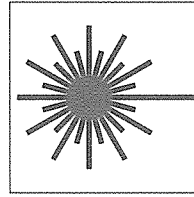

Do not
look into
fiber optic
cables

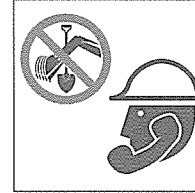
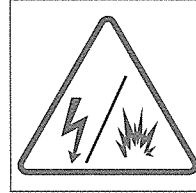

Call before you
dig—dial 811
(USA only)
1-888-258-0808
(USA & Canada)

Shut Down Safely

Select a Proper Parking Site

When shutting down, select level ground whenever possible. If you must park on a slope or incline, position the loader at right angles to the slope, engage the parking brake, lower the bucket (and other attachments) to the ground and block the wheels or tracks.

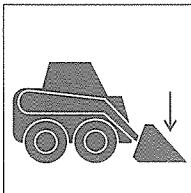

Lower
attachment

If arm(s) need to be in the raised position for maintenance, remove attachments as specified in the manufacturer's operating manual and secure the arm(s) using the approved lift arm support device(s).

⚠ WARNING! Avoid death or serious injury. **Never leave the loader unattended with the engine running or the lift arm(s) raised.**

Safe Shutdown

The detailed shutdown procedure is given in your manufacturer's manual(s). In general, this includes:

- Stop loader.
- Lower bucket or other attachment flat on the ground.
- Ensure all wheels or front of tracks are on the ground.
- Position controls in neutral or locked position.
- Engage parking brake.
- Idle engine for short cool-down period.
- Stop engine and remove ignition key (if equipped.)
- Cycle hydraulic controls to eliminate pressure.
- Raise operator seat/restraint bar(s) (if equipped).
- Make sure controls are locked in neutral (if equipped).
- Unbuckle seat belt/restraint.
- Lock covers and enclosures.
- Shut off master electric switch (if equipped).
- When you leave the loader, always maintain three-point contact with the steps and grab handles. Face the loader as you dismount. Never jump off machine.
- Block wheels or tracks if on a slope or incline.

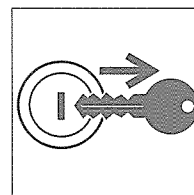

Shut engine off,
remove key

Perform Maintenance Safely

Know What You're Doing

Maintenance on this type of machine is not for inexperienced or untrained personnel. It can be hazardous unless performed properly. Be sure you have the necessary skill, information, correct tools and proper equipment to do the job safely.

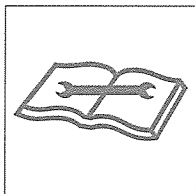

Maintain equipment

Be sure to maintain the equipment according to the manufacturer's instructions. Regularly check the operation of the protective and safety devices.

Do not perform any work on a machine unless you are authorized and qualified to do so.

If you have been authorized to perform maintenance, **read the manufacturer's operating and service manuals.** Study the instructions: check the lubrication charts, examine all the instruction messages on the machine.

Protect Yourself

Wear all the personal protective clothing and PPE issued to you or called for by job conditions.

You may need:

- Hard hat.
- Safety shoes.
- Safety glasses, goggles or face shield.
- Heavy duty gloves.
- Hearing protection.
- Reflective clothing.
- Wet weather gear.
- Respirator or filter mask.

Wear whatever is needed to protect yourself. Do not take chances.

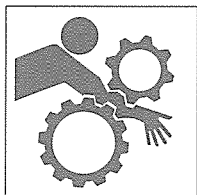

Avoid rotating parts

⚠ WARNING! Avoid death or serious injury from entanglement. **Do not wear loose clothing or accessories. Stay away from all rotating components when the engine is running.** Contact, wrapping or entanglement with rotating or moving parts could result in death or serious injury.

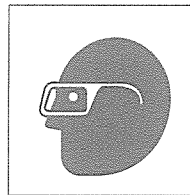

Wear eye protection

Wear a rubber apron and rubber gloves when working with corrosives. Wear gloves and safety shoes when handling wooden blocks or sharp-edged metal.

Always use safety glasses, goggles or a face shield. They provide eye protection from fluids under pressure, during grinding and while servicing batteries. Protection is also needed from flying debris, liquids and loose material produced by equipment, tools and pressurized air/water.

Wear a face shield and follow manufacturer's instructions when you disassemble spring-loaded components or work with battery acids. Keep pockets free of all objects that could fall out and drop into machinery.

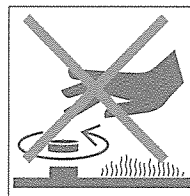

Do not loosen radiator cap until cool

Handle tools and heavy parts sensibly, with regard for the safety of yourself and others. Lower items; don't drop them.

Prepare the Work Area

- Position the machine in a level area out of the way of other working equipment.
- Make sure there is adequate light, ventilation and clearance.
- Remove oil, grease or water to eliminate any slippery surfaces.
- Clean around the area to be serviced to minimize contamination.

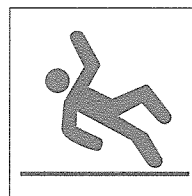

Avoid falls, clean slippery surfaces

Perform Maintenance Safely

Prepare the Machine

Stored energy sources (electrical, mechanical, hydraulic, pneumatic, chemical, thermal, etc.) must be controlled or reduced to a practical minimum before performing any maintenance, repair or service procedures.

Safety practices to prevent potential injuries from energy-releasing sources include:

- Place controls in NEUTRAL or LOCKED position before shutting off engine.
- Set parking brake or block wheels.
- Allow all moving parts to stop.
- Shut off engine.
- Relieve hydraulic system pressure by moving controls several times in all directions.
- Lock ignition, remove key (if equipped) and take it with you.
- Look and listen for evidence of moving parts before dismounting.
- Shut off master electrical switch (if equipped).
- Securely support or block up machine before working underneath machine or other lifted components.
- Securely support, block up, or lock up other components with approved locking devices before working near or underneath them.
- Relieve pressure before disconnecting or disassembling any pressurized system.
- Block or relieve spring pressure before disassembling any spring-loaded mechanism.
- Avoid flames, sparks, or smoking near any fuel, hydraulic fluid or other flammable material such as spraying debris.

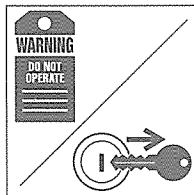

Use a "DO NOT OPERATE" tag

Attach a "DO NOT OPERATE" warning tag to the control levers. Lock out the unit according to the manufacturer's operating manual. If there is a key, remove it and take it with you.

Install approved support device(s) when working under or near raised equipment.

⚠ WARNING! Unsupported raised machines or other equipment may drop unexpectedly. **Never go under equipment when raised unless supported by an approved support device(s).** Death or serious crushing injury could result from falling equipment.

Remove only guards or covers that provide access to the area being serviced. Replace all guards and covers when work is complete.

⚠ WARNING! Avoid injury or death. **Never work on machinery with the engine running unless instructed by the manufacturer's manuals for specific service.**

Common Maintenance Safety Practices

Use Proper Ventilation

If it is necessary to run an engine in an enclosed area, remove the exhaust fumes from the area with an exhaust pipe extension.

If you do not have an exhaust pipe extension, make sure you open doors and windows to get plenty of outside air into the area.

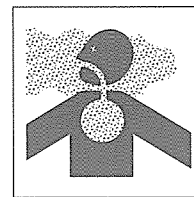

Ventilate work area

⚠ WARNING! Exhaust fumes contain carbon monoxide which could be deadly if inhaled. **Never operate any type of engine without proper ventilation.** EXHAUST FUMES CAN KILL.

Use Jacks and Hoists Carefully

Safety stands or blocks must be located on a rigid part of the machine. Do not position stands under axles or wheel supports that may rotate.

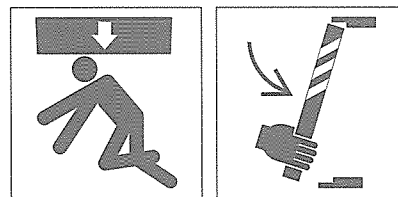

Avoid crushing, use proper support for raised equipment

⚠ WARNING! Prevent crushing injury. **Never use concrete blocks for supports. They could collapse under even light loads.**

If you must work beneath raised equipment, always use wood blocks, jack-stands or other rigid and stable supports. When using jacks or hoists always be sure they are adequately supported.

Make sure the hoists or jacks you use are in good repair. Never use jacks with cracked, bent, or twisted parts. Never use frayed, twisted or pinched cables. Never use bent or distorted hooks.

Perform Maintenance Safely

Fuel Hazards

⚠ WARNING! Avoid serious injury or death. **Always use approved fuel containers and/or fuel dispensing equipment to reduce the risk of explosion or fire.**

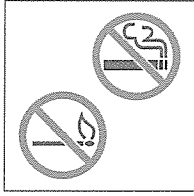

No smoking and no open flames

Always observe these practices to reduce the possibility of a serious accident:

- Shut off engine and ignition during refueling.
- Always ground the fuel nozzle against the filler neck to avoid sparks.
- Keep sparks and open flames away from fuel.
- Do not smoke while refueling or when handling fuel containers.
- Do not cut or weld on or near fuel lines, tanks or containers.
- Do not overfill the tank or spill fuel. Clean up spilled fuel immediately.

Ultra-Low Sulfur Diesel (ULSD) Hazard

⚠ WARNING! Ultra-Low Sulfur Diesel (ULSD) poses a greater static ignition hazard than earlier diesel formulations. Avoid death or serious injury from fire or explosion; **consult with your fuel or fuel system supplier to ensure the delivery system is in compliance with fueling standards for proper grounding and bonding practices.**

Engine Coolant Hazards

⚠ WARNING! Avoid serious injury or death. Liquid cooling systems build up pressure as the engine gets hot, so **use extreme caution before removing the radiator cap.**

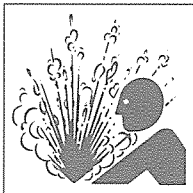

Remove radiator cap slowly

- Stop the engine and wait for the system to cool.
- Wear protective clothing and safety glasses.
- Turn the radiator cap slowly to the first stop to allow the pressure to escape before removing completely.

Hydraulic System Hazards

Be sure to follow manufacturer's instructions for relieving fluid pressure before performing any maintenance. The hydraulic system is pressurized whenever the engine is on and may hold pressure even after the engine is shut off. Cycle hydraulic controls, including auxiliary hydraulic control (if equipped), after the engine is shut off.

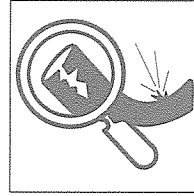

Check for leaks and inspect hoses

During inspection of the hydraulic system:

- Wait for fluid to cool before disconnecting the lines. Hot hydraulic fluid can cause **SEVERE BURNS**.
- Wear appropriate eye protection. Hydraulic fluid can cause permanent eye injury.
- When venting or filling the hydraulic system, loosen the filler cap slowly and remove it gradually.
- **Never** reset any relief valve in the hydraulic system to a pressure higher than recommended by the manufacturer.

Hydraulic Fluid Injection Hazard

⚠ WARNING! Accidental injection of high-pressure oil into the hands or body is dangerous and could result in death or serious injury. **Use caution when checking hydraulic leaks as pressurized hydraulic fluid has enough force to penetrate skin, causing serious personal injury.**

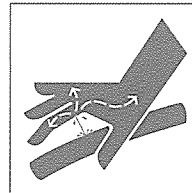

High pressure fluid can inject into the body

If a leak is discovered:

- Ensure engine is turned off; relieve pressure in hydraulic circuit.
- Wear proper hand and eye protection.
- Visually examine the hydraulic hoses or fluid lines in the vicinity of the leak for breaks or cracks. **Do not** use your hand to check for leaks.
- Repair or replace hydraulic lines according to the manufacturer's recommendations.

Perform Maintenance Safely

Fluid injection injuries are not always obvious. Victims have reported such injuries feel like a bee sting or splinter under the skin. If you suspect you have a fluid injection injury, do not take chances. Seek proper medical care immediately. If any fluid is injected into the skin, it must be surgically removed within a few hours by a doctor familiar with this type of injury.

Electrical System Hazards

Light Bulbs and Illumination

Some machines are equipped with High-Intensity Discharge (HID) Xenon light bulbs which operate at very high voltage. Do not begin installation of HID-Xenon lamps unless the lamps are turned off, the engine is turned off, the key is removed (if equipped), and you are wearing appropriate eye protection.

⚠ WARNING! Do not look directly into HID-Xenon lamps. Eye damage could occur.

Wear gloves and safety glasses when handling bulbs. Dangerous voltage sparks may occur and cause injury or damage to the connector. See manufacturer's warnings packaged with replacement bulbs.

Before working on the electrical system, disconnect the battery cable(s).

- Remove the battery negative (-) cable(s) first.
- When reconnecting the battery, connect the battery negative (-) cable(s) last.

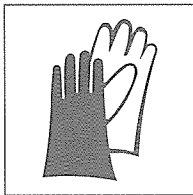

Wear hand protection

Battery Hazards

The liquid in batteries contains acid, which is a POISON and could cause SEVERE CHEMICAL BURNS.

Avoid injury:

- Wear a face shield to prevent contact with your eyes.
- Wear chemical-resistant gloves and clothing to keep electrolyte off your skin and regular clothing.

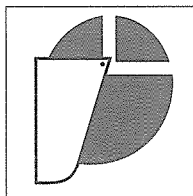

Wear face protection

⚠ WARNING! Electrolyte will damage eyes or skin on contact. **Always wear a face shield to avoid electrolyte in eyes.**

If electrolyte contacts eyes, flush immediately with clean water and get medical attention. **Wear chemical-resistant gloves and protective clothing to keep electrolyte off skin.** If electrolyte contacts exposed skin or clothing, wash off immediately with clean water. **If electrolyte is ingested,** drink large quantities of water or milk. **DO NOT** induce vomiting. Seek medical attention immediately.

Avoid Explosion

⚠ WARNING! Avoid serious injury from explosion. Lead-acid batteries produce extremely explosive gases especially when being charged. **Keep arcs, sparks, flames and lighted tobacco away.**

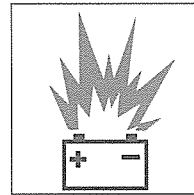

Avoid sparks and open flames near batteries

- **Do not** smoke near batteries.
- Keep them away from arcs, sparks and open flames.
- Provide adequate ventilation.

Never check the battery by placing a metal object across the battery posts. The resulting spark could cause an explosion.

⚠ WARNING! Avoid serious injury from battery explosion. **Do not charge a battery or jump-start the engine if the battery is frozen.**

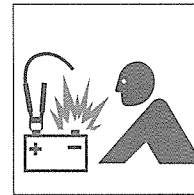

When jump-starting, observe polarity and make final connection at ground point

Warm to 60°F (15.5°C) or the battery may explode and could cause serious injury.

Safety rules during battery jump-starting:

- Follow the instructions for proper battery jump-starting, as specified in the manufacturer's manual.
- Be sure the machines are not touching.
- Observe the polarity of the batteries and connections.

Perform Maintenance Safely

- Make the final cable connection to the engine or the furthest ground point away from the battery. Never make the final connection at the starter or dead battery. Sparks may ignite the explosive gases present at the battery.
- When disconnecting cables, remove the cables in reverse order of connection (e.g., final connection first).

Tire and Wheel Maintenance

Check your tires and wheels daily because the stability of the machine can be dramatically affected by tire pressure or damage to tires or wheels.

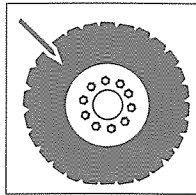

Check tires and wheels for damage

Check tires for:

- Correct pressure.
- Cuts and bulges.
- Nails or other punctures.
- Uneven or excessive wear.
- Condition of valve stems and caps.

Check wheels for:

- Damage to the rims.
- Missing or loose lug nuts or bolts.
- Misalignment.

All tire service should be performed by a qualified tire service center or by an authorized service person who has been properly trained in the procedures and use of safety equipment designed for tire servicing.

⚠ WARNING! The types of wheels and tires usually found on this equipment require special care when servicing to prevent death or serious injury. **Do not inflate the tires above the recommended pressure.**

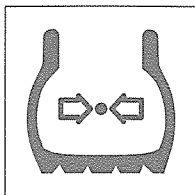

Maintain proper tire pressure

Keep wheel lug nuts tightened to manufacturer's recommendations.

An increase in tire pressure during operation is normal, and should NOT be reduced.

Never reinflate a tire that has been run flat or seriously under-inflated without removing the tire from the wheel.

Have the tire and wheel closely inspected for damage before remounting.

When adding air to a tire, do so from a distance. Always use a long hose with a self-attaching chuck; stand away from the tire sidewall and to one side as far as possible.

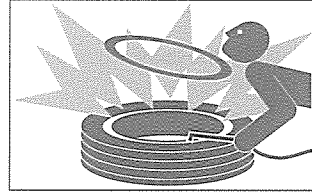

Avoid tire explosion

Do not inflate tires with flammable gases or from systems using an alcohol injector.

Never cut or weld on a wheel with an inflated tire mounted on it. This could cause explosive decompression.

Check that the tire size and wheel are correctly matched.

When replacing the tires, ensure the tires are of the appropriate rating specified by the manufacturer.

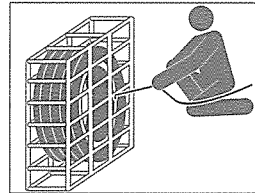

Use safety devices when reinflating tires

⚠ WARNING! Avoid death or serious injury. **Always use a safety cage or cable restraints when reinflating a repaired tire.**

Tires should not be operated at speeds higher than their rated speed.

Track Maintenance

Track tension is important for good track performance, reducing excessive track wear and preventing tracks from derailing.

Tracks under tension can store an incredible amount of energy, and although some machines have automatic track tensioners, special tools and procedures may be required to check or adjust track tension.

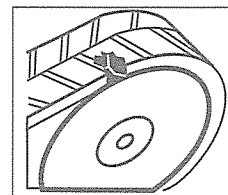

Check for track damage

Perform Maintenance Safely

Removing and installing tracks also requires following safe and proper servicing procedures. Always follow the manufacturer's instructions for track maintenance and servicing, including adjusting track tension.

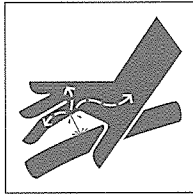

**High pressure fluid
can inject into
the body**

⚠ WARNING! Most track tensioning systems have compressed springs or pressurized fluid (oil or grease). **Improperly releasing track tension forces could cause serious injury or death.** Always follow the manufacturer's warnings and instructions for track adjustment and other maintenance and servicing procedures.

Roll-Over Protective Structure (ROPS) and Falling Object Protective Structure (FOPS) Safety Precautions

Do not remove the ROPS/FOPS except for service. Reinstall them correctly before allowing the machine back into service.

Do not modify ROPS/FOPS in any manner. Unauthorized modifications such as welding, drilling, cutting or adding attachments could weaken the structure and reduce your protection. Replace ROPS/FOPS if subjected to rollover or damage. Do NOT attempt to repair them. See the manufacturer's manual(s) for complete instructions and inspection requirements.

Complete Service and Repairs Before Machine is Released

Tighten all bolts, fittings, and connections to torques specified by the manufacturer.

Are there any missing cotter pins, washers, locknuts, etc.? Are there any parts left over?

Start the engine and check for leaks. (See page 19, **Hydraulic System Hazards**.) Operate all controls to make sure the machine is functioning properly. Test the machine if necessary. After testing, shut down and check the work you performed.

Recheck all fluid levels before releasing the equipment for operation.

All parts should be inspected during repair and replaced if worn, cracked or damaged. Excessively worn or damaged parts could fail and cause injury or death.

Install all guards, covers, and shields after servicing. Refill and recharge pressure systems only with manufacturer-approved or recommended fluids.

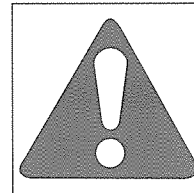

**Verify service work
when completed**

Final Word to the User

You have just finished reading the AEM Skid Steer Loader Safety Manual. It is impossible for this manual to cover every safety situation that you may encounter on a daily basis. Your knowledge of these safety precautions and your application to the basic rules of safety will help to build good judgment in all situations. Our objective is to help you develop, establish and maintain good safety habits to make operating a skid steer loader easier and safer for you.

This manual is one in a series on the safe operation of machinery, published by AEM.

Operating Instructions

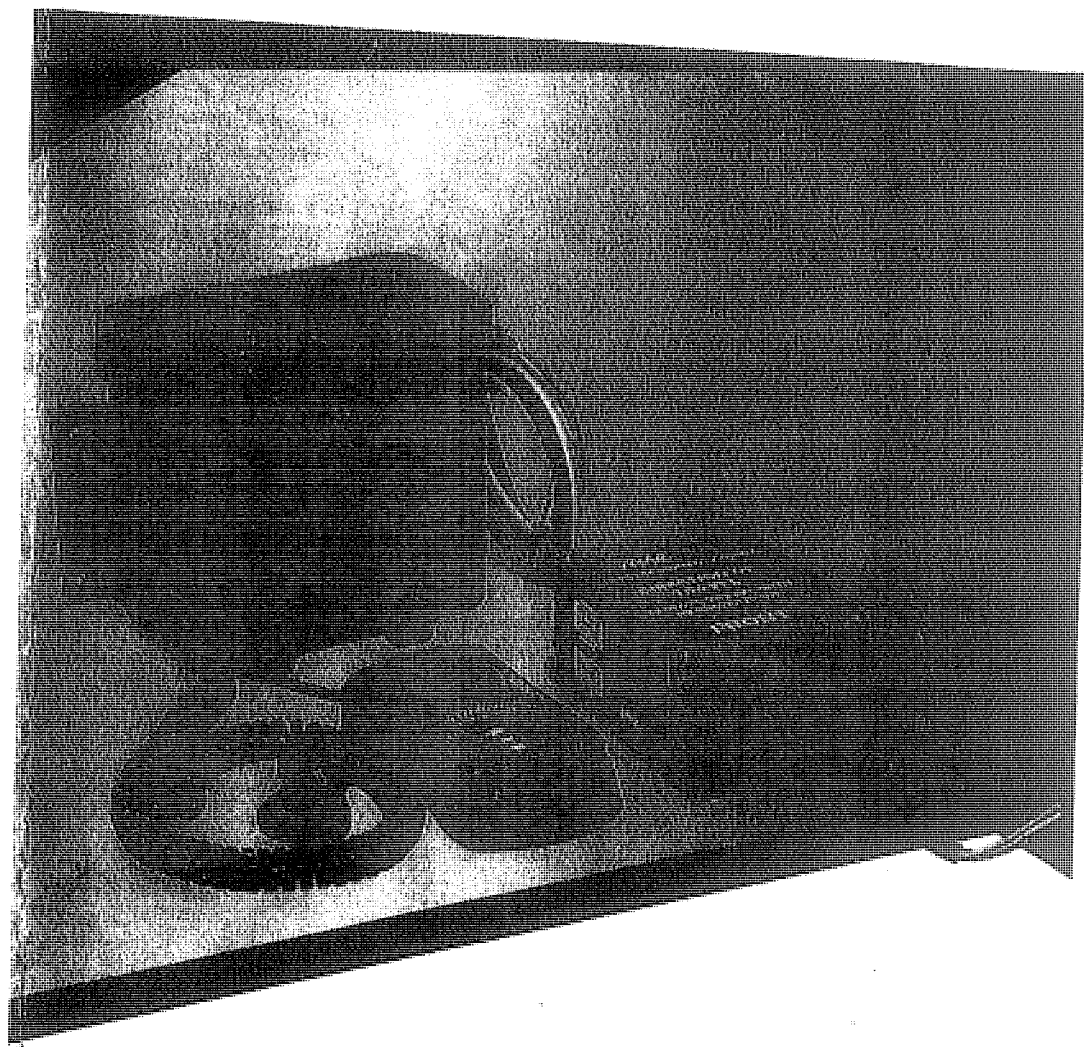

Installation Instructions

Mount the Brake controller according to the mounting orientation instructions on page 4.

Wire the brake controller according to the instructions below.

It is important that trailers fitted with the SE braking system are also fitted with 12/24 volt LED lights, not voltage specific incandescent or LED lights.

The controller is capable of running trailers with up to 6 wheels braked with electric drum brakes.

The earth from the trailer brakes and the trailer battery must only connect to the brake controller output earths as shown in the diagram. They cannot be connected to a common chassis earth.

Cable gauge should be of sufficient size to avoid voltage drop. For electric drum brakes a minimum of 15 amp cable should be used and a separate feed should be run per two wheels that are fitted with brakes.

The trailer lights must only be connected to the 5 core lighting output from the controller and cannot bypass this directly to the trailer plug.

There is a spare orange wire that is not used when installing on a trailer fitted with electric drum brakes. This can be cut short if desired.

Electric Drum Wiring Diagram

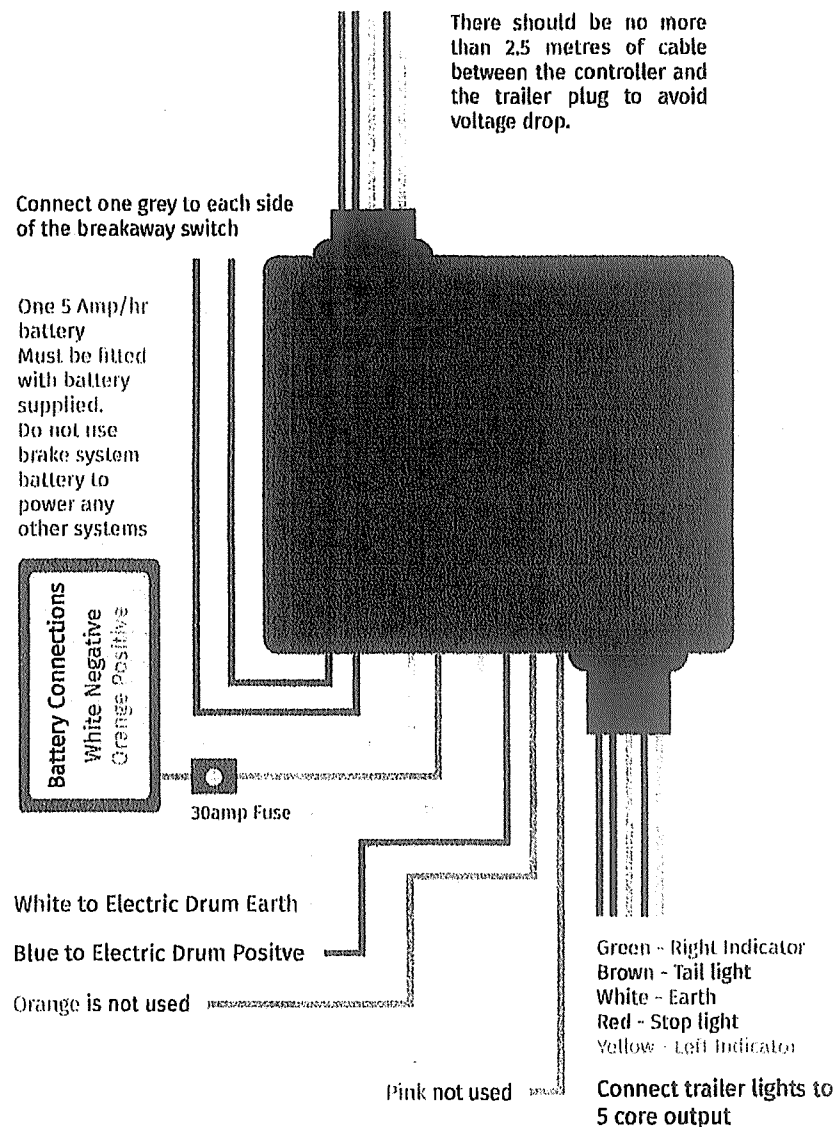

Mounting Orientation

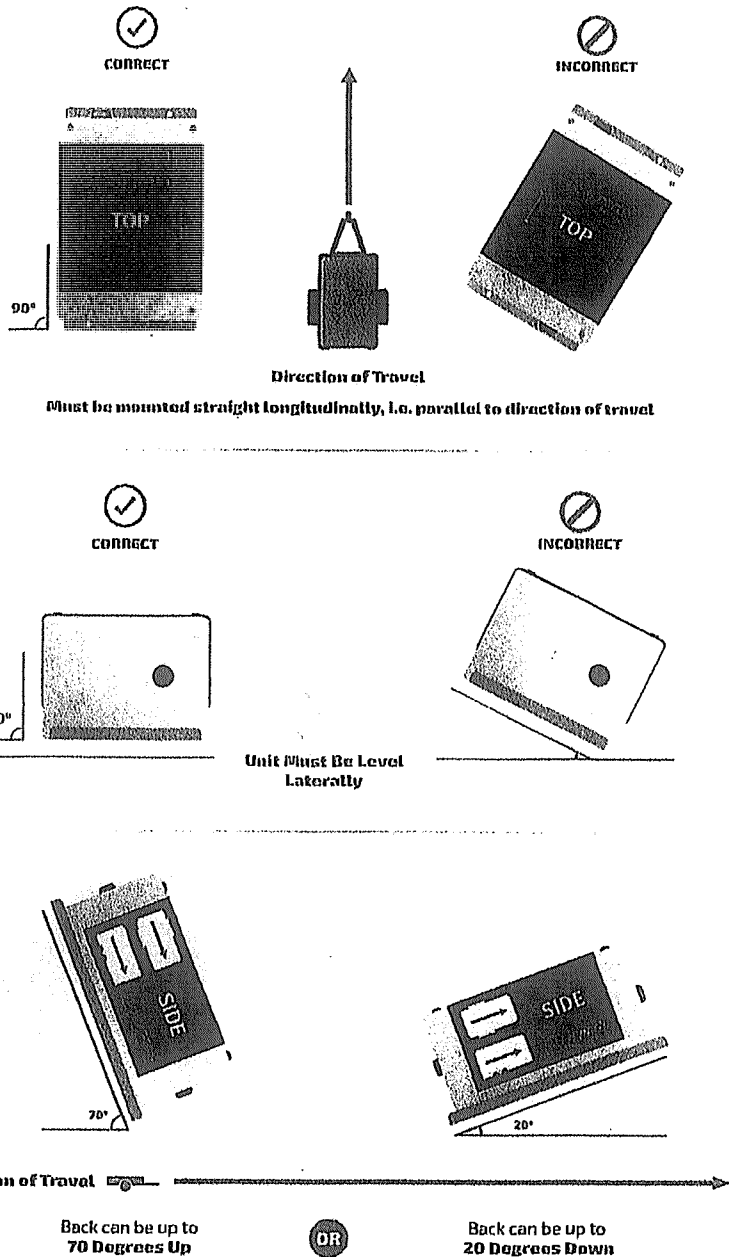

Cab Controls

- 1 **Emergency Brake** – When activated, this will apply the trailer brakes at 75% of the current gain setting. This can be used to control trailer sway situations and stop the vehicle combination in an emergency.
- 2 **Gain Control – Adjusting Gain Control:** The plus button will increase the maximum brake percentage, and the minus button will decrease it. This should be set so the vehicle will brake to a halt without the trailer wheels locking up. An effective benchmark is to perform a brisk stop on a straight flat stretch of road from 30 kph. The vehicle trailer combination should halt without the trailer wheels locking. Increase or decrease the gain setting until the trailer is braking at just under the lock up level. Ensure conditions are safe around you before carrying out this procedure.
- 3 **Sensitivity Control** – This will control how quickly and aggressively the brakes will activate, with 1 being the least and 5 the most aggressive. Pressing this will advance the setting from 1 up to 5 and then back to 1. Setting this to 3 will provide mid-range braking. Decrease this setting to 2 or 1 if brakes come on too suddenly. Increase this setting if braking action seems too slow.

4 **Screen** – This will provide feedback about the operation of the controller and warn of any faults that might occur.

- A **Normal operation** – Head lamps on, no brake applied.
- B **Brake Applied** – When sitting still this will show a braking level around 0% - 5%. When travelling this will show a percentage from 0% up to 99% depending on the level of braking and the current gain setting.
- C **Ec Error** – If this shows with a slow steady beep it indicates your headlamps are not on or if they are that there is a loss of communication between the trailer and cab modules. In the event of communication loss, providing the headlamps are on and the lighting connection between the tow vehicle and the trailer is not faulty the brakes will continue to operate at the last setting. This should however be investigated as soon as it is safe to stop.
- D **Eb error** – The unit will beep 4 times and flash Eb in the event of the battery charge dropping below an unsafe level, meaning that the brakes may not operate correctly.

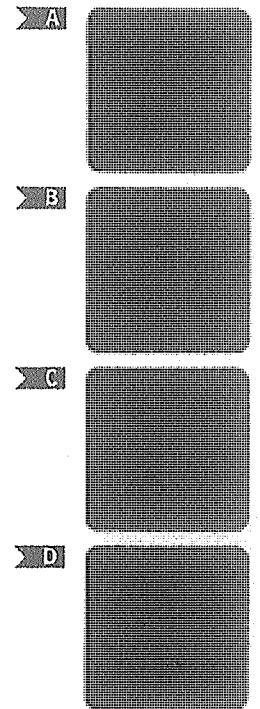

Note: Both the trailer and the cab modules of the brake controller are compatible with 12 and 24 volt vehicles.

Operating Instructions

The SE Braking system meets Australian Design Rules 38 braking regulations and is legal for trailers up to 4500kg GVM when used according to these instructions.

Operation

- The in cab controller must be connected at all times and located within easy reach of the Driver.
- The Vehicle park, or head-lights must be switched on when towing the trailer. This energises the trailer side of the system and also will allow the trailer batteries to charge.
- Check the plug and socket of the trailer and tow vehicle are securely connected and that the trailer lighting functions all work correctly. A faulty or intermittent lighting connection could mean the brakes do not operate correctly.
- Ensure the break away cable is securely fastened to the vehicle.
- Test the emergency brake is working. First adjust the gain control setting to read 75%. Depress emergency stop button fully, and begin to pull forwards while still holding the button down. The trailer brakes should lock the wheels.
- Do not use the emergency stop feature or breakaway function as a parking brake.

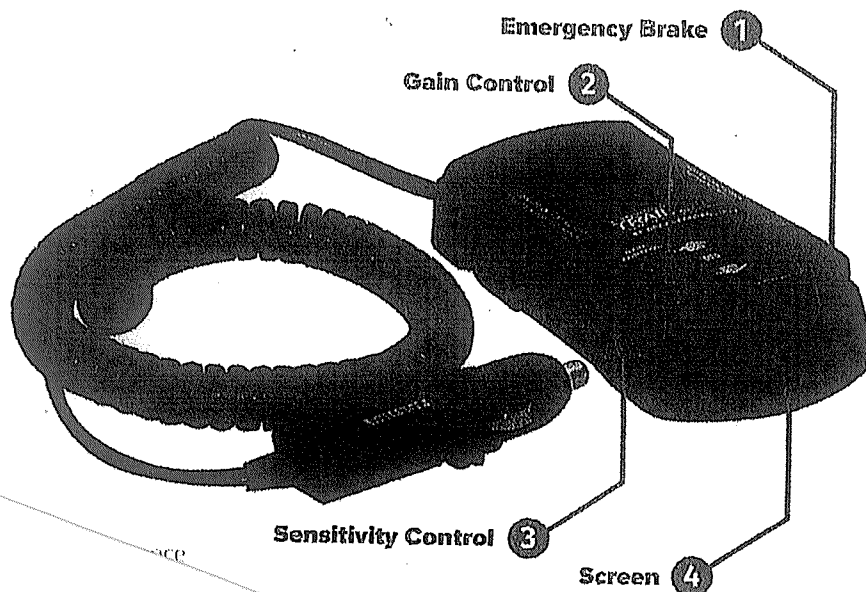

Periodic Maintenance and Checks

Check battery is keeping well charged. A well charged battery should be at or above 13 volts. This is particularly important if the trailer is left parked for extended periods of time. If the trailer is not used for extended periods the battery should be removed every 2 months and charged to ensure it does not become damaged. This can happen if the battery charge drops below 10.5 volts.

Check the trailer plug and vehicle socket to ensure they are not damaged and they give a sound electrical connection. An intermittent or faulty connection could mean the brakes do not function correctly.

If fitted with a hydraulic actuator make sure the fluid level remains sufficient. The fluid should be changed in line with general trailer service intervals.

If fitted with electric drums make sure they are kept properly adjusted and that the magnets and linings are not excessively worn and are replaced in line with general trailer service intervals.

Other Information

The trailer and cab parts of the controller are uniquely paired together by their serial numbers. The serial number is a 3 or 4 digit number and is located on the bottom of the cab unit and is stamped on the front of the alloy mounting plate of the trailer unit.

Available from VENTA Pty Ltd.
Phone us on 1300 538 598

For More Information
www.trailequip.co.nz

Owner's Manual

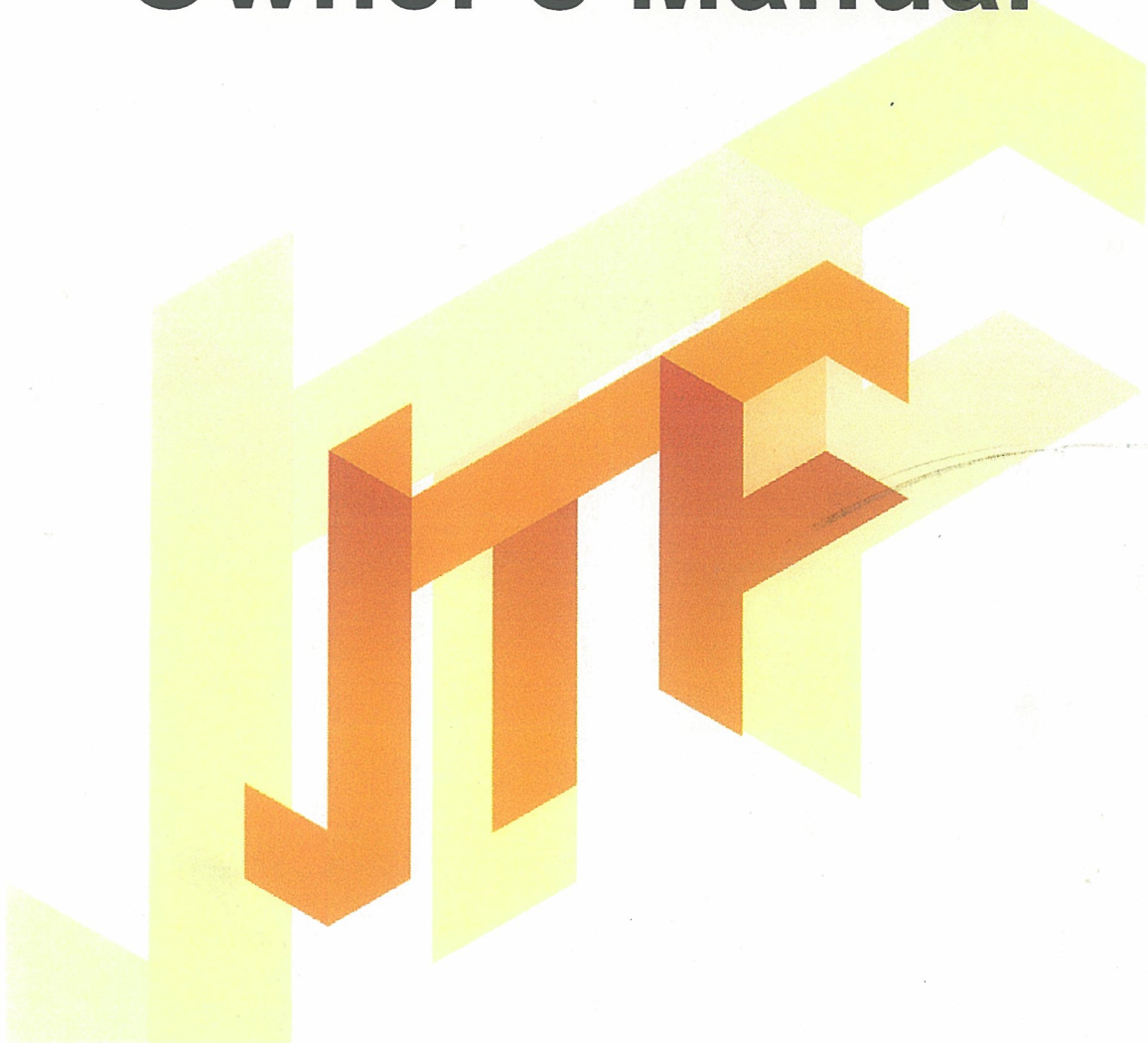

Jimboomba Trailers and Fabrication Pty Ltd

ABN: 86267711065 ACN: 148052671

74 High Road, Bethania QLD 4205

Ph 07 3200 2427 Fax 07 3200 9331 Email: info@jtf.net.au

www.jtf.net.au

This manual is the property of Jimboomba Trailers and Fabrication Pty Ltd

Owner's Manual - JTF-MAN-01

Issue 0916

Introduction

Acquisition & Warranty

Record below the serial number of your trailer and keep it in a secure place to help trace the trailer and assist us when you order parts.

Model	
Month/Year of Manufacture	
Serial Number (VIN)	
Original Owner (name and address)	
Delivery Date	
Purchased through what Dealer	

This Document contains the Original Operating Instructions for this machine and is verified by the Manufacturer.



JTF Director

Disclaimer

Every effort has been made to ensure that the information in this manual was accurate and up to date at the time of going to print. JTF reserves the right to make subsequent changes to the trailers, where necessary, without notification.

The Company will not be responsible for any damage or consequential loss arising out of misinterpretation or failure to follow recommended procedures. Nor will it be liable for any damage caused by or arising out of modification or misuse of its product.

The owner has a responsibility to protect himself and others by observing all safety information and road regulations and by ensuring all operators are well acquainted with the safety information, trained in the correct use of the trailer and applying safe work practices.

The Owner's Manual

Your new JTF Trailer will give long and efficient service if serviced regularly and operated as intended.

This owner's manual is provided so that you can become thoroughly familiar with the design of the trailer and to provide information on the correct operation, applicable adjustment and maintenance.

Only persons well acquainted with these guidelines should be allowed to use the equipment.

A general parts list has been included in this document so that if any parts are required your dealer will be able to suitably describe the item and request them by part numbers.

The manual is considered part of the trailer and must be issued when the trailer is sold.

Right and left hand references in this manual are determined by standing behind the trailer and facing in the direction of travel.

Trailer Type and Usage

JTF Supply and manufacture a variety of plant and equipment trailers to suit a range of private and commercial application in both steel and aluminum. This document will identify a number of standard and common features to assist in the operation of your trailer. If a particular feature is not made mention for please contact the manufacturer for instruction or clarification.

Our standard product/ model range includes;

JTF-A001-2T	2T ALUMINIUM EXCAVATOR TRAILER (form bent) 2100X1140 (drive up)
JTF-A002-2T	2T ALUMINIUM SKID STEER TRAILER (Suit S70) (form bent) 2100x1500
JTF-A003-2T	2T ALUMINIUM ROLLER & SCISSOR LIFT TRAILER (form bent) 2100X1140
JTF-A004-2T	2T ALLOY JTF MINI LOADER TRAILER (a-frame) 3000X1500 w beavertail
JTF-A005-2.8T	2.8T ALLOY JTF MINI LOADER TRAILER (a-frame) 3000X1500 w beavertail
JTF-A006-2.8T	2.8 Tonne ALUMINIUM EXCAVATOR TRAILER (form bent) 2100X1140 (drive up)
JTF-A007-3.5T	3.5T ALUMINIUM EXCAVATOR TRAILER (form bent) 2400X1850
JTF-A008-3.5T	3.5T ALUMINIUM MACHINE TRAILER (a-frame) 4000X1850
JTF-A009-4.5T	4.49T ALUMINIUM MACHINE TRAILER (a-frame) 4000X1850
JTF-S001-1.4T	1.4t Single Axle Steel Excavator Trailer (form bent) 1000X1500 (plus bucket mount)
JTF-S002-1.8T	1.8T STEEL RANGER TRAILER (a-frame) 3600x1900 w beavertail
JTF-S003-2T	2T JTF MINI LOADER TRAILER (a-frame) 3000x1500 w beavertail
JTF-S005-2.8T	2.8T STEEL JTF MINI LOADER TRAILER (a-frame) 3600x1500 w beavertail
JTF-S006-2.8T	2.8T STEEL MACHINE TRAILER (form bent) 3000x1500 (sloped deck)
JTF-S007-3.5T	3.5T STEEL MACHINE TRAILER (a-frame) 4000x1900 w beavertail
JTF-S008-4.5T	4.49T STEEL MACHINE TRAILER (a-frame) 4000x1900 w beavertail
JTF-S009-7T	TANDEM AXLE PLANT TRAILER (JTF 7T PLANT) (a-frame) 500x2250 w beavertail
JTF-S010-9T	TANDEM AXLE PLANT TRAILER (JTF 9T PLANT) 6000x2250 w beavertail

*If the trailer you have purchased is outside the above range then any additional information will be provided for on the point of delivery but may not be specifically mentioned within this document.

Manufacturer Advised Capacities

Trailers are built with a reference to ATM; this is by definition is 'Aggregated Trailer Mass'. This is total mass of the trailer when carrying the maximum load recommended by the manufacturer.

As the operator you are responsible for the load you are carrying and must consider the operating weight of your cargo or equipment before loading and or towing. It is also recommended that you reference your tow vehicles operating manual for safe towing requirements for tow limits and limitations.

Please refer to the plate attached to your drawbar for specifics on your trailers capacities.

General Capacities are as follows;

Component	Maximum Capacities (manufactures guidance- estimated)
JTF-A001-2T Ramps	Combined capacity not exceeding 1.86tonne
JTF-A002-2T Ramps	
JTF-A003-2T Ramps	
JTF-A004-2T Ramps	
JTF-A005-2.8T Ramps	Combined Capacity not exceeding 2.4tonne
JTF-A006-2.8T Ramps	
JTF-A007-3.5T Ramps	Combined Capacity not exceeding 2.9tonne
JTF-A008-3.5T Ramps	
JTF-A009-4.5T Ramps	Combined Capacity not exceeding 3.6tonne
JTF-S001-1.4T Ramps	Combined Capacity not exceeding 1tonne
JTF-S002-1.8T Ramps	Combined Capacity not exceeding 1.4tonne
JTF-S003-2T Ramps	Combined Capacity not exceeding 1.5tonne
JTF-S005-2.8T Ramps	Combined Capacity not exceeding 2.1tonne
JTF-S006-2.8T Ramps	
JTF-S007-3.5T Ramps	Combined Capacity not exceeding 2.5tonne
JTF-S008-4.5T Ramps	Combined Capacity not exceeding 3.2tonne
JTF-S009-7T Ramps	Combined Capacity not exceeding 4.7tonne
JTF-S010-9T Ramps	Combined Capacity not exceeding 6.5tonne
*Auger Power Drive attachment mount (standard)	Capacity not exceeding 75kg
*Trencher attachment mount (industry average)	Capacity not exceeding 110-175kg
*Augers attachment mount (pending size) (industry average)	Capacity not exceeding 35-65kg
*Leveller Bar attachment mount (industry average)	Capacity not exceeding 100kg
*Rock Breaker attachment mount (industry average)	Capacity not exceeding 120-175kg
*4 in 1 Bucket attachment mount (industry average)	Capacity not exceeding 165kg
185/14LT Tyre	850kg per tyre (some variation between brands)
195/14LT Tyre	950kg per tyre (some variation between brands)
225/75 R 15"	880-975KG per tyre (some variation between brands)
225/75 R 16"	880-975KG per tyre (some variation between brands)
235/75 R 15"	880-975KG per tyre (some variation between brands)
235/75/R 16"	880-975KG per tyre (some variation between brands)
235/75/R17.5	2800kg per tyre (some variation between brands)
Swing Up Jockey Wheel 8" wheel	Rated Maximum Capacity 350kg
Swing Up Jockey Stand	Rated Maximum Capacity 350kg
Bull-Dog Trailer Jack	Rated Maximum Capacity 4500kg

*these are industry averages and are used as a guide only

SAFETY – General

This section of the manual offers general guidelines for the safe operation of the trailer rather than specific hazards. It does not replace local safety regulations or road regulations. These guidelines were current at the time of publication, but may be superseded by later regulations. JTF has made every effort to highlight all risks to personnel or property. Owners and operators have a responsibility to exercise care and safe work practices at all times in the vicinity of the trailer. Owners are advised to keep up to date on safety issues and to communicate these to all users of the trailer. If you have safety concerns specifically related to this trailer, contact your dealer immediately.

Under no circumstances are passengers to be permitted on the trailer while it is in operation or being transported. Any footboards and/or footsteps are provided solely for the purpose of preparing the trailer for use.

Keep clothing and body extremities well clear of pinch points while operating the trailer. Keep well clear of moving parts at all times. These include couplings, ramps brackets, wheels, brakes and pivot points, etc.

Always exercise extreme caution in the vicinity of sharp edges and points.

Footboards, footsteps, drawbars and other machine surfaces may be slippery when wet. Apply extra caution in wet conditions and in the early morning when surfaces are wet

SAFETY – Towing

Apart from the driver's legal responsibilities, towing requires a greater degree of knowledge and skill than normal driving.

When towing, you should:

- ✓ Allow for the extra length and width of the trailer when entering traffic;
- ✓ Apply the accelerator, brakes and steering smoothly and gently to avoid sway, especially in wet or slippery conditions;
- ✓ Maintain a space of at least 60 metres between you and the vehicle in front to allow for a longer stopping distance;
- ✓ Engage a lower gear in both manual and automatic vehicles to increase vehicle
- ✓ Allow more time and a greater distance in which to overtake. When towing, your vehicle's capacity to accelerate is reduced;
- ✓ If possible, reverse with a person watching the rear of the trailer;
- ✓ Where areas are provided, pull off the road to allow traffic building up behind you to overtake;
- ✓ Be aware that towing is more stressful than normal driving and is more likely to cause fatigue. Therefore, more rest stops should be planned.

The loaded mass of your trailer must not exceed:

- ✓ The capacity of the towbar; or
- ✓ The maximum towing mass specified by the tow vehicle's manufacturer; or
- ✓ The trailers manufactures guidance

- ✓ Due consideration needs to be given when loading the machine or equipment onto the trailer and it is recommended you following the trailer manufactures guidance as to the load direct of the equipment
- ✓ Tow ball height on the tow vehicle is also a critical consideration (see below)



Safety - Operator

All trailers are potentially dangerous and should be treated with caution and respect.

It is strongly suggested that you carefully read this before operating the new equipment. Learn how to use this trailer safely. Be thoroughly familiar with the controls and the proper use of the trailer before using it. Take careful note of all safety instructions both in this manual and on the trailer itself. Failure to comply with instructions could result in personal injury and/or damage to the trailer. It is recommended that you periodically replace missing or damaged safety signs on the trailer to ensure that these remain clearly visible.

It is the owner's responsibility to ensure that anyone who operates, adjusts, maintains, cleans or uses the trailer in any way has had suitable instruction and is familiar with the information in this manual (particularly with regard to safety aspects general).

Operators and other users of the trailer should be aware of potential hazards and operating limitations.

Load Restraint

Please refer to the 'National Transport Commission (NTC) publication Load Restraint Guide'

www.ntc.gov.au/heavy-vehicles/safety/load-restraint-guide/

– 'Grade 70 Chain, Components & Load Binders' (AS/NZS 4344)

Appropriate Dress

Wear close fitting clothing and avoid rings or other forms of jewellery which could become caught on the trailer. People with long hair must have it securely fixed and confined close to the head. Please refer to local safety standards for protective clothing and recommended safety equipment.

Trailer in transit

Ensure that all linkage pins and clips are fitted correctly. Ensure the ramps are stowed accordingly and secured with pins or clips. When loading equipment or cargo ensure that the load is secured and meets Road Regulations (refer to Safe Towing – All about safe towing, Department of Transport and Main Roads and Load Restraint Guide from the National Transport Commission).

- A speed of 100km/h must not be exceeded.

Practice Safe Maintenance

Keep the trailer in safe working condition.

Routine maintenance and regular servicing will help reduce risks and prolong the life of the trailer.

These are the suggested minimum maintenance guidelines;

- ✓ You must visually inspect and check tension of all nuts, bolts, U-bolts and wheel bearings after the first two (2) hours of use. (Tension of nuts, bolts and U-bolts is recommended at 120 newtons)
- ✓ You must visually inspect and check the tension of all wheel nuts. It is vital that wheel nuts are inspected every 100km for the first 300km of use. This recommendation is also strongly encouraged at any time a wheel is removed and or replaced.
- ✓ Visually inspect and grease wheel bearings 3 monthly (strongly recommended).
- ✓ If fitted, brakes will require adjusting dependent on the load and tow vehicle.
- ✓ Brake components should be regularly inspected whether that is disc or electric. Trailers fitted with a break-away system will need to be visually inspected prior to every use, to ensure the independent battery is functioning and charged sufficiently.
- ✓ Suspension components should be visually inspected regularly (after every 100 hours of use is recommended).
- ✓ Inspect and adjust the coupling screw adjuster as required to suit tow vehicle tow ball.
- ✓ Do not store damp materials in or on the trailer. If possible it is recommended to store the trailer out of the elements when not in use.
- ✓ Do not use jockey wheel and or stand for transport or movement of trailer. Jockey wheel and or stand are to be used for hitching purposes only.
- ✓ Check the integrity of the trailer and areas of high wear for damage or stress

*Note: Suggested maintenance is the minimum recommended. If the trailer is being employed commercially then the intervals between inspections should be reviewed based on usage. For further information please contact the manufacturer.

Routine Maintenance

To ensure the safety and reliable operation of your suspension system the following routine maintenance is strongly recommended. The service periods recommended below are based on normal road usage. For commercial and or abnormal conditions maintenance intervals will need to be more frequent and daily visual inspections are recommended.

Maintenance should be carried out by a competent person.

The suspension, tyres and braking system has be fitted and selected according to the vehicle manufacturers recommended Aggregate Trailer Mass (ATM) which can be found on the vehicles compliance plate. It is important that these figures are not exceeded.

	1 st 100klm	1 st 300klm	1 st 1000klm	5000klm	10000klm	20000klm
<i>Wheel Nuts Tightened</i>	✓	✓	✓	✓	✓	✓
<i>Suspension and mounting bolts</i>	✓		✓			
<i>Suspension Bushes</i>	✓		✓			
<i>Wheel Bearings Checks</i>	✓		✓		✓	
<i>Wheel Bearings Service</i>				✓	✓	
<i>Check Brake mounting bolts</i>	✓	✓	✓	✓	✓	✓
<i>Brake Adjustment and Checks</i>	✓			✓	✓	
<i>Brake Service</i>		✓		✓		
<i>Wheel Alignment</i>				✓		✓
<i>Axle Mounting</i>				✓		✓

TIGHTNESS OF WHEEL NUTS

When a wheel is first fitted or removed there is an immediate settling in period where the wheels nuts will need retightening. Trailers tend to experience higher wheel loads than cars especially in tandem configuration and so extra effort should be taken to ensure wheel nuts remain tight.

Proceed as follows:

- ✓ Make sure the wheel and hub mating surfaces, as well as the wheel studs and nuts, are free of oil and all foreign material. Do not lubricate wheel studs.
- ✓ Using a wheel or air wrench, lightly tighten all the wheel nuts, in a criss-cross pattern, until they are snug.
- ✓ Using a torque wrench, tighten the wheel nuts in a criss-cross pattern to the vehicle manufacturer’s torque specification.

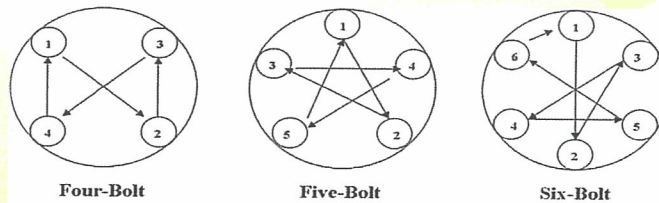

IMPORTANT: Torque settings may need to be reduced depending on wheel rim design and type. Please consult manufacturer or wheel supplier for recommended specifications to suit the wheels supplied with your trailer.

- Maximum torque is based on 80% of stud yield strength.
- Wheel nuts should be torqued using a calibrated torque wrench and checked at regular intervals as recommended above.
- Wheel nuts should be tightened in a diagonal (criss-cross) sequence as shown above.

Stud Size	Grade	Maximum Stud Torque (N.m)
7/16" UNF	SAE Grade 8	120
1/2" UNF	SAE Grade 8	200
9/16" UNF	SAE Grade 8	270
5/8" UNF	SAE Grade 8	375
M12x1.5	Class 10.9	155
M14x1.5	Class 10.9	245

SUSPENSION

Using a torque wrench check all bolts for tightness. Required torque settings given in Table 1 and Table 2 below.
 45mm Wide Springs - All bolts should be tightened until locked and then backed off until suspension is free to move but not loose.

Remove bushes, bolts, pins and spindles and inspect. Any parts showing signs of wear should be replaced. Smear a small amount of grease on bushes and outside of pins and spindles prior to reassembly. Torque all bolts in accordance with specifications below, ensuring that new nylon insert nuts are fitted where used.

Parabolic Suspension		
Bolt/Nut Size	Application	Torque (N.m)
1/2" x 3 1/2" Bolt UNC & 1/2" Nylon Insert Nuts	Single Leaf - Shackles & Hangers	200

Load Share - Suspension		
Bolt/Nut Size	Application	Torque (N.m)
9/16" x 3.5" Shackle Bolt & 9/16" Nylon Insert nut - 45mm Spring	Leaf Suspension - Shackles & Hangers	200
9/16" x 3.5" – Greasable Shackle Bolt & 9/16" Nylon – 45mm centre rocker	Leaf Suspension - Shackles & Hangers	200
5/8" X 4" Shackle bolt & 5/8" Nylon Insert Nut - 60mm Spring	Leaf Suspension - Shackles & Hangers	200
5/8" X 4" – Greasable Shackle Bolt & Nylon Nut – 60mm spring center rocker	Leaf Suspension - Shackles & Hangers	200

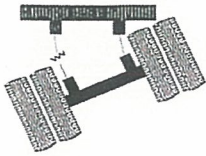

Loose suspension fasteners and worn parts may cause vehicle instability resulting in loss of control or upset.

Overtorquing could result in fastener failure.

5 TON MECH SUSPENSION AND AXLE TORQUE REQUIREMENTS

CHECK TORQUE VALUES AFTER "BREAK IN" PERIOD OF APPROXIMATELY 1000 TO 3000 MILES, (OR 1600 TO 4800 KILOMETERS) AND ANNUALLY THEREAFTER

U-BOLT NUTS, STEEL SPRINGS 5/8" UNF	177 ft-lb (240 Nm)
ROCKER BOX BOLT, M30x3.5P	885 ft-lb (1200 Nm)
REAR HANGER BOLT NUTS, M16X2P	7.5 ft-lb (10 Nm)
LEAF SPRING EYE BOLT, M20X2.5P	265 ft-lb (360 Nm)
CHECK WHEEL NUTS TORQUE SETTINGS	332 ft-lb (450 Nm)
MAKE SURE THE GREASE CAP IS TIGHT	
CHECK BEARING GREASE EVERY 12 MONTHS OR 100,000 KMS	
FOR BEARING ADJUSTMENTS, CHECK PERIODIC MAINTENANCE	
AT WWW.ABSTRAILQUIP.COM	

NOTICE: THESE SETTINGS MUST BE MAINTAINED AT ALL TIMES. VALUES ARE EXPRESSED IN ENGLISH UNITS, ft-lb=FOOT-POUNDS, AND METRIC UNITS, Nm=NEWTON-METERS

The torque figures quoted are approximate and are applicable to fasteners in a clean and un-lubricated condition, free from rust or corrosion. Correct pre-loading of the bolt resists the effects of fatigue. Providing that the bolt pre-load is greater than the applied load, the fatigue life of the bolt will be infinite.

Always remember that the best method for retaining a nut on a bolt is by regular inspections and proper tightening.

**Note we reserve the right to change the bolt and nut combination throughout the manufacturing cycle pending operational requirements*

BRAKES

At recommended intervals, inspect brakes, check operation, clean and adjust accordingly.

On hydraulic systems check condition of brake lines & hoses and check for signs of leaks on calipers and connection points. If you discover any worn items these should be replaced immediately

On disc brakes check the condition of the bolts, caliper and brake pads for wear and tear. If you discover any worn items these should be replaced immediately.

The electric brakes on your trailer are similar to the drum brakes on your car. The basic difference is that your vehicle brakes are actuated by hydraulic pressure whilst your electric trailer brakes are actuated by an electromagnet. The electrical current is fed into the system by the brake controller (in-car); it flows through the electromagnets into the brakes. The electromagnets are energized and are attracted to the rotating surface of the drums which moves the actuating levers in the direction that the drums are turning. The resulting force forces the primary shoe out against the inside surface of the brake drum. The force generated by the primary shoe acting through the adjuster link then moves the secondary shoe out into contact with the brake drum.

Therefore increasing the electrical flow (braking force) to the electromagnet makes the magnet grip tighter to the surface of the brake drum until the desired stop is accomplished.

Park Brake Operation - The brakes is mechanically operated by cable. The cable attachment occurs outside of the brake backing plate. Cable force applied to the parking lever operates a cam assembly which results in a spreading force between the primary and secondary shoes. In some circumstances some adjustment may need to be made to the brake cable when the trailer is under load.

Your trailer brakes are designed to work in synchronization with your tow vehicle brakes. Never use your tow vehicle or trailer brakes alone to stop the combined load.

Electric brake controllers provide a modulation function that varies the current to the electric brakes with the pressure on the brake pedal or amount of deceleration of the tow vehicle. It is important that your brake controller provided approximately 2 volts to the braking system when the brake pedal is first depressed and gradually increases the voltage to 12 volts as brake pedal pressure is increased.

Proper synchronization of tow vehicle to trailer braking can only be accomplished by road testing (when safe to do so). Brake lockup, excessive grabbing or harshness is quite often due to the lack of synchronization between the tow vehicle and the trailer being towed.

If the trailer brakes lock and slide, decrease the gain setting on the in-car controller. If they do not slide, try increasing the gain setting to the point of impending wheel skid. There should be no sensation of the trailer 'jerking' or 'pushing' the tow vehicle.

The trailer should not be breaking the towing vehicle otherwise overheating of the brakes and premature wear will occur.

Brake adjustments will also vary depending on the load being carried and road surface conditions. It is important to test and adjust the brake settings depending on the weight of the load being carried and or if the trailer is empty and not under load.

	1 st 100klm	1 st 300klm	1 st 1000klm	5000klm	10000klm	20000klm
Brake Adjustment & Check	✓	✓	✓	✓	✓	✓
Brake Service				✓	✓	

Your trailer brakes must be inspected and serviced at yearly intervals or more often as use and performance requires.

- ✓ Clean the backing plate, magnet arm, magnet and brake shoes.
- ✓ Inspect the magnet arm for any loose or worn parts.
- ✓ Check shoe return springs, hold down springs, and adjuster springs for stretch or deformation and replace if required.
- ✓ Magnets should be inspected and replaced if worn unevenly or abnormally.
- ✓ Visually inspect the brake linings and replace if the lining is worn (to within 1.6mm or less), contaminated with grease or oil, or abnormally scored or gouged.

WHEEL BEARINGS

After the first 1,000km of use we recommend you check for excessive bearing play and adjust if necessary.

Every 6 months or 10,000km we recommend that the wheel bearings should be dismantled and visually inspected. Lubricate with grease and replace bearings if they are showing signs of excessive wear and tear.

WHEEL ALIGNMENT

Visually inspect tires for abnormal wear. The suspension system is designed to have a small amount of negative camber at full load.

BRAKE TROUBLE SHOOTING

COMPLAINT	POSSIBLE CAUSE	REPAIR PROCEDURE
NO BRAKES	Open Circuit	Check for broken wires, loose connections. Improper grounding, faulty connector plug, between car and trailer, etc.
	Improperly wired or Inoperative Controller	Rewire Controller, check controller operation.
	Poor Brake Adjustment	Adjust brakes.
	Selective resistor defective	Check resistor for loose connections
	Worn or defective magnet	Replace magnet(s)
INTERMITTENT OR SURGING BRAKES	Short Circuit	Check electrical circuit.
	Out of round drums	Turn or replace drums
	Inadequate trailer ground	Check for proper grounding. (Note: aground through the trailer hitch is adequate)
	Broken magnet lead wires	Bench check magnets and replace if necessary
WEAK BRAKES	Loose wheel bearings	Check and adjust bearings
	Loose connections	Check that all connections are clean and tight.
	Inadequate trailer ground	Check for proper grounding.
	Short circuit	Check electrical circuit.
	Selective resistor setting incorrect	Check for proper setting to avoid too much resistance.
	Worn or defective magnets	Replace magnets (magnet power gets better with wear).
	Poor brake adjustment	Adjust brakes.
	Bent Backing plate	Check backing plate flange. Correct if necessary.
	Contaminated lining	Check and replace badly contaminated linings.
	Excessive load on trailer	Check to be sure trailer is not under braked. Also be sure to have brakes on every axle.
	Using trailer brakes only	Use of trailer brakes can cause early fade or loss of friction due to excessive heat.
GRABBING OR LOCKING BRAKES	Contaminated lining	Check and replace badly contaminated linings. Disconnect red wire on Controller.
	Controller not modulating	Disconnect red wire on Controller. Road test for braking modulation. If modulation is OK check the red wire. Bench test Controller and replace if necessary.
	Weak or broken springs	Check for weak or broken springs, and replace is necessary.
DRAGGING BRAKES	Electrical defect in controller	Insufficient gap between Controller contactor strip and coil may cause brakes to drag.
	Hydraulic defect in Controller	Excessive residual pressure in tow car hydraulic system or a 'gummed up' Controller cylinder may cause the Controller to be held on slightly.
	Badly corroded brake assembly	Check brake assemblies for corrosion. Check to be sure magnet levers operate freely. Clean and lubricate brake assemblies.
	Weak or Broken springs	Check for weak or broken springs, replace if necessary.
NOISY BRAKES	Lining excessively worn	Check and replace if necessary.
	Weak or broken springs	Check for weak or broken springs, replace if necessary.
	Range improperly located, bent backing plates	Check and repair if necessary
	Contaminated lining	Check and replace badly contaminated linings.
	Improper bearing adjustment	Check and adjust bearings. Check for worn or damaged bearings, replace if necessary.
	Brakes incorrectly adjusted	Check brake adjustment.

Dial before you dig

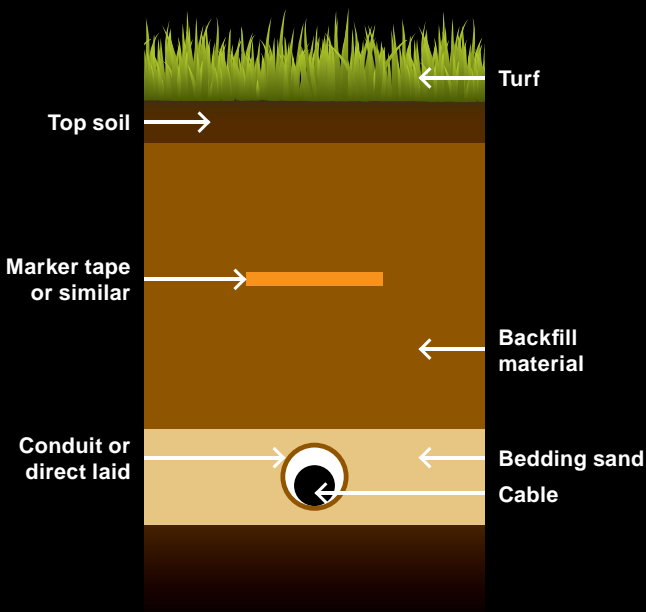

Working near underground power cables

For more information call **13 12 53**

or visit energex.com.au/safety

 Follow us on twitter.com/energex

 Like us on facebook.com/energex



positive energy

Working near underground power cables

Have you checked for underground services?

In the planning stages prior to performing any earthmoving or excavation work, make sure you are aware of the location of underground power cables. Remember to follow the four Ps:

- **Plan** – Contact Dial Before You Dig (www.1100.com.au) to request a plan for your underground assets.
- **Pothole** – Potholing may be required to determine the exact location of the services.
- **Protect** – Underground assets may require mechanical protection.
- **Proceed** – Only after you are confident that you have put in place all required controls is it safe to proceed.

Colour	Underground Assets
Orange	Electricity
Yellow	Gas
Green	Water
White	Communications
Red	Fire Services
Cream	Sewerage
Purple	Reclaimed Water
Silver/Grey	Steam
Brown	Oils, Flammable Liquids
Light Blue	Air
Black	Other Liquids



positive energy