

Operator's Manual



McELROY

www.mcelroy.com



Pit Bull[®]

FUSION MACHINES



WARNING

Cancer and Reproductive Harm -
www.P65warnings.ca.gov

8165361

This product and other products could be protected by patents or have patents pending. All the latest patent information is available at patent.mcelroy.com

Introduction

Thank you for purchasing this McElroy product.

The McElroy Pit Bull[®] close quarter hydraulically operated fusion machine is designed to be used in-ditch or above ground and is easily moved by two operators.

The Pit Bull 28 model fuses 2" IPS (63mm) minimum to 8" DIPS (225mm) maximum pipe.

The Pit Bull 250 model fuses 2" IPS (63mm) minimum to 250mm maximum pipe.

The Pit Bull 412 model fuses 4" IPS (110mm) minimum to 12" DIPS (340mm) maximum pipe.

The Pit Bull 618 model fuses 6" IPS (180mm) minimum to 18" OD (450mm) maximum pipe.

The Pit Bull 500 model fuses 6" IPS (180mm) minimum to 20" OD (500mm) maximum pipe.

Each fusion machine consists of:

- 1) Heater
- 2) Facer and Facer Stand
- 3) Carriage Assembly

Required and sold separately are:

- 1) Hydraulic Power Unit - EP1500P (Pit Bull[®] HPU)
- 2) Hydraulic Hoses

With reasonable care and maintenance, this machine will give years of satisfactory service.

Before operating this machine, please read this manual thoroughly, and keep a copy with the machine for future reference. This manual is to be considered part of your machine. A replacement manual can be obtained online at: www.mcelroy.com

TX02264-10-16-19



PH02978-3-18-05

McElroy University

For more than 30 years, McElroy has been the only pipe fusion machine manufacturer to continuously offer advanced training. Course offerings are meant to enhance your efficiency, productivity and safety in the proper use of McElroy machines. McElroy University classes are structured so that the skills learned and the machines used in each class closely match the machines found on pipelining jobsites. We offer training at our facility or yours. Our uniquely qualified McElroy University course instructors offer years of industry experience.

Tuition for each course includes lunches, course materials and a certificate of completion. Online registration, as well as up-to-date course offerings and dates, is available at www.mcelroy.com/university

This manual is intended as a guide only and does not take the place of proper training by qualified instructors. The information in this manual is not all inclusive and can not encompass all possible situations that can be encountered during various operations.

TX04659-03-24-14



MU2-03-13-14

Warranty

LIMITED WARRANTY

McElroy Manufacturing, Inc. (McElroy) warrants all products manufactured, sold and repaired by it to be free from defects in materials and workmanship, its obligation under this warranty being limited to repairing or replacing at its factory and new products, within **5 years** after shipment, with the exception of purchased items (such as electronic devices, pumps, switches, etc.), in which case that manufacturer's warranty applies. Warranty applies when returned freight is prepaid and which, upon examination, shall disclose to have been defective. This warranty does not apply to any product or component which has been repaired or altered by anyone other than McElroy or has become damaged due to misuse, negligence or casualty, or has not been operated or maintained according to McElroy's printed instructions and warnings. This warranty is expressly in lieu of all other warranties expressed or implied. The remedies of the Buyer are the exclusive and sole remedies available and Buyer shall not be entitled to receive any incidental or consequential damages. Buyer waives the benefit of any rule that disclaimer of warranty shall be construed against McElroy and agrees that such disclaimers herein shall be construed liberally in favor of McElroy.

RETURN OF GOODS

Buyer agrees not to return goods for any reason except upon the written consent of McElroy obtained in advance of such return, which consent, if given, shall specify the terms and conditions and charges upon which any such return may be made. Materials returned to McElroy, for warranty work, repair, etc., **must have a Return Material Authorization (RMA) number**, and be so noted on the package at time of shipment. For assistance, inquiry shall be directed to:

McElroy Manufacturing, Inc.
P.O. Box 580550
833 North Fulton Street Tulsa, Oklahoma 74158-0550
PHONE: (918) 836-8611, FAX: (918) 831-9285.
EMAIL: fusion@mcelroy.com

Note: Certain repairs, warranty work, and inquiries may be directed, at McElroy's discretion, to an authorized service center or distributor.

DISCLAIMER OF LIABILITY

McElroy accepts no responsibility of liability for fusion joints. Operation and maintenance of the product is the responsibility of others. We recommend qualified joining procedures be followed when using McElroy fusion equipment.

McElroy makes no other warranty of any kind whatever, express or implied; and all implied warranties of merchantability and fitness for a particular purpose which exceed the aforesaid obligation are hereby disclaimed by McElroy.

PRODUCT IMPROVEMENT

McElroy reserves the right to make any changes in or improvements on its products without incurring any liability or obligation to update or change previously sold machines and/or the accessories thereto.

INFORMATION DISCLOSED

No information of knowledge heretofore or hereafter disclosed to McElroy in the performance of or in connection with the terms hereof, shall be deemed to be confidential or proprietary, unless otherwise expressly agreed to in writing by McElroy and any such information or knowledge shall be free from restrictions, other than a claim for patent infringement, is part of the consideration hereof.

PROPRIETARY RIGHTS

All proprietary rights pertaining to the equipment or the components of the equipment to be delivered by McElroy hereunder, and all patent rights therein, arising prior to, or in the course of, or as a result of the design or fabrication of the said product, are exclusively the property of McElroy.

LAW APPLICABLE

All sales shall be governed by the Uniform Commercial Code of Oklahoma, U.S.A.

Register your product online to activate your warranty: www.McElroy.com/fusion

(Copy information listed on the machine nameplate here for your records).

Model No. _____

Serial No. _____

Date Received _____

Distributor _____

Table of Contents

Equipment Safety

Safety Alerts	1-1
Read and Understand	1-1
General Safety	1-2
Wear Safety Equipment	1-2
Heater is Not Explosion Proof.	1-2
Electric Motors are Not Explosion Proof.	1-3
Pipe Handling Safety	1-3
Units with Hydraulics	1-4
Electrical Safety.	1-4
Crush Points	1-5
Facer Blades are Sharp	1-5
Heater is Hot	1-5
Fusion Procedures	1-5

Overview

Theory of Heat Fusion	2-1
Carriage Assembly	2-2
Hydraulic Fluid Reservoir	2-2
Filter and Filler Cap	2-2
Motor and Pump	2-3
Relief Valve	2-3
Hydraulic Cylinders	2-4
Hydraulic Manifold Block.	2-4
Facer	2-5
Heater	2-5
Insulated Heater Stand	2-6
Electrical Box.	2-6

COPYRIGHT © 2019, 2017, 2015, 2014, 2013, 2012, 2008

McELROY MANUFACTURING, INC.

Tulsa, Oklahoma

All rights reserved

All product names or trademarks are property of their respective owners.

All information, illustrations, and specifications in this manual are based on the latest information available at the time of publication. The right is reserved to make changes at any time without notice.

Table of Contents

Operation

Read Before Operating	3-1
Setup	3-1
Check Hydraulic Fluid Level	3-1
Connecting Machine to Power	3-2
Pump Motor.	3-2
Prepare Heater	3-3
Install Clamping Inserts.	3-3
Outrigger.	3-4
Loading Pipe Into Machine	3-4
Positioning Pipe In Machine	3-5
Begin Facing	3-5
After Facing.	3-6
Determine Drag Pressure	3-6
Set Fusion Pressure	3-7
Check for Slippage.	3-7
Check Alignment.	3-7
Position Carriage for Heater Insertion	3-8
Check Heater Temperature.	3-8
Inserting Heater.	3-8
Heat Pipe	3-9
Fusing the Pipe	3-9
Opening Movable Jaws.	3-10
Opening Fixed Jaws.	3-10
Install Next Piece of Pipe	3-10

Special Operation - In Ditch

Remove 3-Jaw Assembly From the Carriage	4-1
Remove Facer From Pit Bull 28 and 250	4-2
Remove Facer From Pit Bull 412 and 618	4-3
Manual Facer Operation	4-4
Removing Top Jaws.	4-5
Lower 3-Jaw or 4-Jaw Carriage into Ditch	4-5
Clamp Carriage Assembly to Pipe	4-6
Attach Hydraulic Hoses	4-7
Make Fusion Joint.	4-7
Remove Carriage Assembly from Ditch.	4-7
Reassemble Carriage and Facer	4-7

Table of Contents

Special Operations - Saddle Fusion Procedure

Saddle Fusion Procedure for Pit Bull 28CU	5-1
Install Heater Adapters	5-1
Assure Saddle Will Fit	5-1
Install Clamping Inserts	5-2
Attach Carriage Assembly to Main	5-2
Set Hydraulic Pressure	5-2
Clean Surfaces	5-3
Clamp Fitting	5-3
Test for Slippage	5-3
Prepare Heater	5-4
Heat Pipe and Fitting	5-4
Remove Heater	5-5
Fuse Fitting to Pipe	5-5
Allow Joint to Cool	5-5

Special Operations - Lifting

Lifting Safety	6-1
----------------------	-----

Maintenance

Preventative Maintenance	7-1
Washing the Machine	7-1
Check Hydraulic Fluid	7-1
Change Hydraulic Fluid and Filter	7-1
Check Gauge	7-2
Clean Jaws and Inserts	7-2
Clean Thrust Bearings	7-2
Clean Eyebolt Threads	7-2
Fasteners Must Be Tight	7-3
Facer	7-3
Facer Blades	7-3
Clean Heater Surfaces	7-3
Bleeding Air From Hydraulic System	7-4
Installing Butt Fusion Heater Plates	7-4
Adjusting Heater Temperature	7-5
Heater Indicator Light	7-5

Maintenance Checklist

Fusion Machine Checklist	8-1
--------------------------------	-----

Determining Fusion Pressure

Determining Fusion Pressure	9-1
Determining Fusion Pressure - Sidewall	9-2

Hydraulic Fluid

Hydraulic Fluid	10-1
-----------------------	------

Specifications

Fusion Machine Specifications	11-1
Generator Sizing Form	11-3

Fusion Equipment Safety

Safety Alerts

This hazard alert sign  appears in this manual. When you see this sign, carefully read what it says. **YOUR SAFETY IS AT STAKE.**

You will see the hazard alert sign with these words: **DANGER**, **WARNING**, and **CAUTION**.

 **DANGER** Indicates an imminently hazardous situation which, if not avoided, will result in death or serious injury.

 **WARNING** Indicates a potentially hazardous situation which, if not avoided, could result in death or serious injury.

 **CAUTION** Indicates a hazardous situation which, if not avoided, may result in minor or moderate injury.

In this manual you should look for two other words: **NOTICE** and **IMPORTANT**.

NOTICE: can keep you from doing something that might damage the machine or someone's property. It may also be used to alert against unsafe practices.

IMPORTANT: can help you do a better job or make your job easier in some way.



WR00051-11-30-92

TX00030-12-1-92

Read and Understand

Do not operate this equipment until you have carefully read, and understand all the sections of this manual, and all other equipment manuals that will be used with it.

Your safety and the safety of others depends upon care and judgment in the operation of this equipment.

Follow all applicable federal, state, local, and industry specific regulations.

McElroy Manufacturing, Inc. cannot anticipate every possible circumstance that might involve a potential hazard. The warnings in this manual and on the machine are therefore not all inclusive. You must satisfy yourself that a procedure, tool, work method, or operating technique is safe for you and others. You should also ensure that the machine will not be damaged or made unsafe by the method of operation or maintenance you choose.



WR00052-12-1-92

TX02946-4-15-09

Fusion Equipment Safety

General Safety

Safety is important. Report anything unusual that you notice during set up or operation.

LISTEN for thumps, bumps, rattles, squeals, air leaks, or unusual sounds.

SMELL odors like burning insulation, hot metal, burning rubber, hot oil, or natural gas.

FEEL any changes in the way the equipment operates.

SEE problems with wiring and cables, hydraulic connections, or other equipment.

REPORT anything you see, feel, smell, or hear that is different from what you expect, or that you think may be unsafe.



TX0114--4-22-93

SAFE1ST-12-22-92

Wear Safety Equipment

Wear a hard hat, safety shoes, safety glasses, and other applicable personal protective equipment.

Remove jewelry and rings, do not wear loose-fitting clothing, and tie back long hair that could catch on controls or moving machinery.



TX00032-04-18-16

WR00053-12-2-92

Heater Is Not Explosion Proof

⚠ DANGER This heater is not explosion proof. Operation of heater in an explosive atmosphere without necessary safety precautions will result in serious injury or death.

If operating in an explosive atmosphere, the heater should be brought up to temperature in a safe environment, then **unplugged before entering** the explosive atmosphere for fusion.



TX00100-04-28-14

WR00034-11-30-92

Fusion Equipment Safety

Electric Motors are Not Explosion Proof



Electric motors are not explosion proof. Operation of these components in an explosive atmosphere without necessary safety precautions will result in serious injury or death.

When operating in an explosive atmosphere, keep pump motor and chassis in a safe area by using hydraulic extension hoses.



WR00080-4-12-93

TX00424-04-28-14

Pipe Handling Safety



Do not position yourself or any other personnel under supported or raised pipe. Pipe is heavy and could fall unexpectedly.



Pipe that is bent can store a great amount of energy. Do not bend and force the pipe into the machine. A bent pipe with stored energy can generate tremendous force when that energy is released.

It is recommended that the pipe is always held securely by either being clamped in the fusion machine jaws or properly attached to a lifting device.

NOTICE: Do not leave machine unattended to unauthorized personnel. Do not allow unauthorized personnel to operate the machine.

Keep persons that are not involved in handling pipe away from pipe handling operations. Keep away from the pipe when the pipe and handling equipment are in motion. When in motion, all persons involved in handling pipe should be able to see all other persons at all times. If any handling person is not in sight, immediately stop moving equipment and pipe and locate that person. Do not continue until all persons are accounted for and in sight.

Never push, roll, dump or drop pipe lengths, bundles or coils off the delivery truck, off handling equipment, or into a trench. Always use appropriate equipment to lift, move, and lower the pipe.

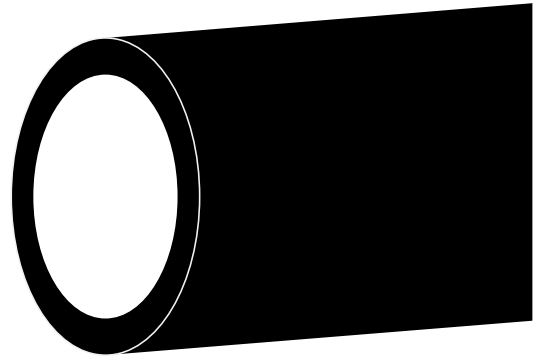

WR00097-4-17-13

TX04882-04-18-16

Fusion Equipment Safety

Units With Hydraulics

It is important to remember that a sudden hydraulic oil leak can cause serious injury, or even be fatal if the pressure is high enough.

⚠ WARNING Escaping fluid under pressure can penetrate the skin causing serious injury. Keep hands and body away from pinholes which eject fluid under pressure. Use a piece of cardboard or paper to search for leaks. If any fluid is injected into the skin, it must be immediately removed by a doctor familiar with this type of injury.

⚠ WARNING Unwanted movement of the machine could result in serious injury or damage to machine. Unwanted movement of the machine may take place if switches do not match machine state when the machine power is turned on.

NOTICE: Wear safety glasses, and keep face clear of area when bleeding air from hydraulic system to avoid spraying oil into eyes.



WR00078-4-B-93

TX03007-10-12-10

Electrical Safety

⚠ WARNING Always ensure equipment is properly grounded. It is important to remember that you are working in a wet environment with electrical devices. Proper ground connections help to minimize the chances of an electric shock.

Frequently inspect electrical cords and unit for damage. Have damaged components replaced and service performed by a qualified electrician.

NOTICE: Always connect units to the proper power source as listed on the unit, or in the owner's manual.

NOTICE: Disconnect the machine from the power source before attempting any maintenance or adjustment.

⚠ WARNING Disconnect the machine from the power source before attempting to service the control panel. Failure to disconnect the power could result in serious injury or death due to electric shock. Refer service to a qualified technician.



WR00055-4-7-93

WR00025-11-30-92

TX03003-3-30-11

Fusion Equipment Safety

Crush Points



WARNING Hydraulically operated equipment operates under high pressure and generates extremely high forces. Anything inadvertently caught in the machine will be crushed. Keep fingers, feet, arms, legs, and head out of the machine while operated. Always ensure machine power is off before entering the machine for any reason.

TX03004-04-18-16



WR00012-12-4-92

Facer Blades Are Sharp



WARNING Facer blades are sharp and can cut. Never attempt to remove shavings while the facer is running, or is in the facing position between the jaws. Use care when operating the facer, and when handling the unit.

NOTICE: Turn machine off, disconnect machine power, and remove the facer blades before attempting any maintenance or adjustment.

NOTICE: Never extend the facer blades beyond the inner or outer circumference of the facer.

TX02378-04-18-16

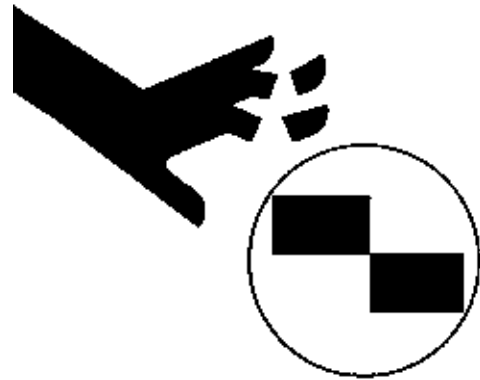

WR00073-4-6-93

Heater Is Hot



The heater is hot and will burn clothing and skin. Keep the heater in its insulated heater frame or stand when not in use, and use care when heating the pipe.

NOTICE: Use only a clean dry lint free non-synthetic cloth to clean the heater butt plates.

TX04244-04-18-16



WR00030-2-10-93

Fusion Procedures

Obtain a copy of the pipe manufacturer's procedures or appropriate joining standard for the pipe being fused. Follow the procedure carefully, and adhere to all specified parameters.

NOTICE: Failure to follow pipe manufacturer's procedure could result in a bad joint. Always follow pipe manufacturer's procedures.

TX04469-10-24-12

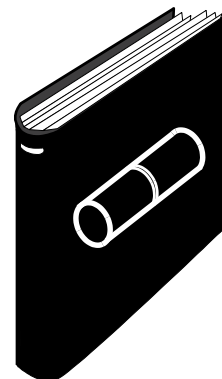

WR00079-2-7-96

Overview

Theory of Heat Fusion

The principle of heat fusion is to heat two pipe surfaces to a designated temperature, and then fuse them together by application of force. This develops pressure which causes flow of the melted materials, which causes mixing and thus fusion. When the thermoplastic material is heated, the molecular structure is transformed into an amorphous condition. When fusion pressure is applied, the molecules from each thermoplastic part mix. As the joint cools, the molecules return to their form, the original interfaces are gone, and the fitting and pipe have become one monolithic unit. A strong, fully leak tight connection is the result.

The principal operations include:

- Clamping** The pipe pieces are held axially and radially to allow all subsequent operations to take place.
- Facing** The pipe ends are faced to establish clean, parallel mating surfaces perpendicular to the centerline of the pipes.
- Aligning** The pipe ends are aligned with each other to minimize mismatch of the pipe walls.
- Heating** A melt pattern that penetrates into the pipe is formed around both pipe ends.
- Fusing** The melt patterns are joined with a specified force, which is constant around the pipe interfacial area.
- Cooling** The fusion joint is held immobile with a specified force until adequately cooled.
- Inspecting** Visually examine the entire circumference of the joint for compliance with the standard or fusion procedure used.

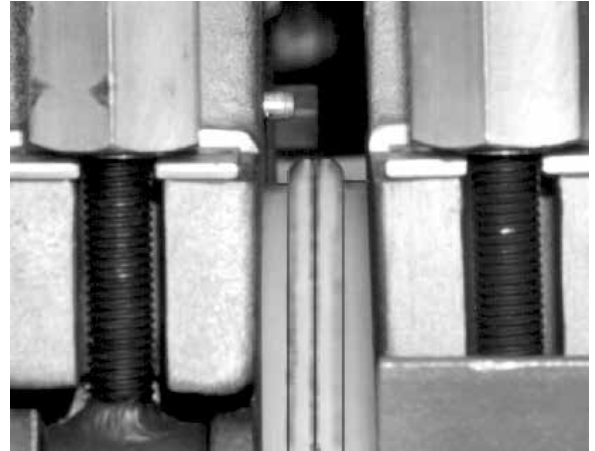

PH00363B-9-12-94

Overview

Carriage Assembly

The carriage assembly consists of two fixed jaws and two hydraulically operated movable jaws.



PH02649-3-8-04

TX01542-5-6-98

Hydraulic Fluid Reservoir

The reservoir is incorporated in the EP1500P (Pit Bull HPU)

The fluid level should remain visible between the top and bottom of the sight gauge in the side of the reservoir.

Never allow dirt or other foreign matter to enter the open tank.

Refer to the "Hydraulic Fluids" section of this manual for hydraulic fluid recommendations.



PH02974-3-18-05

TX04380-10-16-19

Filter and Filler Cap

This machine is equipped with a 10 Micron filter (A) on the return side of the hydraulic system.

Change filter when the indicator gauge (B) reads between 20 psi and 25 psi (yellow range).

The reservoir is filled by removing the cap (A) and the filter.

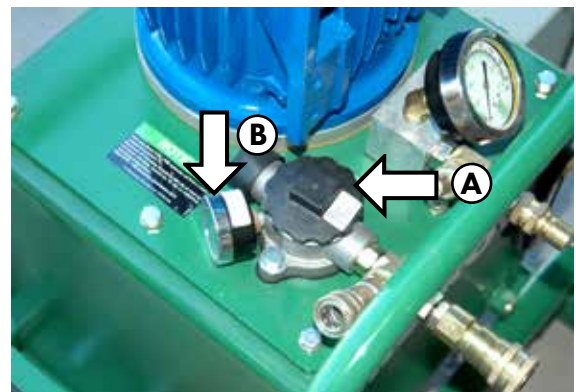

PH02975-3-18-05

TX02267-3-8-04

Overview

Motor and Pump

The pump is powered by a TEFC motor mounted inside the reservoir.
The pump is pressure compensated with an external pressure adjustment.



PH02976-3-18-05

TX02266-1-20-12

Relief Valve

The overall system pressure is set with the relief valve mounted on top of the reservoir. This pressure is set at 1500 psi (10,340 kPa) and is sufficient for most pipe.

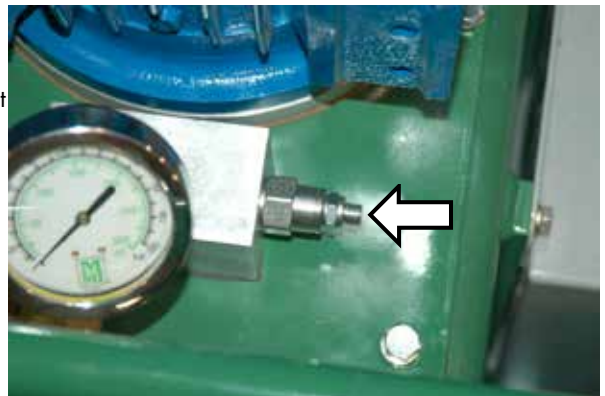

PH02977-3-18-05

TX02268-3-8-04

Overview

Hydraulic Cylinders

HIGH FORCE hydraulic carriage cylinders are painted green. High force cylinders are used when higher interfacial pressures are required, when handling heavy wall pipe, or when large drag factors need to be overcome.

MEDIUM FORCE cylinders are painted orange and have approximately half the total effective piston area as High Force cylinders. The cylinders move faster and are normally used for medium density pipe and when lower interfacial pressures are used.

LOW FORCE cylinders are painted yellow. These cylinders should be selected when fusing pipe with a very low interfacial pressure (22 psi).

IMPORTANT: Use the correct total effective piston area to calculate the gauge pressure.



PH02682-3-8-04

TX01270-3-30-11

Hydraulic Manifold Block

Mounted on this block are a carriage directional control valve, a pressure reducing selector valve, three pressure reducing valves, and a 1500 psi gauge.

- A) The carriage control valve, mounted on the top of the manifold, determines whether the carriage is moving left, right, or is in neutral.
- B) A 1500 psi gauge is mounted on top of the manifold.
- C) The selector valve, mounted on the front of the manifold, selects a reduced pressure from one of the pressure reducing valves.

Each pressure reducing valve is labeled with a different function:

- D) The top valve adjusts facing pressure to a maximum of 400 psi.
- E) The middle valve adjusts heating pressure to a maximum of 400 psi.
- F) The bottom valve adjusts fusion pressure to a maximum of 1500 psi.
- G) DataLogger port



PH00797-4-10-96

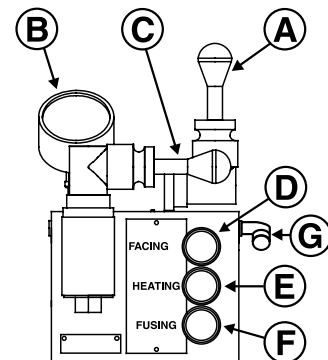

CD00138H-1-12-11

TX00357-1-12-11

Overview

Facer

The facer is a McElroy rotating planer-block design. The block rotates on a ball bearing and is chain driven by a hydraulic motor.

When fusing 4" and 6" diameter pipe on the 412 or 618 move the facer blades to the inboard position.

NOTICE: Never extend the blade beyond the inner or outer circumference of the facer.

TX02361-12-15-04



PH02663-3-8-04

Heater

⚠ DANGER Heater is not explosion proof. Operation of heater in an explosive atmosphere without necessary safety precautions will result in serious injury or death.

If operating in an explosive atmosphere, heater should be brought up to temperature in a safe environment, then **unplugged before entering** the explosive atmosphere for fusion.

The heater has a green indicator light which will flash on and off. This indicates that the controller is operating normally. If the green indicator is not flashing then the controller may not be operating properly. If this occurs, disconnect power and have the heater repaired by an McElroy Authorized Service Center.

The heater temperature is controlled by a microprocessor. It has a red indicator light on the handle at the bottom of the temperature scale. When the heater is plugged in and preheating the light glows steadily until the set temperature is reached. The light then goes off and on slowly as the heater maintains temperature.

The heater body is not coated. Coated butt fusion heater plates are available for all butt fusion applications.

NOTICE: The heater should never be used without butt fusion heater plates installed.

To prevent a build-up of plastic pipe residue from accumulating on the heater plates (loss of surface temperature and pipe sticking may result), the heater plates should be cleaned with a non-synthetic cloth before every fusion joint.

TX02309-04-28-14



PH03874-4-15-09



PH02313-3-8-04



PH02333-3-8-04

Overview

Insulated Heater Stand

The heater should always be stored in the insulated heater stand or blanket for protection of the operator and to minimize heat loss and risk of mechanical damage.



PH03874-4-15-09

TX00363-9-15-94

Electrical Box

The start and stop push buttons are located on the front of the electrical box.



PH02658-3-8-04

Located below the start and stop push buttons is an hour meter that indicates how many hours the unit has been in operation.



PH02654-3-8-04

TX02289-3-8-04

Operation

Read Before Operating

Before operating this machine, please read this manual thoroughly, and keep a copy with the machine for future reference.

Return manual to the protective storage box when not in use. This manual is to be considered part of your machine.



TX00401-9-15-94

STOP-9-22-95

Setup

There are four hydraulic hoses that connect the facer and the carriage to the hydraulic power unit. The unit must be off to connect or disconnect the hoses.

Connect the 3/8" quick disconnects on the hydraulic power unit to the facer and the 1/4" quick disconnects to the carriage.



TX02270-3-8-04

PH01908-3-8-04

Check Hydraulic Fluid Level

Check fluid level in sight gauge on reservoir and add fluid if necessary.

Refer to the "Hydraulic Fluids" section of this manual for hydraulic fluid recommendations.

Do not overfill reservoir. The fluid will expand as it heats up.

Never allow dirt, water, or other foreign matter to enter the tank.

Use only clean fluid from an unopened container.



TX04377-05-06-14

PH02974-3-18-05

Operation

Connecting Machine to Power

DANGER

All electrical equipment and power sources must be located in a non-explosive atmosphere. Failure to do so will result in serious injury or death.

Plug machine's electrical cord into a proper power source.

The reverse phase relay ensures correct rotation of the pump motor so damage to the hydraulic system does not occur.

If unit fails to start, check to see if the light on the reverse phase relay inside the electrical box is on, indicating correct phasing. Do not touch components inside the electrical box when visually inspecting the reverse phase relay.

If the reverse phase relay light is not on, disconnect the power source and switch any two incoming power leads and try again. If the unit still doesn't start and the light is on, call qualified service personnel for assistance.

WARNING

Disconnect the machine from the power source before attempting to service the electrical box. Failure to disconnect the power could result in serious injury or death due to electric shock. Refer service to a qualified technician.



PH02686-3-8-04

TX04381-05-06-14

Pump Motor

DANGER

Pump motor is not explosion proof. Operation of pump motor in an explosive atmosphere without necessary safety precautions will result in serious injury or death.

Locate pump motor in a safe environment. Turn on hydraulic pump motor and note pressure at the gauge.

IMPORTANT: Unplug heater when starting pump motor. This will reduce the load on the power supply.



WR00080-4-12-93



PH02976-3-18-05

TX04382-05-06-14

Operation

Prepare Heater

⚠ DANGER Heater is not explosion proof. Operation of heater in an explosive atmosphere without necessary safety precautions will result in serious injury or death.

If operating in an explosive atmosphere, heater should be brought up to temperature in a safe environment, then unplugged before entering the explosive atmosphere for fusion.

Install butt fusion heater plates while heater is cool.

NOTICE: The heater should never be used without butt fusion heater plates installed. Refer to the "Maintenance" section of this manual for installation procedure.

Place heater in insulated heater stand.

Plug heater into a proper power source.

Refer to the "Maintenance" section of this manual for instructions how to adjust heater temperature.

Allow heater to warm-up to operating temperature.



PH03874-4-15-09



PH02685-3-8-04

TX04383-05-06-14

Install Clamping Inserts

Select and install appropriate clamping inserts for the pipe that is being fused.

Clamping inserts are required for all sizes except sizes that match the size of the jaw without inserts.



PH00304-9-24-93

TX02956-4-15-09

Operation

Outrigger

Machines with pivoting facers are equipped with an outrigger. The outrigger is an arm that is retractable and adds support to the carriage assembly when opening the jaws and pivoting the facer away from the carriage.

To extend or retract the outrigger, press the locking button near the base of the outrigger and push or pull the arm until the button snaps to the locked position.

NOTICE: Never use the outrigger to lift or move the carriage.



PH02698-04-29-04



PH02699-04-29-04

TX02304-04-04-05

Loading Pipe Into Machine

Clean the inside and outside of pipe ends that are to be fused.

Open the upper jaws and insert pipe in each pair of jaws with applicable inserts installed. Let the ends of the pipe protrude about 1" past the face of the jaws.



PH02660-3-8-04

TX0371-9-15-94

Operation

Positioning Pipe In Machine

Swing the facer into place. With the carriage control valve lever, move the carriage toward the fixed jaws, while watching the gap at each end of the facer rest buttons. When the pipe is in contact with the facer, this gap indicates the amount of material that will be trimmed from the pipe end. Assure sufficient material will be removed for a complete face off. Tighten the clamp knobs on the outside jaws. Hand tighten the inside clamp knobs.

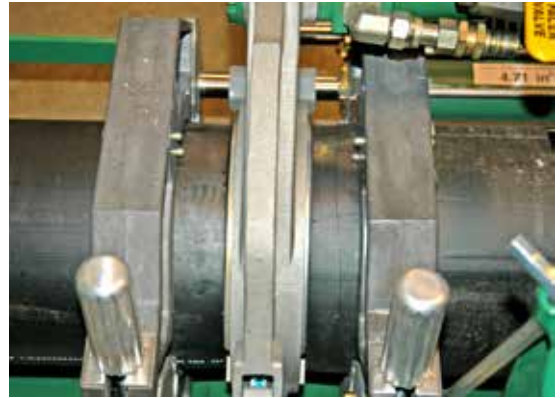

PH02661-3-8-04

TX00372-9-15-94

Begin Facing

Turn facer on by opening valve on top of the facer.

Move the selector valve on the hydraulic manifold block to the top (facing pressure) position.

The facing pressure should be set as low as possible while still facing pipe. Excessive facing pressure can damage the facer. It may be necessary to adjust the carriage pressure.



WARNING Facer blades are sharp and can cut. Never attempt to remove shavings while the facer is running, or is in the facing position between the jaws. Use care when operating the facer, and when handling the unit.

Activate the carriage control valve and move the carriage to the left to begin facing. Continue to face the pipe until the rest buttons on the jaws bottom out on the facer rest buttons.

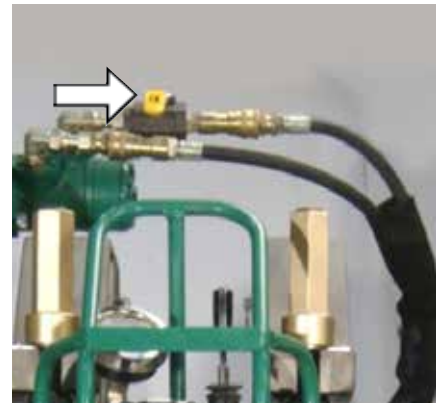

PH00361-9-12-94

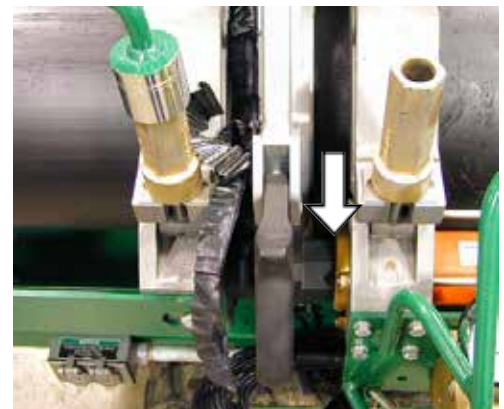

PH01901-11-15-00

TX04261-3-30-11

Operation

After Facing

Turn facer motor off. Move carriage all the way to the right. Center the facer in between the pipe ends to avoid dragging facer stops on the pipe ends. Swing facer to the out position. Clean shavings out of pipe ends and from between the jaws. Do not touch faced pipe ends.

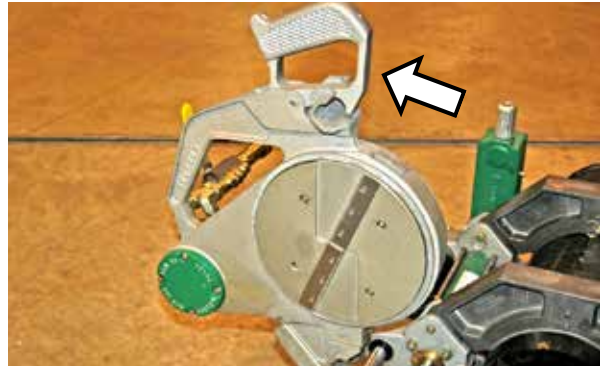

PH02663-3-8-04

TX04262-3-30-11

Determine Drag Pressure

Drag pressure should be determined using the following procedure:

Move the carriage so that the faced pipe ends are approximately 2" apart.

Shift the carriage control valve to the middle (neutral) position.

Select the heating mode, and adjust the middle pressure reducing valve to its lowest pressure by turning the valve counterclockwise.

Shift the carriage control valve to the left.

Gradually increase the pressure by turning the valve clockwise. Increase the pressure until the carriage moves.

Quickly reduce the heating pressure valve counterclockwise until the carriage is just barely moving.

Record this actual drag pressure.

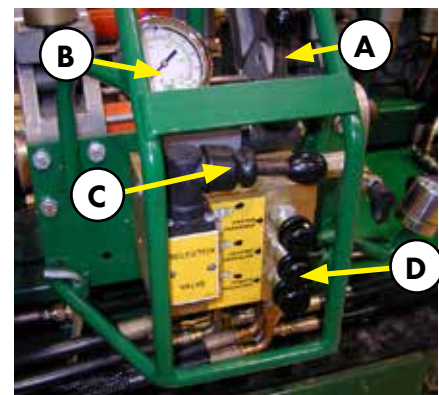

PH01924-11-15-00

- A - Carriage Control Valve
- B - Pressure Gauge
- C - Pressure Selector Valve
- D - Pressure Reducing Valves (3)

TX03023-8-19-09

Operation

Set Fusion Pressure

With the selector valve in the down position, the fusion pressure can be set.

The theoretical fusion pressure can be calculated using the enclosed fusion pressure calculator. Always add drag pressure to the theoretical fusion pressure.

Gauge (Fusion) Pressure = Theoretical Fusion Pressure + Drag Pressure



PH04004-8-25-09

TX03024-10-19-10

Check for Slippage

Bring the two sections of pipe together under fusion pressure to make sure they don't slip in the jaws.

If slippage occurs, return to **Loading Pipe into Machine**.

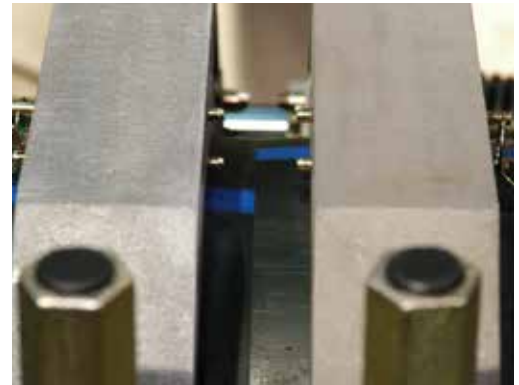

PH04464-1-31-11

TX00971-12-7-10

Check Alignment

Move carriage to the left at facing pressure, until pipe ends contact. Look across the top surface of pipe ends to check alignment. If there is a noticeable step across the joint, adjustments must be made.

WARNING Hydraulically operated equipment is operated under pressure. Anything caught in the machine will be crushed. Keep fingers, feet, arms, legs, and head out of the machine while operated.

If pipe is not lined up, tighten the high side jaw to bring into alignment.

IMPORTANT: Always tighten the side that is higher, never loosen the low side.

When the pipe is properly aligned, ensure all clamp knobs are tight.

NOTICE: When clamping, do not over-tighten the clamp knobs because machine damage can result. Check to see if there is space between the upper and lower jaws. If the two jaws are touching, do not continue to tighten.

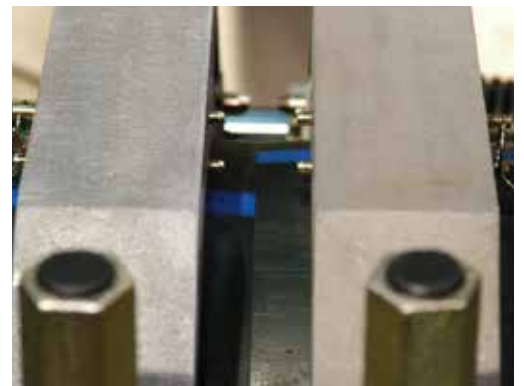

PH04464-1-31-11

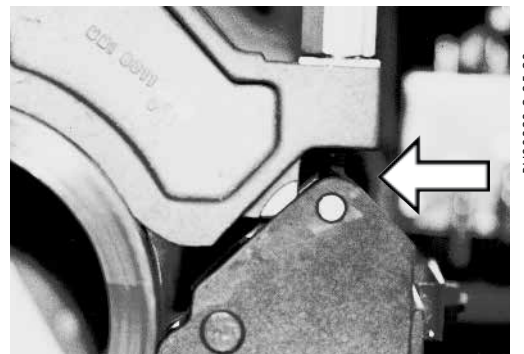

PH00323-9-25-93

TX04263-3-30-11

Operation

Position Carriage for Heater Insertion

Move carriage to the right to open a gap large enough to insert the heater.

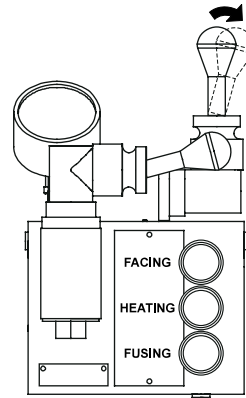

CD00138D-9-12-94

TX00374-9-15-94

Check Heater Temperature

NOTICE: Incorrect heating temperature can result in questionable fusion joints. Check heater plates periodically with a pyrometer and make necessary adjustments.

Check heater surface temperature.

Refer to the pipe manufacturer's recommendations or appropriate joining standard for proper heater temperature.



WR00077-4-16-93

TX04384-1-20-12

Inserting Heater

⚠ DANGER Heater is not explosion proof. Operation of heater in an explosive atmosphere without necessary safety precautions will result in serious injury or death.

If operating in an explosive atmosphere, heater should be brought up to temperature in a safe environment, then unplugged before entering the explosive atmosphere for fusion.

Use a clean nonsynthetic cloth to clean the butt fusion heater surfaces.

Verify heater temperature by noting the reading on the dial thermometer.

Insert heater between the pipe ends.



PH02333-7-08-02



PH01094-2-20-97

TX00377-04-16-14

Operation

Heat Pipe

Shift the selector valve (A) to the center position, and set the heating pressure (if required). If heating pressure is not required, set the pressure reducing valve (B) at its lowest setting, or the drag pressure, whichever is higher.

Shift the selector valve (A) to the fusion position and move the carriage control valve (C) to the left to bring pipe ends in contact with the heater. Move selector valve (A) to middle (heating mode) position. If heater pressure is not required by pipe manufacturer or joining standard, or opposing forces are not great enough to move the carriage away from the heater, shift the carriage control valve to neutral.

IMPORTANT: Always shift into the heating mode **before** returning carriage valve to neutral.

Follow the pipe manufacturer's suggested heating and soaking procedure or joining standard.

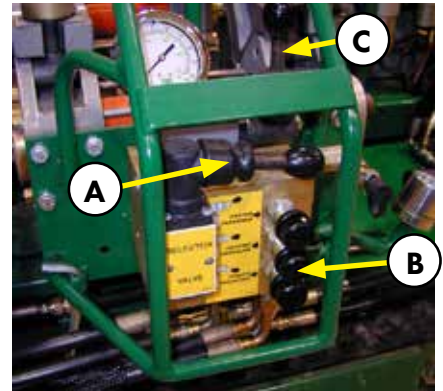

PH01924-11-15-00



PH04465-1-31-11

TX04264-3-30-11

Fusing the Pipe

NOTICE: Failure to follow the pipe manufacturer's heating time, pressure and cooling time may result in a bad joint.

After following the heating procedure, verify carriage control valve is in neutral and move selector valve down, to fusion position.

Move the carriage to the right just enough to remove the heater.

Quickly remove the heater.

Quickly inspect pipe ends for appropriate melt.

When heater is clear of the jaws, quickly move the carriage to the left and bring the pipe ends together using the pipe manufacturer's recommended pressure.

Allow joint to cool under pressure according to pipe manufacturer's recommendations or appropriate joining standard.

Visually examine the entire circumference of the joint for compliance with standards established by your company, customer, industry, federal, state, or local regulations.

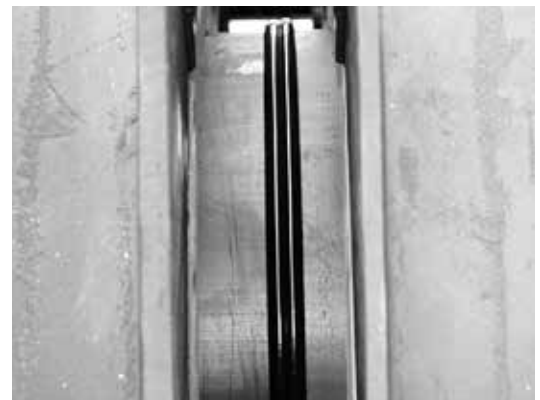

TX04265-1-20-12

Operation

Opening Movable Jaws

After the joint has cooled for the pipe manufacturer's recommended time, shift the carriage control valve to the neutral position.

Loosen all clamp knobs, and open the movable jaws.

Move the carriage to the right so that the facer is clear of and the right of the fixed jaws of the carriage.

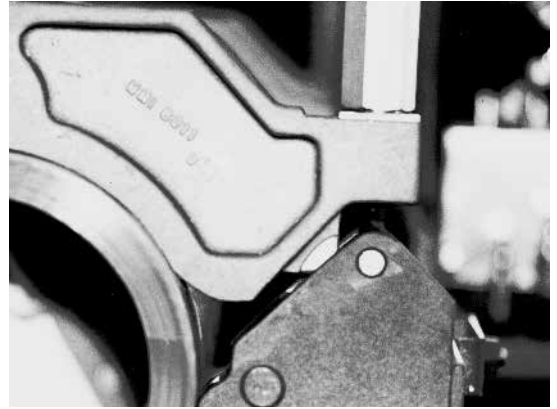

PH00323-9-25-93

TX04385-1-20-12

Opening Fixed Jaws

Open the fixed jaws.



PH02580-1-16-12

TX00381-9-16-94

Install Next Piece of Pipe

Insert a new piece of pipe in movable jaws and repeat all previous procedures.



PH02660-3-8-04

TX00384-10-12-95

Special Operations - In Ditch

Remove 3-Jaw Assembly from the Carriage

Remove braces from inner fixed jaw.



PH01939-11-15-00

Remove the four bolts holding the carriage assembly to the skid with the wrench provided.



PH01945-11-15-00

Attach lifting strap as shown and lift the carriage assembly.



PH01947-11-115-00



PH04467-2-3-11



PH02690-3-8-04

TX02329-10-25-04

Special Operations - In Ditch

Remove Facer From Pit Bull 28 and 250

Loosen facer locking bolts.



Lift facer out of the carriage and set on cardboard or wood blocks off of ground.

Remove rear guide rod bracket.



Attach rear guide rod bracket in the position shown.



TX02293-3-8-04

Special Operations - In Ditch

Remove Facer From Pit Bull 412 and 618

Remove rear guide rod bracket.



PH01933-11-15-00

Support the facer with a person or sling so it does not fall once the facer locking bolts are removed.

Remove facer locking bolts.



PH01907-11-15-00

Lift facer out of the carriage and set on cardboard or wood blocks off of ground.

Attach rear guide rod bracket in the position shown.



PH01936-11-15-00

TX01992-3-30-11

Special Operations - In Ditch

Manual Facer Operation

Lift as shown.



PH019388-11-15-00

Lock onto back guide rod, then latch on front guide rod.

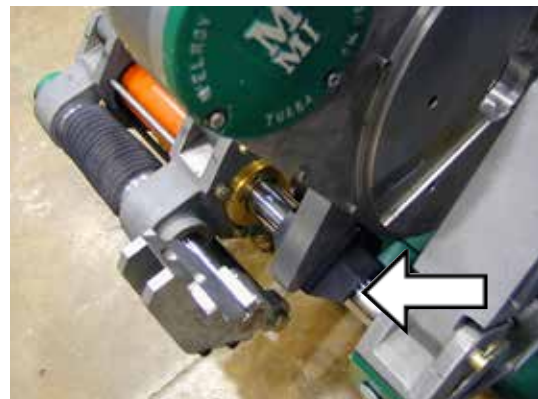

PH01946-11-15-00

Special Operations - In Ditch

Removing Top Jaws

If the carriage is going to be hand carried, or if the carriage needs to be hoisted and slid underneath the pipe, the top jaws need to be removed.

Loosen all clamp knobs. Take out the detent pins securing the top jaws and remove the jaws.

TX01479-2-26-98

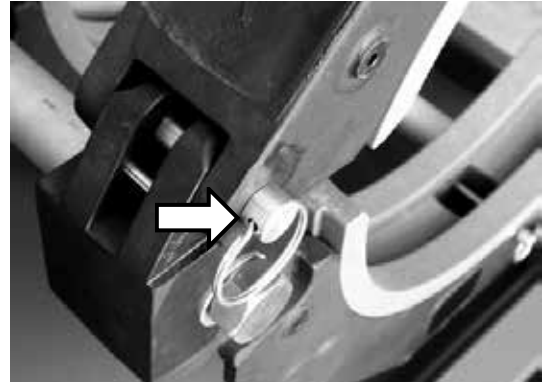

PH01305-3-12-98

Lower 3-Jaw or 4-Jaw Carriage into Ditch

Use all 4 jaws whenever possible. The three jaw unit should be used only when space is not available for the entire carriage, such as fusing onto a tee, an ell or doing saddle fusion.

4-Jaw

Attach lifting sling to the manifold bracket and the far side lift point on the fixed jaw brace.

Lift carriage assembly and lower into ditch.

3-Jaw

Attach lifting sling to the manifold bracket.

Lift carriage assembly and lower into ditch.

TX01864-3-30-11



PH04466-1-31-11



PH04467-2-3-11

Special Operations - In Ditch

Clamp Carriage Assembly to Pipe

Position carriage assembly on side of the pipe. Lift pipe and slide carriage assembly under pipe.

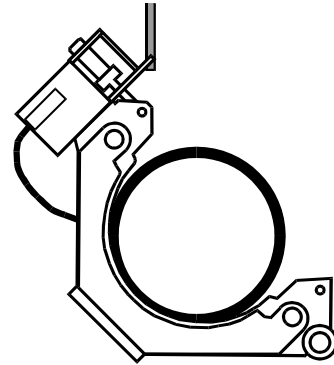

CD00193b-2-19-96

Rotate carriage assembly around to a normal upright position.



CD00194b-2-19-96

Attach the top jaws and loosely clamp around pipe.

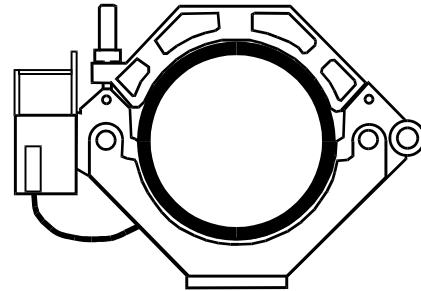

CD00195a-2-19-96

TX00879-2-19-96

Special Operations - In Ditch

Attach Hydraulic Hoses

There are four hydraulic hoses that connect the facer and the carriage to the hydraulic power unit. The unit must be off to connect or disconnect the hoses.

Connect the 3/8" quick disconnects on the hydraulic power unit to the facer and the 1/4" quick disconnects to the carriage.

TX02270-3-8-04



PH01908-11-15-00

Make Fusion Joint

Refer to the "Butt Fusion Procedure" for operating instructions.

After facing operation, remove the facer from ditch.

TX00450-9-16-94

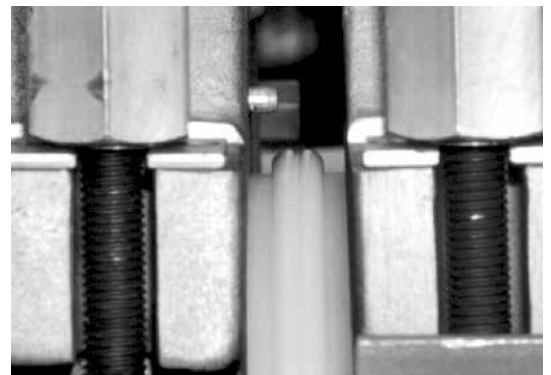

PH00363-9-12-94

Remove Carriage Assembly from Ditch

Loosen clamp knobs and remove top jaws.

Rotate carriage assembly from under the pipe.

IMPORTANT: Always rotate unit with valve system facing up to protect against damage.

Attach sling to lifting point(s).

Lift carriage assembly from ditch.

TX00451-9-16-94

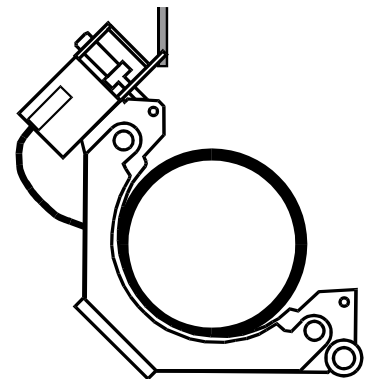

CD00193b-9-29-00

Reassemble Carriage and Facer

Lift facer into position and bolt to facer mount. Do not tighten. Pivot facer down and bring jaws inward against the facer to establish facer position. Open jaws away from facer and pivot facer out. Tighten the facer mounting bolts.

Replace top jaws.

TX02294-3-8-04



PH01907-11-15-00

Special Operations - Saddle Fusion Procedure

Saddle Fusion Procedure for Pit Bull 28CU

The combination unit fuses branch saddles up to 8" DIPS outlet and up to a 9-5/8" diameter base on any size main.

IMPORTANT: Optional chain extension kit are available for larger main sizes.

TX00454-3-30-11



PH00406-9-21-94

Install Heater Adapters



Heater is not explosion proof. Operation of heater in an explosive atmosphere without necessary safety precautions will result in serious injury or death.

If operating in an explosive atmosphere, heater should be brought up to temperature in a safe environment, then unplugged before entering the explosive atmosphere for fusion.

Select appropriate heater and sidewall fusion heater adapters. Clean heater surfaces and adapter surfaces. Attach the adapters to the heater when the heater is cool.

Place heater in insulated heater blanket.

Plug heater into a proper power source.

TX04386-05-06-14



PH00416-11-1-94



PH00418-11-1-94

Assure Saddle Will Fit

For branch saddles, a nipple long enough to extend through both movable jaws should be fused to the fitting using standard butt fusion procedures.



PH00423-11-1-94

TX00456-9-15-94

Special Operations - Saddle Fusion Procedure

Install Clamping Inserts

Select and install appropriate clamping inserts in the movable jaw(s).

TX00457-9-16-94



PH00304-9-23-93

Attach Carriage Assembly to Main

Place the machine on the main.

Place a line bolster on main opposite the carriage assembly if required.

Position the tailstock chains around the main and lock into the chain hooks.

Tighten the machine onto the main using the tailstock clamp knobs.

TX00458-9-16-94

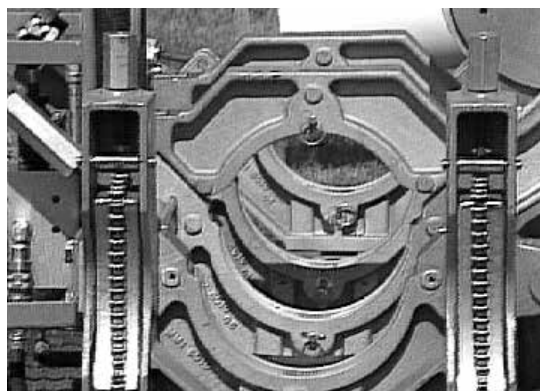

PH00387-9-21-94

Set Hydraulic Pressure

Check hydraulic pressure. Shift the selector valve to the center position to set the pressure for heat/soak. With the selector valve in the down position, the initial heat (bead-up) pressure can be set. With the selector valve in the top position, the fusion pressure can be set.

Consult the pipe manufacturer or appropriate joining standard for proper pressures.

TX04025-4-12-10

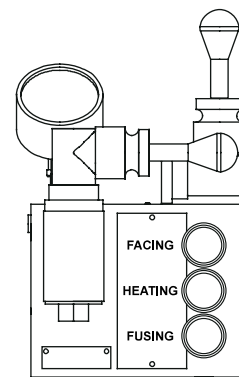

CD001388B-9-12-94

Special Operations - Saddle Fusion Procedure

Clean Surfaces

Clean the pipe in the area the fitting will come in contact.

Clean the base of the fitting.

Use a 50 or 60 grit utility cloth, scraping tool, or other procedure specified by the pipe manufacturer, fitting manufacturer, or applicable standard.

Clean and rough the main to expose fresh material.

Surfaces must be free of water and oil.

TX01879-3-30-11



PH00400-9-21-94

Clamp Fitting

Position the fitting, and bolster if required, loosely in the movable jaw(s).

Close the carriage to properly position the fitting on the main. Tighten the clamp knobs.

Be sure to allow enough travel for the melt pattern and fusion to occur (3/4" min.).

TX04027-4-12-10

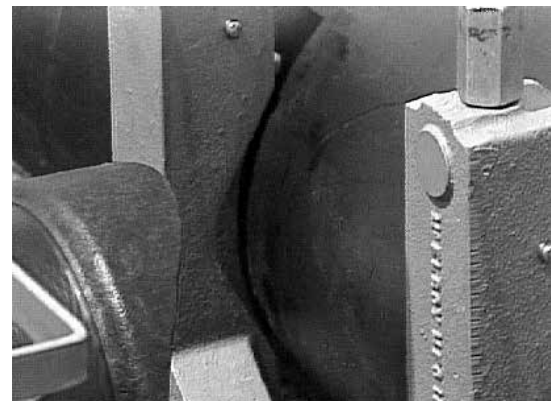

PH00399-9-21-94

Test for Slippage

Bring the fitting against the main under initial heat (bead-up) pressure to insure that no slippage or movement of the main or fitting occurs.

TX00462-3-30-11

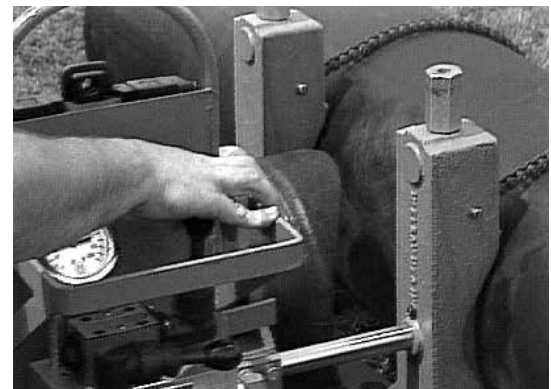

PH00390-9-21-94

Special Operations - Saddle Fusion Procedure

Prepare Heater

NOTICE: Incorrect heating temperature can result in questionable fusion joints. Check heater plates periodically with a pyrometer and make necessary adjustments.

Refer to the "Maintenance" section of this manual for instructions on how to adjust heater temperature.

Check heater surface temperature with a pyrometer.

Refer to the pipe manufacturer's recommendations or appropriate joining standard for proper heater temperature.

IMPORTANT: The dial thermometer on the heater indicates internal temperature which varies from the actual surface temperature.

The dial thermometer can be used as reference once the surface temperature has been verified and is never a substitute for actual surface temperature.



PH00417-11-1-94

TX04386-1-20-12

Heat Pipe and Fitting

Move selector valve to the bottom position.

Move the fitting against the Flexible Heat Shield under bead-up pressure, and observe melt bead formation on the main all around the heater faces. When a melt bead is first visible on the main all around the heating tool faces, in a quick continuous motion, open the carriage slightly and remove the Flexible Heat Shield.

Move the fitting against the heater face and start the heat time. When a melt bead is first visible all around the fitting base (usually about 3 to 5 seconds) immediately move the selector valve to the middle position to reduce pressure to the heat soak pressure (usually drag). Wait for the pressure to drop to drag pressure then shift the control valve to neutral. Maintain the heat soak pressure according to the pipe fitting manufacturer's recommendations or appropriate joining standard.

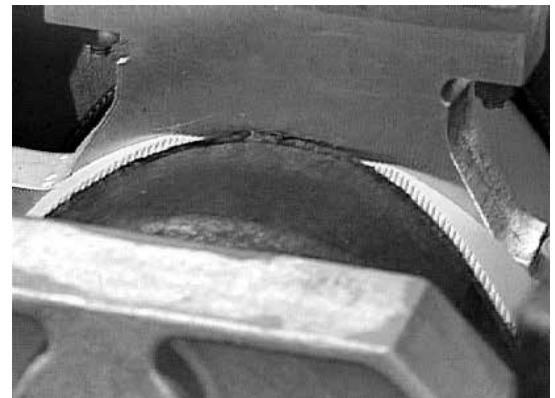

PH00402-9-21-94

TX04042-4-12-10

Special Operations - Saddle Fusion Procedure

Remove Heater

Shift the carriage control valve to neutral and move the selector valve to the top position. Open the carriage just enough to remove the heater.

Remove the heater.

Quickly check for a complete and even melt pattern on the pipe and fitting.

TX04029-4-12-10

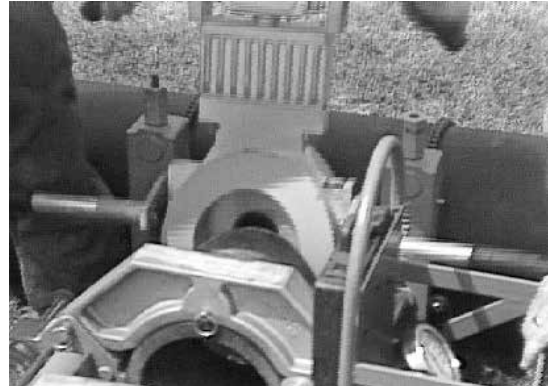

PH00404-9-21-94

Fuse Fitting to Pipe

Quickly close the carriage bringing the fitting and main together under the pipe manufacturer's recommended pressure or appropriate joining standard.

TX04030-4-12-10



PH00403-9-21-94

Allow Joint to Cool

Allow the joint to cool under pressure as specified by the pipe manufacturer's recommendation or appropriate joining standard. To maintain fusion pressure during cooling, the carriage control valve must be positioned in the right hand direction.

TX00467-3-30-11



PH00405-9-21-94

Special Operations - Lifting

Lifting Safety

Follow all applicable federal, state, local, and industry specific regulations when lifting.

⚠️WARNING

Safety warnings:

1. Do not exceed rated load or lift loads greater than the rated load of the lifting device.
2. Do not operate a damaged or malfunctioning lifting device.
3. Do not lift persons.
4. Do not lift a suspended load over persons.
5. Do not leave a suspended load unattended.
6. Do not remove or obscure warning labels.
7. Read and understand the lifting device operator's manual before use.
8. Stay clear of the suspended load.
9. Lift loads only as high as necessary.
10. Do not alter or modify the lifting device.
11. Employ generally accepted safe lifting practices.
12. Do not shock or impact load the lifting device.
13. Inspect all lifting pins for damage.



SAFE1st-12-14-92

WR00014-3-8-93

Maintenance

Preventative Maintenance

To insure optimum performance, the machine must be kept clean and well maintained.

With reasonable care, this machine will give years of service. Therefore, it is important that a regular schedule of preventive maintenance be kept.

Store machine inside, out of the weather, whenever possible.

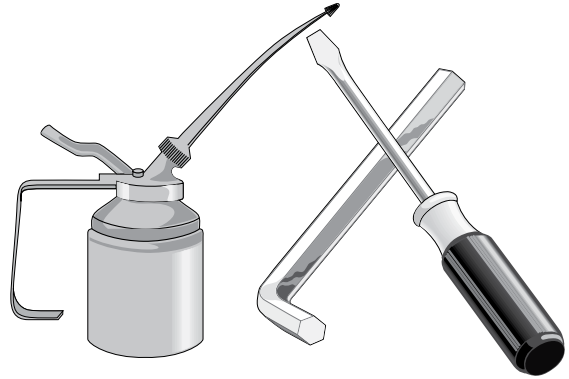

CD00142-11-2-94

TX00428-8-10-95

Washing the Machine

Cover plugs and electrical control boxes before washing.

The machine should be cleaned, as needed with a soap and water wash.

Do not pressure wash.



CD00178-9-15-95

TX00429-03-31-16

Check Hydraulic Fluid

The hydraulic fluid level should be checked daily.

If hydraulic fluid is not visible in the sight gauge, fluid must be added between top and bottom of the sight gauge.

Refer to the "Hydraulic Fluids" section of this manual for hydraulic fluid recommendations.

Never allow dirt, water, or other foreign matter to enter the tank.

Use only clean oil from an unopened container.



PH02974-3-08-05

TX02273-05-06-14

Change Hydraulic Fluid and Filter

The hydraulic filter should be replaced when the indicator gauge reads between 20 psi (138 kPa) and 25 psi (172 kPa) (yellow range).

Fluid should also be changed as extreme weather conditions dictate.

Refer to the "Hydraulic Fluids" section of this manual for hydraulic fluid recommendations.

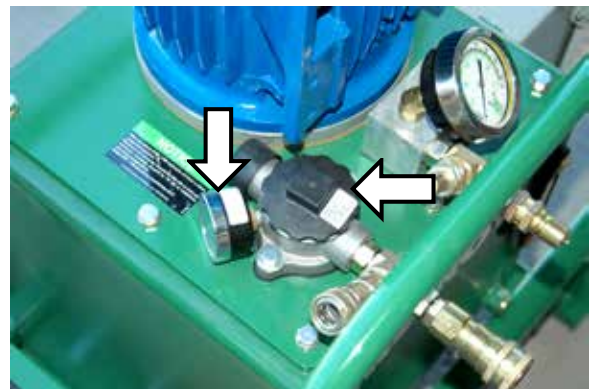

PH02975-3-18-05

TX02274-3-8-04

Maintenance

Check Gauges

Gauges should be checked daily.
The gauge should read zero when the unit is not running.
Damaged gauges should be replaced.

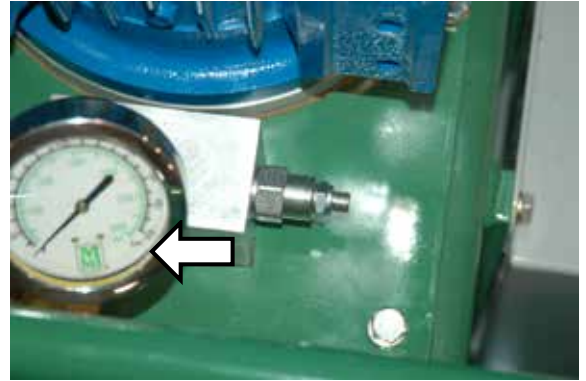

PH02977-3-18-05

TX02291-3-8-04

Clean Jaws and Inserts

To prevent slippage and insure proper alignment, the jaws and inserts must be clean.
Clean the jaws and inserts of any dirt or residual material using a stiff-bristled brush.



PH02687-3-8-04

TX00433-9-15-94

Clean Thrust Bearings

The thrust bearings located in the clamp knobs must turn freely.
Wash the clamp knob bearing assembly with a solvent, and then lubricate with 30W or lighter oil.

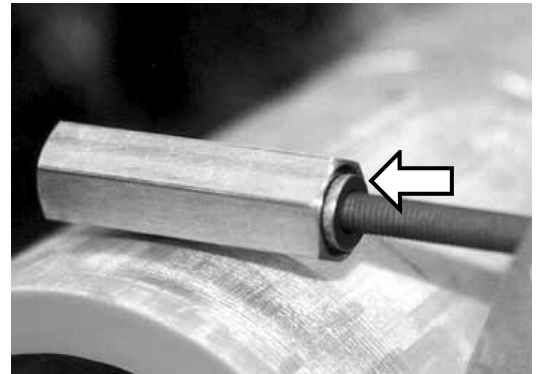

PH00377-9-14-94

TX00434-9-13-94

Clean Eyebolt Threads

Keep the clamp knob eyebolt threads brushed clean.

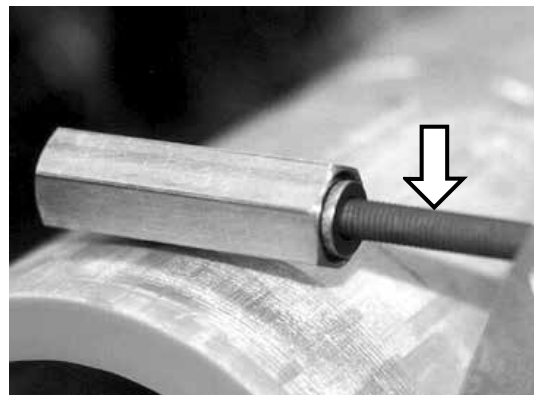

PH00377-9-14-94

TX00435-9-13-94

Maintenance

Fasteners Must Be Tight

Check all nuts, bolts, and snap rings to make certain they are secure and in place.



PH00805-4-10-96

TX00437-9-13-94

Facer

The facer should be lubricated annually.



PH02663-3-8-04

TX00438-9-15-94

Facer Blades

Blades bolt directly to the blade holder and should be inspected for damage and sharpness.

Dull or chipped blades must be replaced.

NOTICE: Never extend the blade beyond the inner or outer circumference of the facer.

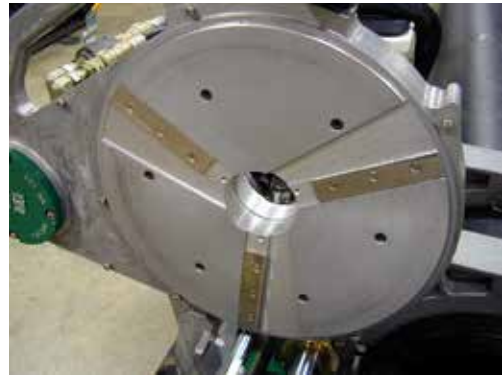

PH01912-11-15-00

TX02475-3-29-05

Clean Heater Surfaces

The heater faces must be kept clean and free of any plastic build up or contamination.

Before each fusion joint the heater surfaces must be wiped with a clean, non-synthetic cloth.

NOTICE: Do not use an abrasive pad or steel wool. Use a non-synthetic cloth that won't damage surfaces.



The heater is hot and will burn clothing and skin. Keep the heater in its insulated heater shroud when not in use, and use care when heating the pipe.



PH02333-7-08-02

TX00440-3-30-11

Maintenance

Bleeding Air From Hydraulic System

The two carriage cylinders have air bleed screws and must be bled if the system ever runs low on oil or leaks air on inlet side of pump. Air in the system is indicated when carriage movement becomes jerky and erratic. To bleed the system, proceed as follows:

Remove upper jaws & clamping eye bolts from the two movable clamp jaws to expose the bleed plugs recessed in top of the lower jaws.

Tilt machine so the fixed jaw end is higher than the opposite end.

Shift the directional control and move the carriage to the fixed jaw end. Adjust the pressure to approximately 50-100 psi (345-690 kPa) before proceeding.

Loosen the bleed plug on one cylinder next to the fixed jaw.

Hold pressure on the cylinder until no air is indicated and quickly tighten the plug.

Repeat this operation on the opposite cylinder.

Tilt the machine so the opposite end is higher than the fixed jaw end. Move the carriage to the end opposite the fixed jaw and repeat the above procedure on the this end of the cylinders.



PH01991-11-15-00

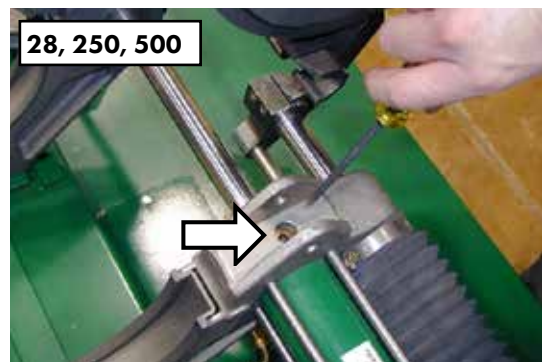

PH01992-11-15-00

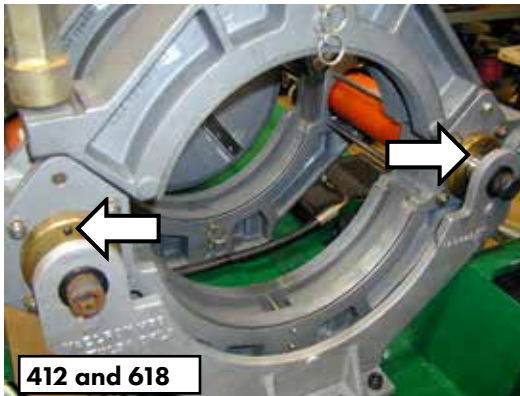

PH01994-11-15-00

TX00427-9-15-94

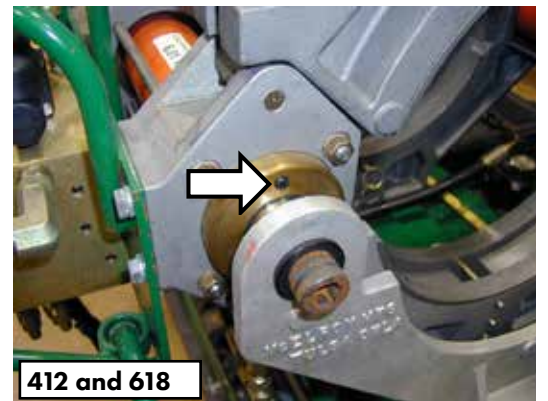

PH01993-11-15-00

Installing Butt Fusion Heater Plates

Coated butt fusion heater plates are available for all non-coated heaters.

Butt fusion heater plates are installed with stainless steel cap screws.

Install butt fusion heater plates while the heater is cool.

Care should be taken to assure that the butt fusion heater plates are seated on the heater body, and that there is no foreign matter trapped between these surfaces.

IMPORTANT: Do not over tighten the bolts.

The surface of the butt fusion heater plates are coated with an antistick coating.



PH02333-7-08-02

TX02716-11-30-10

Maintenance

Adjusting Heater Temperature

Turn knob to desired temperature. Measure the heater surface temperature with a pyrometer. Any variance must be corrected to the pyrometer reading.

Loosen setscrew in the knob. Turn knob to point to the same temperature as the pyrometer. Tighten setscrew in the knob.

Turn knob to desired temperature. Allow heater to stabilize at the new temperature (5 to 10 minutes) after adjusting. The thermometer on the heater body indicates internal temperature and should be used as a reference only.



PH02313-3-8-04

TX02034-7-08-02

Heater Indicator Light

The heater has a green indicator light which will flash on and off. This indicates that the controller is operating normally. If the green indicator is not flashing then the controller may not be operating properly. If this occurs, disconnect power and have the heater repaired by an McElroy Authorized Service Center.

The heater has a red indicator light on the handle at the bottom of the temperature scale. When the heater is plugged in and preheating the red light glows steadily until the set temperature is reached. The red light then goes off and on as the heater maintains temperature.

If the heater is not operating properly, the control will attempt to turn the heater off and the red indicator light will flash rapidly. If this occurs, disconnect the power and take it to a McElroy Authorized Service Center for repair.



PH02314-3-8-04

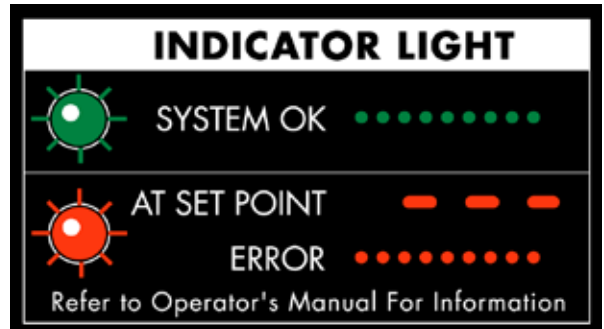

PH02571-3-8-04

TX04036-4-12-10

Maintenance Checklist

Fusion Machine Checklist

Item to Check	Satisfactory	Needs Repair	Repair Comments
Machine is clean			
All pins and snap rings are in place			
All nuts and bolts are tight			
All identification placards and handles are in place			
All clamp knobs are lubricated and turn freely			
Cords and plugs are in good condition			
All hardware is on the basic machine			
Oil Reservoir is filled to correct level			
Machine is free of hydraulic leaks			
Hydraulic gauges reads correctly			
Hydraulic hoses are in good condition			
Jaws are properly aligned			
Facer pivot operates smoothly			
Facer operates smoothly			
Face-off is square			
Inserts fit and pin properly			
Pump pressure can be adjusted			
Carriage and Selector Valves operate smoothly			
Pressure Reducing Valves operate in their range			
Heater			
Cord and plug are in good condition			
Heater surface is clean and in good condition			
Thermometer is in good working order			
Surface temperature checked with pyrometer			

TX02276-3-8-04

Determining Fusion Pressure

Variable Definitions

- O.D. = Outside Diameter of Pipe (inch)
 t = Wall Thickness of Pipe (inch)
 Π = 3.14
 SDR = Standard Dimensional Ratio of Pipe (unitless)
 IFP = Interfacial Pressure of Pipe (PSI)
 TEPA = Total Effective Piston Area of Carriage Cylinders (inch²)

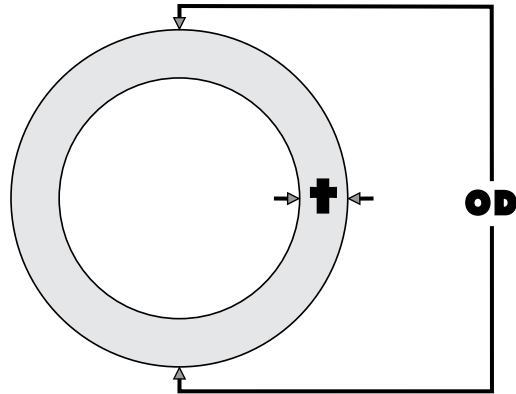

Formulas

$$t = \frac{\text{O.D.}}{\text{SDR}}$$

$$\text{PIPE AREA} = (\text{O.D.} - t) \times t \times \Pi$$

$$\text{FUSION FORCE} = \text{AREA} \times \text{IFP}$$

$$\text{GAUGE PRESSURE} = \frac{\text{FUSION FORCE}}{\text{TEPA}} + \text{DRAG}$$

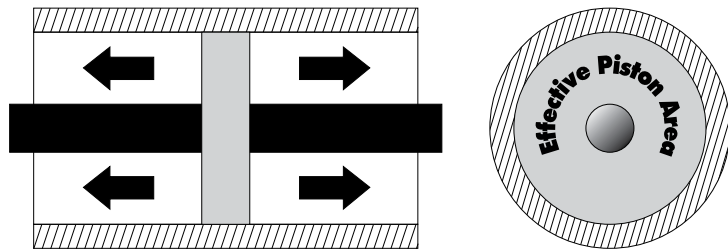

Example

- Pipe Size = 8" IPS, SDR 11
 O.D. = 8.625 inch
 DRAG = as measured in PSI (for this example use 30 PSI)
 Recommended IFP = 75 PSI
 Using a Model 28 High Force Fusion Unit

$$t = \frac{\text{O.D.}}{\text{SDR}} = \frac{8.625}{11} = 0.784$$

TEPA = 4.71 (From Table)

$$\text{GAUGE PRESSURE} = \frac{(\text{O.D.} - t) \times t \times \Pi \times \text{IFP}}{\text{TEPA}} + \text{DRAG}$$

$$\text{GAUGE PRESSURE} = \frac{(8.625 - .784) \times .784 \times 3.14 \times 75}{4.71} + 30 \text{ PSI} = 338 \text{ PSI}$$

Total Effective Piston Areas (in²)

Fusion Model	High Force	Medium	Low Force
A160/A250	-	-	0.90
28	4.71	3.24	1.66
250	4.71	3.24	1.66
412	11.78	6.01	3.14
618	11.78	6.01	3.14
500	-	6.01	3.14
824/T630	29.44	15.32	9.43
1236/T900	29.44	15.32	9.43
1648/T1200	31.42	14.14	-
2065	31.42	-	-
1600	31.42	14.14	-
2000	32.99	-	-

Determining Fusion Pressure - Sidewall

Variable Definitions

- O.D. = Outside Diameter of Base (not branch)
 t = Wall Thickness
 Π = 3.1416
 SDR = Standard Dimensional Ratio
 IFP = Manufacturer's Recommended Interfacial Pressure
 TEPA = Total Effective Piston Area

Formulas

$$t = \frac{\text{O.D.}}{\text{SDR}}$$

$$\text{AREA} = (\text{O.D.} - t) \times t \times \Pi$$

$$\text{FORCE} = \text{AREA} \times \text{IFP}$$

- IFP = 60 PSI for Bead-up
 0 PSI for Heat/Soak
 30 PSI for Saddle Fusion

ROUND BASE

$$\frac{(\text{O.D.} - t) \times t \times \Pi \times \text{IFP}}{\text{TEPA}}$$

RECTANGULAR BASE

$$\frac{[L \times W - (d \times d \times 0.7854)] \times \text{IFP}}{\text{TEPA}}$$

Example

O.D. of Base = 7.36"

t = 1.10"

DRAG = as measured in PSI (30 PSI for this example)

30 PSI for Saddle Fusion (must calculate for other IFP's also).

Using 28 Combination Unit and calculating the fusion pressure

$$\frac{(\text{O.D.} - t) \times t \times \Pi \times \text{IFP}}{\text{TEPA}} + \text{DRAG}$$

$$\frac{(7.36 - 1.10) \times 1.10 \times 3.14 \times 30}{4.71} + 30 \text{ PSI}$$

$$\frac{648.66}{4.71} + 30 \text{ PSI} = \mathbf{168 \text{ PSI Fusion Pressure}}$$

Using the same formula substitute the IFP with the IFP appropriate for the process and recalculate for each

Heat Soak Pressure for this example = **30 PSI**

Bead-up Pressure for this example = **306 PSI**

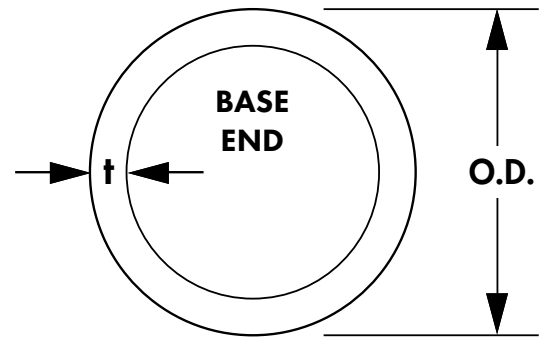

ROUND BASE

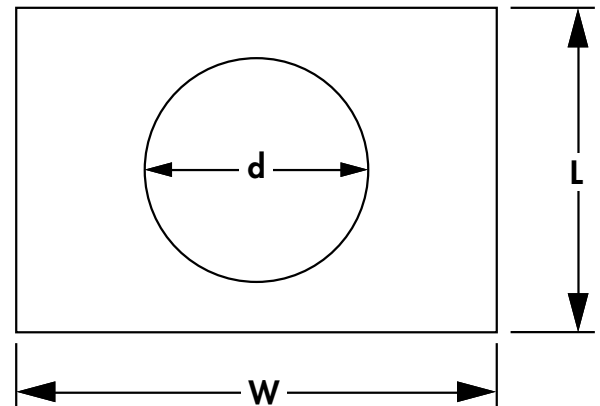

RECTANGULAR BASE

Total Effective Piston Areas			
Fusion Model	High Force (Standard)	Medium Force (High Velocity)	Low Force Extra High Velocity
Sidewinder	1.00		
28 CU	4.71	-	1.66
28 EP Sidewall	-	-	1.66
18 Sidewall	11.80	-	-
36 Sidewall	11.00	-	-

Hydraulic Fluids

Hydraulic Fluids

The use of proper hydraulic fluid is mandatory to achieve maximum performance and machine life. Use a clean, high quality, anti-wear hydraulic fluid with a viscosity index (VI) of 135 minimum. It should have a maximum viscosity of 500 cSt (2000 SSU) at startup (ambient temperature) and a minimum viscosity of 13 cSt (65 SSU) at the maximum fluid temperature (generally 80°F above ambient). Using hydraulic fluids that do not meet these criteria may cause poor operation and/or damage to the hydraulic components.

The following table specifies the fluid temperature at various viscosities. Temperature rise of the hydraulic fluid can vary from 30° F to about 80° F over the ambient temperature depending on the pressure setting, age of the pump, wind, etc. Mobil Univis N46 hydraulic fluid is installed at our factory. The advantage of this fluid is a wider temperature range, however, this fluid should not be used for continuous operation below 24°F.

TX03082-04-18-16

Hydraulic Fluids Characteristics																	
Manufacturer	Fluid Name	cSt 100F	cSt 210F	V.I.	-20F	-10F	0F	10F	30F	50F	70F	90F	110F	130F	150F	Range °F	Range °C
Mobil	DTE 10 Excel 15	15.8	4.1	168	****	*****	*****	*****	*****	*****	*****	*****	*****		-16 - 113	-27 - 45	
	DTE 10 Excel 32	32.7	6.6	164				*****	*****	*****	*****	*****	*****	*****	12 - 154	-11 - 68	
	DTE 10 Excel 46	45.6	8.5	164				*****	*****	*****	*****	*****	*****	*****	23 - 173	-5 - 78	
	DTE 10 Excel 68	68.4	11.2	156				*****	*****	*****	*****	*****	*****	*****	37 - 196	3 - 91	
	Univis N-32	34.9	6.9	164				*****	*****	*****	*****	*****	*****	*****	12 - 150	-11 - 66	
	Univis N-46	46	8.5	163				*****	*****	*****	*****	*****	*****	*****	24 - 166	-4 - 74	
	Univis N-68	73.8	12.1	160				****	*****	*****	*****	*****	*****	*****	39 - 193	4 - 89	

NOTE: This chart is based on pump manufacturer recommendations of 13 to 500 cSt.

NOTE: Temperatures shown are fluid temperatures. – NOT ambient temperatures.

Specifications

EP1500P (Pit Bull HPU) Specifications

Pump flow rate: 6.1 gpm (23.1 lpm) @ 60 Hz

5.0 gpm (18.9 lpm) @ 50 Hz

Design Pressure: 1500 psi (103 bar)

Weight: 390 lbs (177 kg)

Filtration: 10 micron absolute

Reservoir capacity: 10 gallons (37 liters)

Hydraulic fluid: see Hydraulic Fluid Section

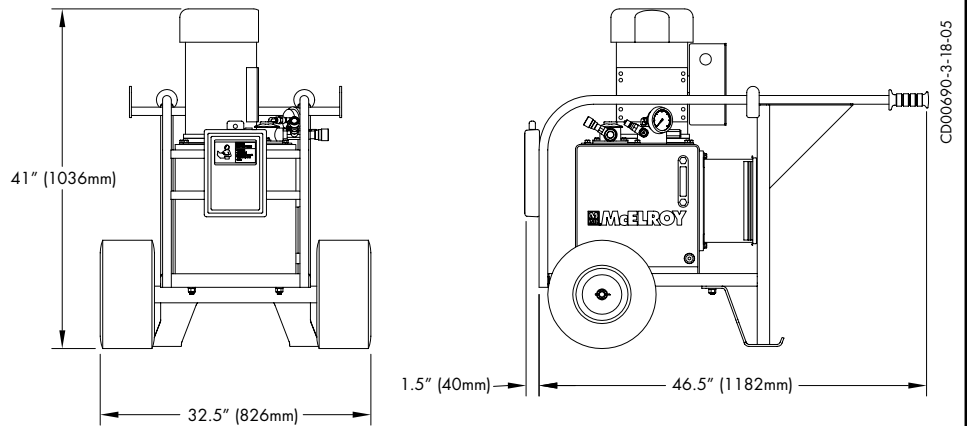

Voltage	Frequency	Phases	Power Requirement
240V	60Hz	1Ph	7.9KVA/7.8KW
220-240V	50/60Hz	3Ph	8.2KVA/7.5KW
380-415V	50Hz	3Ph	8.2KVA/7.5KW

Hydraulic Fluids

Pit Bull Carriage Specifications

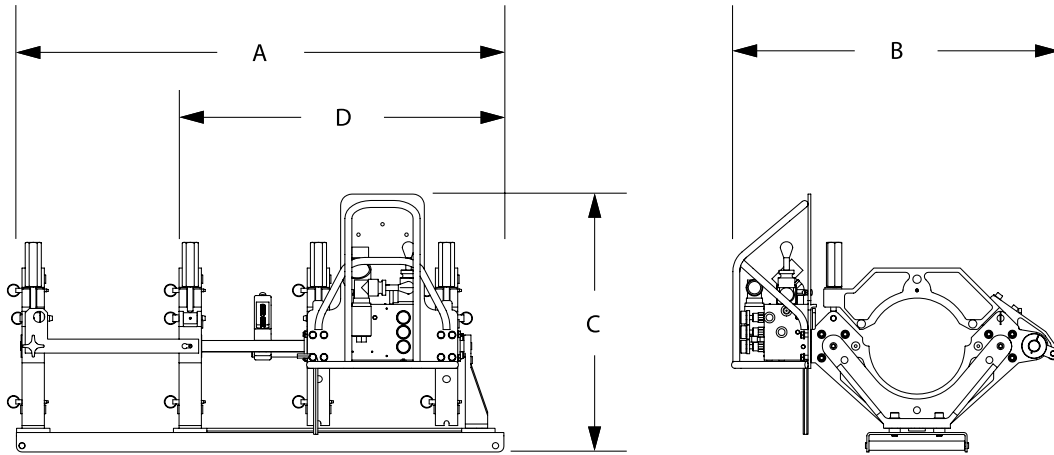

CD00662-3-8-04

Pit Bull model	Minimum Pipe Size	Maximum Pipe Size	Weights lbs (kg)			Heater Power Watts	Dimensions in (mm)			
			Carriage	Facer	Heater/ with Bag		A	B	C	D
28	2" IPS (63mm)	8" DIPS (225 mm)	257* (117)	44 (19.9)	21/42 (9.5/19)	1750	44 (1118)	30 (762)	23 (584)	30 (762)
250	2" IPS (63mm)	250mm	255* (116)	44 (19.9)	21/42 (9.5/19)	3000	44 (1118)	30 (762)	23 (584)	30 (762)
412	4" IPS (110mm)	12" DIPS (340mm)	425* (193)	62 (28.1)	24/44 (10.9/19.9)	3000	44 (1118)	30 (762)	27 (686)	29 (737)
618	6" IPS (180mm)	18" OD (450mm)	595* (270)	94 (42.6)	34/58 (15.4/26)	3000	44 (1118)	43 (1092)	33 (838)	29 (737)
500	6" IPS (180mm)	20" OD (500mm)	390 (177)	84 (38.1)	40 (18)	4000	40 (1016)	39 (991)	28 (711)	29 (737)

* Carriage weights include detachable facer

CD01850-01-10-19

For 412 and 618 carriages with Hydraulic Clamping, add 40 lbs. (18 Kg)

Specifications

Generator Sizing Form

Complete this form and provide a copy to your generator supplier. This information will enable your generator supplier to correctly size a generator for your application.

Motor: 5 Horsepower

Motor Code Letter: _____ (from motor nameplate should be J or K)

Motor Voltage: _____ See HPU nameplate for voltage

Motor Phases: 1 or 3 Phase

Motor Frequency: _____ (50 or 60 Hz)

Heater Wattage Rating: _____ Watts resistive

Heater Voltage: _____ See label on heater for voltage

Operational Altitude Range: _____ to _____

Ambient Temperature Range: _____ to _____

Duty Cycle: Standby (Not continuous 24 hours/day)

Allowable Voltage Dip: 20%

Allowable Frequency Dip: 5%

Starting Load Application: Simultaneous turn-on of both motor and heater.

Running Load: Motor continuous, heater cycling on and off at approximately 5 minute intervals.

Fuel: _____ (Gasoline or Diesel)

Special requirements for customer application: _____

About this manual . . .

McElroy Manufacturing continually strives to give customers the best quality products available. This manual is printed with materials made for durable applications and harsh environments.

This manual is waterproof, tear resistant, grease resistant, abrasion resistant and the bonding quality of the printing ensures a readable, durable product.

The material does not contain any cellulose based materials and does not contribute to the harvesting of our forests, or ozone-depleting constituents. This manual can be safely disposed of in a landfill and will not leach into ground water.



P.O. Box 580550 Tulsa, Oklahoma 74158-0550, USA

www.mcelroy.com